



State of West Virginia  
 Department of Administration  
 Purchasing Division  
 2019 Washington Street East  
 Post Office Box 50130  
 Charleston, WV 25305-0130

# Request for Quotation

RFQ NUMBER  
**DEP13572**

PAGE  
**1**

ADDRESS CORRESPONDENCE TO ATTENTION OF  
**CHUCK BOWMAN**  
**304-558-2157**

VENDOR

RFQ COPY  
 TYPE NAME/ADDRESS HERE  
**501151933**  
**MIDWAY RECLAMATION, LLC.**  
**P.O. BOX 308**  
**WEST MILFORD, WV 26451**

SHIP TO

**ENVIRONMENTAL PROTECTION**  
**DEPT. OF**  
**OFFICE OF SPECIAL RECLAMATION**  
**105 S. RAILROAD STREET**  
**PHILIPPI, WV**  
**26416-9998 304-457-3219**

DATE PRINTED	TERMS OF SALE	SHIP VIA	F.O.B.	FREIGHT TERMS
02/08/2007				

BID OPENING DATE: **03/22/2007** BID OPENING TIME **01:30PM**

LINE	QUANTITY	UOP	CAT NO	ITEM NUMBER	UNIT PRICE	AMOUNT
0001	1	JB		962-73		\$164,876.00
<p><b>RECLAMATION: RESTORATION OF LAND/ WATER</b></p> <p>THE WEST VIRGINIA PURCHASING DIVISION, ON BEHALF OF THE AGENCY, THE WEST VIRGINIA DEPARTMENT OF ENVIRONMENTAL PROTECTION, IS SOLICITING BIDS PER THE SPECIFICATIONS AS NOTED BELOW AND ATTACHED.</p> <p><b>SPECIAL RECLAMATION/BOND FORFEITURE PROJECT</b></p> <p>THE PURPOSE OF THE CONTRACT IS TO PERFORM WATER RECLAMATION ON THE MINING OPERATION OF MOHIGAN MINING COMPANY, NOW UNDER REVOKED PERMIT NUMBER(S) U-109-83.</p> <p>THE RECLAMATION SHALL BE PERFORMED UNDER THE GUIDANCE AND GENERAL SUPERVISION OF THE AGENT ASSIGNED TO THE PROJECT FOR THE STATE OF WEST VIRGINIA, DEPARTMENT OF ENVIRONMENTAL PROTECTION.</p> <p>A MANDATORY ON SITE PREBID CONFERENCE SHALL BE HELD ON 02/28/07 @ 10:00 AM. FAILURE TO ATTEND THE PREBID CONFERENCE WILL RESULT IN BID DISQUALIFICATION.</p> <p>THE CONTRACTOR SHALL PROVIDE ALL LABOR, MATERIALS, EQUIPMENT AND OTHER NECESSARY SERVICES SO AS TO ACCOMPLISH THE ITEMS AS SPECIFIED IN THIS CONTRACT. PROJECT IS LOCATED NEAR EVERETTVILLE IN MONONGALIA COUNTY (OFF COUNTY ROUTE 45) AND CONSISTS OF APPROXIMATELY 3 ACRES.</p> <p>PROJECT CONTACT PERSON:</p>						

SEE REVERSE SIDE FOR TERMS AND CONDITIONS

SIGNATURE <i>Nancy S. Somers</i>	TELEPHONE <b>304-745-3652</b>	DATE <b>03-22-07</b>
TITLE <b>OWNER</b>	FEBN <b>33-1135400</b>	ADDRESS CHANGES TO BE NOTED ABOVE

WHEN RESPONDING TO RFQ, INSERT NAME AND ADDRESS IN SPACE ABOVE LABELED 'VENDOR'

**GENERAL TERMS & CONDITIONS  
REQUEST FOR QUOTATION (RFQ) AND REQUEST FOR PROPOSAL (RFP)**

1. Awards will be made in the best interest of the State of West Virginia
2. The State may accept or reject in part, or in whole, any bid
3. All quotations are governed by the *West Virginia Code* and the *Legislative Rules* of the Purchasing Division
4. Prior to any award, the apparent successful vendor must be properly registered with the Purchasing Division and have paid the required \$125.00 registration fee
5. All services performed or goods delivered under State Purchase Orders/Contracts are to be continued for the term of the Purchase Order/Contract, contingent upon funds being appropriated by the Legislature or otherwise being made available. In the event funds are not appropriated or otherwise available for these services or goods, this Purchase Order/Contract becomes void and of no effect after June 30
6. Payment may only be made after the delivery and acceptance of goods or services
7. Interest may be paid for late payment in accordance with the *West Virginia Code*
8. Vendor preference will be granted upon written request in accordance with the *West Virginia Code*.
9. The State of West Virginia is exempt from federal and state taxes and will not pay or reimburse such taxes
10. The Director of Purchasing may cancel any Purchase Order/Contract upon 30 days written notice to the seller
11. The laws of the State of West Virginia and the *Legislative Rules* of the Purchasing Division shall govern all rights and duties under the Contract, including without limitation the validity of this Purchase Order/Contract
12. Any reference to automatic renewal is hereby deleted. The Contract may be renewed only upon mutual written agreement of the parties
13. **BANKRUPTCY:** In the event the vendor/contractor files for bankruptcy protection, this contract is automatically null and void, and is terminated without further order
14. **HIPAA Business Associate Addendum** - The West Virginia State Government HIPAA Business Associate Addendum (BAA), approved by the Attorney General, and available online at the Purchasing Division's web site (<http://www.state.wv.us/admin/purchase/vrc/hipaa.htm>) is hereby made part of the agreement. Provided that, the Agency meets the definition of a Covered Entity (45 CFR §160.103) and will be disclosing Protected Health Information (45 CFR §160.103) to the vendor

---

**INSTRUCTIONS TO BIDDERS**

1. Use the quotation forms provided by the Purchasing Division
2. **SPECIFICATIONS:** Items offered must be in compliance with the specifications. Any deviation from the specifications must be clearly indicated by the bidder. Alternates offered by the bidder as **EQUAL** to the specifications must be clearly defined. A bidder offering an alternate should attach complete specifications and literature to the bid. The Purchasing Division may waive minor deviations to specifications
3. Complete all sections of the quotation form
4. Unit prices shall prevail in cases of discrepancy
5. All quotations are considered F O B destination unless alternate shipping terms are clearly identified in the quotation
6. **BID SUBMISSION:** All quotations must be delivered by the bidder to the office listed below prior to the date and time of the bid opening. Failure of the bidder to deliver the quotations on time will result in bid disqualifications

**SIGNED BID TO:**

Department of Administration  
Purchasing Division  
2019 Washington Street East  
Post Office Box 50130  
Charleston, WV 25305-0130



State of West Virginia  
 Department of Administration  
 Purchasing Division  
 2019 Washington Street East  
 Post Office Box 50130  
 Charleston, WV 25305-0130

# Request for Quotation

RFQ NUMBER:  
**DEP13572**

PAGE:  
**2**

ADDRESS CORRESPONDENCE TO ATTENTION OF:  
**CHUCK BOWMAN  
 304-558-2157**

VENDOR

RFQ COPY  
 TYPE NAME/ADDRESS HERE  
**501151933**  
**MIDWAY RECLAMATION, LLC.**  
**P.O. BOX 308**  
**WEST MILFORD, WV 26451**

SHIP TO

**ENVIRONMENTAL PROTECTION  
 DEPT. OF  
 OFFICE OF SPECIAL RECLAMATION  
 105 S. RAILROAD STREET  
 PHILIPPI, WV  
 26416-9998 304-457-3219**

DATE PRINTED	TERMS OF SALE	SHIP VIA	F.O.B.	FREIGHT TERMS
02/08/2007				

BID OPENING DATE: **03/22/2007** BID OPENING TIME **01:30PM**

LINE	QUANTITY	UOP	CAT NO.	ITEM NUMBER	UNIT PRICE	AMOUNT
<p>ATTN: JIMMIE B. SECKMAN JR.            DEPT. OF ENVIRONMENTAL PROTECTION/DLR/SPECIAL REC.            105 S RAILROAD STREET, SUITE 301            PHILIPPI, WV 26416 (304) 457-4588 EXT. 3260</p> <p>ALL WORK MUST BE COMPLETED IN ACCORDANCE WITH THE PLANS AND SPECIFICATIONS PREPARED BY THE DEPARTMENT OF ENVIRONMENTAL PROTECTION AND PURCHASE ORDER ISSUED BY THE DEPARTMENT OF ADMINISTRATION, PURCHASING DIVISION.</p> <p>EXHIBIT 5</p> <p>NOTICE TO PROCEED: THIS CONTRACT IS TO BE PERFORMED WITHIN 365 CALENDAR DAYS AFTER THE NOTICE TO PROCEED IS RECEIVED. UNLESS OTHERWISE SPECIFIED, THE FULLY EXECUTED PURCHASE ORDER WILL BE CONSIDERED NOTICE TO PROCEED.</p> <p>CANCELLATION: THE DIRECTOR OF PURCHASING RESERVES THE RIGHT TO CANCEL THIS CONTRACT IMMEDIATELY UPON WRITTEN NOTICE TO THE VENDOR IF THE MATERIALS OR WORKMANSHIP SUPPLIED ARE OF AN INFERIOR QUALITY OR DO NOT CONFORM WITH THE SPECIFICATIONS OF THE THE BID AND CONTRACT HEREIN.</p> <p>WAGE RATES: THE CONTRACTOR OR SUBCONTRACTOR SHALL PAY THE HIGHER OF THE U.S. DEPARTMENT OF LABOR MINIMUM WAGE RATES AS ESTABLISHED FOR MONONGALIA COUNTY, PURSUANT TO WEST VIRGINIA CODE 21-5A, ET,SEQ.</p> <p>ARBITRATION: ANY REFERENCES MADE TO ARBITRATION OR INTEREST FOR PAYMENTS DUE (EXCEPT FOR ANY INTEREST REQUIRED BY STATE LAW) CONTAINED IN THIS CONTRACT OR IN ANY AMERICAN INSTITUTE OF ARCHITECTS DOCUMENTS PERTAINING TO THIS CONTRACT ARE HEREBY DELETED.</p>						

SEE REVERSE SIDE FOR TERMS AND CONDITIONS

SIGNATURE <i>Perry A. Lewis</i>	TELEPHONE <b>304-745-3652</b>	DATE <b>03-22-07</b>
TITLE <b>OWNER</b>	FEIN <b>33-1135400</b>	ADDRESS CHANGES TO BE NOTED ABOVE

WHEN RESPONDING TO RFQ, INSERT NAME AND ADDRESS IN SPACE ABOVE LABELED 'VENDOR'



State of West Virginia  
 Department of Administration  
 Purchasing Division  
 2019 Washington Street East  
 Post Office Box 50130  
 Charleston, WV 25305-0130

# Request for Quotation

RFQ NUMBER  
**DEP13572**

PAGE  
**3**

ADDRESS CORRESPONDENCE TO ATTENTION OF  
**CHUCK BOWMAN**  
**304-558-2157**

RFQ COPY

TYPE NAME/ADDRESS HERE

**501151933**  
**MIDWAY RECLAMATION, LLC.**  
**P.O. BOX 308**  
**WEST MILFORD, WV 26451**

SHIP TO

**ENVIRONMENTAL PROTECTION**  
**DEPT. OF**  
**OFFICE OF SPECIAL RECLAMATION**  
**105 S. RAILROAD STREET**  
**PHILIPPI, WV**  
**26416-9998 304-457-3219**

DATE PRINTED	TERMS OF SALE	SHIP VIA	F.O.B.	FREIGHT TERMS
02/08/2007				

BID OPENING DATE: **03/22/2007** BID OPENING TIME **01:30PM**

LINE	QUANTITY	UOP	CAT NO	ITEM NUMBER	UNIT PRICE	AMOUNT
<p><b>WORKERS' COMPENSATION: VENDOR IS REQUIRED TO PROVIDE A CERTIFICATE FROM WORKERS' COMPENSATION IF SUCCESSFUL.</b></p> <p><b>ALL OF THE ITEMS CHECKED BELOW WILL BE A REQUIREMENT OF THIS CONTRACT:</b></p> <p><b>(XX) INSURANCE: SUCCESSFUL VENDOR SHALL FURNISH PROOF OF COMMERCIAL GENERAL LIABILITY INSURANCE PRIOR TO ISSUANCE OF CONTRACT. UNLESS OTHERWISE SPECIFIED IN THE BID DOCUMENTS, THE MINIMUM AMOUNT OF INSURANCE COVERAGE REQUIRED IS \$250,000.</b></p> <p><b>( ) BUILDERS RISK INSURANCE: SUCCESSFUL VENDOR SHALL FURNISH PROOF OF BUILDERS RISK - ALL RISK INSURANCE IN AN AMOUNT EQUAL TO 100% OF THE AMOUNT OF THE CONTRACT.</b></p> <p><b>(XX) BONDS: FIVE PERCENT (5%) OF THE TOTAL AMOUNT OF THE BID PAYABLE TO THE STATE OF WEST VIRGINIA, SHALL BE SUBMITTED WITH EACH BID AS A BID BOND. THE SUCCESSFUL BIDDER SHALL ALSO FURNISH A PERFORMANCE BOND AND LABOR/MATERIAL BOND FOR 100% OF THE AMOUNT OF THE CONTRACT. BONDS MAY BE PROVIDED IN THE FORM OF A CERTIFIED CHECK IRREVOCABLE LETTER OF CREDIT, OR BOND FURNISHED BY A SOLVENT SURETY COMPANY AUTHORIZED TO DO BUSINESS IN THE STATE OF WEST VIRGINIA. A LETTER OF CREDIT SUBMITTED IN LIEU OF A PERFORMANCE AND LABOR &amp; MATERIAL BOND WILL ONLY BE ALLOWED FOR PROJECTS UNDER \$100,000. PERSONAL OR BUSINESS CHECKS ARE NOT ACCEPTABLE IN LIEU OF THE 5% BID BOND, PERFORMANCE BOND, OR LABOR/MATERIAL BOND.</b></p> <p><b>( ) MAINTENANCE BOND: A TWO (2) YEAR MAINTENANCE BOND COVERING THE ROOFING SYSTEM WILL BE A REQUIREMENT OF THE SUCCESSFUL VENDOR.</b></p>						

SEE REVERSE SIDE FOR TERMS AND CONDITIONS

SIGNATURE *Nancy A. Jones* TELEPHONE **304-745-3652** DATE **03-22-07**  
 TITLE **OWNER** FEIN **33-1135400** ADDRESS CHANGES TO BE NOTED ABOVE

WHEN RESPONDING TO RFQ, INSERT NAME AND ADDRESS IN SPACE ABOVE LABELED 'VENDOR'



State of West Virginia  
 Department of Administration  
 Purchasing Division  
 2019 Washington Street East  
 Post Office Box 50130  
 Charleston, WV 25305-0130

# Request for Quotation

RFQ NUMBER:  
**DEP13572**

PAGE:  
**4**

ADDRESS CORRESPONDENCE TO ATTENTION OF:  
**CHUCK BOWMAN  
 304-558-2157**

VENDOR

RFQ COPY  
 TYPE NAME/ADDRESS HERE  
**501151933**  
**MIDWAY RECLAMATION, LLC.**  
**PO BOX 308**  
**WEST MILFORD, WV 26451**

SPEL TO

**ENVIRONMENTAL PROTECTION  
 DEPT. OF  
 OFFICE OF SPECIAL RECLAMATION  
 105 S. RAILROAD STREET  
 PHILIPPI, WV  
 26416-9998 304-457-3219**

DATE PRINTED <b>02/08/2007</b>	TERMS OF SALE	SHIP VIA	F.O.B.	FREIGHT TERMS
-----------------------------------	---------------	----------	--------	---------------

BID OPENING DATE: **03/22/2007** BID OPENING TIME **01:30PM**

LINE	QUANTITY	UOF	CAT NO	ITEM NUMBER	UNIT PRICE	AMOUNT
	REV. 11/00			CONTRACTORS LICENSE		
<p>WEST VIRGINIA STATE CODE 21-11-2 REQUIRES THAT ALL PERSONS DESIRING TO PERFORM CONTRACTING WORK IN THIS STATE MUST BE LICENSED. THE WEST VIRGINIA CONTRACTORS LICENSING BOARD IS EMPOWERED TO ISSUE THE CONTRACTORS LICENSE. APPLICATIONS FOR A CONTRACTORS LICENSE MAY BE MADE BY CONTACTING THE WEST VIRGINIA DIVISION OF LABOR CAPITOL COMPLEX, BUILDING 3, ROOM 319, CHARLESTON, WV 25305. TELEPHONE: (304) 558-7890.</p> <p>WEST VIRGINIA STATE CODE 21-11-11 REQUIRES ANY PROSPECTIVE BIDDER TO INCLUDE THE CONTRACTORS LICENSE NUMBER ON THEIR BID.</p> <p>BIDDER TO COMPLETE:            CONTRACTORS NAME - <b>MIDWAY RECLAMATION LLC</b>            CONTRACTORS LICENSE NO. - <b>WV040515</b></p> <p>THE SUCCESSFUL BIDDER WILL REQUIRED TO FURNISH A COPY OF THEIR CONTRACTORS LICENSE PRIOR TO ISSUANCE OF A PURCHASE ORDER/CONTRACT.</p> <p>APPLICABLE LAW</p> <p>THE WEST VIRGINIA STATE CODE, PURCHASING DIVISION RULE AND REGULATIONS, AND THE INFORMATION PROVIDED IN THE "REQUEST FOR QUOTATION" ISSUED BY THE PURCHASING DIVISION IS THE SOLE AUTHORITY GOVERNING THIS PROCUREMENT.</p> <p>ANY INFORMATION PROVIDED IN SPECIFICATION MANUALS, OR</p>						

SEE REVERSE SIDE FOR TERMS AND CONDITIONS

SIGNATURE <i>Nancy S. Somers</i>	TELEPHONE <b>304-745-3652</b>	DATE <b>03-22-07</b>
TITLE <b>OWNER</b>	FEIN <b>33-1135400</b>	ADDRESS CHANGES TO BE NOTED ABOVE

WHEN RESPONDING TO RFQ, INSERT NAME AND ADDRESS IN SPACE ABOVE LABELED 'VENDOR'



State of West Virginia  
 Department of Administration  
 Purchasing Division  
 2019 Washington Street East  
 Post Office Box 50130  
 Charleston, WV 25305-0130

# Request for Quotation

RFQ NUMBER  
 DEP13572

PAGE  
 5

ADDRESS CORRESPONDENCE TO ATTENTION OF:  
 CHUCK BOWMAN  
 304-558-2157

VENDOR

RFQ COPY  
 TYPE NAME/ADDRESS HERE  
 501151933  
 MIDWAY RECLAMATION, LLC.  
 P.O. BOX 308  
 WEST MILFORD, WV 26451

SHIP TO

ENVIRONMENTAL PROTECTION  
 DEPT. OF  
 OFFICE OF SPECIAL RECLAMATION  
 105 S. RAILROAD STREET  
 PHILIPPI, WV  
 26416-9998 304-457-3219

DATE PRINTED 02/08/2007	TERMS OF SALE	SHIP VIA	FOB	FREIGHT TERMS
----------------------------	---------------	----------	-----	---------------

BID OPENING DATE: 03/22/2007 BID OPENING TIME 01:30PM

LINE	QUANTITY	UOP	CAT NO	ITEM NUMBER	UNIT PRICE	AMOUNT
<p>ANY OTHER SOURCE, VERBAL OR WRITTEN, WHICH CONTRADICTS OR ALTERS THE INFORMATION PROVIDED FROM THE SOURCES AS DESCRIBED IN THE ABOVE PARAGRAPH IS VOID AND OF NO EFFECT.</p> <p>BANKRUPTCY: IN THE EVENT THE VENDOR/CONTRACTOR FILES FOR BANKRUPTCY PROTECTION, THIS CONTRACT IS AUTOMATICALLY NULL AND VOID, AND IS TERMINATED WITHOUT FURTHER ORDER.</p> <p>EXHIBIT 7</p> <p>DOMESTIC ALUMINUM, GLASS &amp; STEEL IN PUBLIC WORKS PROJECTS</p> <p>IN ACCORDANCE WITH WEST VIRGINIA CODE 5-19-1 ET., SEQ., EVERY CONTRACT FOR CONSTRUCTION, RECONSTRUCTION, ALTERATION, REPAIR, IMPROVEMENT OR MAINTENANCE OF PUBLIC WORKS, WHERE THE COST IS MORE THAN \$50,000 AND, IN THE CASE OF STEEL ONLY, WHERE THE COST OF STEEL IS MORE THAN \$50,000 OR WHERE MORE THAN 10,000 POUNDS OF STEEL ARE REQUIRED, THE STATE WILL ACCEPT ONLY ALUMINUM GLASS, OR STEEL PRODUCTS PRODUCED IN THE UNITED STATES. IN ADDITION, ITEMS OF MACHINERY OR EQUIPMENT PURCHASED FOR USE AT THE SITE OF PUBLIC WORKS SHALL BE MADE OF DOMESTIC ALUMINUM, GLASS OR STEEL, UNLESS THE COST OF THE PRODUCT IS LESS THAN \$50,000 OR LESS THAN 10,000 POUNDS OF STEEL ARE USED IN PUBLIC WORKS PROJECTS.</p> <p>FOREIGN MADE ALUMINUM, GLASS OR STEEL PRODUCTS MAY BE ACCEPTED ONLY IF THE COST OF DOMESTIC PRODUCTS IS FOUND TO BE UNREASONABLE. SUCH COST IS UNREASONABLE IF IT IS %20 OR MORE HIGHER THAN THE BID PRICE FOR FOREIGN MADE PRODUCTS. IF THE DOMESTIC ALUMINUM, GLASS OR STEEL PRODUCTS TO BE SUPPLIED OR PRODUCED IN A "SUBSTANTIAL LABOR SURPLUS AREA", AS DEFINED BY THE UNITED STATES</p>						

SEE REVERSE SIDE FOR TERMS AND CONDITIONS

SIGNATURE <i>Nancy A. ...</i>	TELEPHONE 304-745-3652	DATE 03-22-07
TITLE OWNER	FEIN 33-1135400	ADDRESS CHANGES TO BE NOTED ABOVE

WHEN RESPONDING TO RFQ, INSERT NAME AND ADDRESS IN SPACE ABOVE LABELED 'VENDOR'



State of West Virginia  
 Department of Administration  
 Purchasing Division  
 2019 Washington Street East  
 Post Office Box 50130  
 Charleston, WV 25305-0130

# Request for Quotation

RFQ NUMBER  
 DEP13572

PAGE  
 6

ADDRESS CORRESPONDENCE TO ATTENTION OF  
 CHUCK BOWMAN  
 304-558-2157

VENDOR

RFQ COPY  
 TYPE NAME/ADDRESS HERE  
**501151933**  
 MIDWAY RECLAMATION, LLC.  
 P.O. BOX 308  
 WEST MILFORD, WV 26451

SHIP TO

ENVIRONMENTAL PROTECTION  
 DEPT. OF  
 OFFICE OF SPECIAL RECLAMATION  
 105 S. RAILROAD STREET  
 PHILIPPI, WV  
 26416-9998 304-457-3219

DATE PRINTED	TERMS OF SALE	SHIP VIA	F.O.B.	FREIGHT TERMS
02/08/2007				

BID OPENING DATE: **03/22/2007** BID OPENING TIME **01:30PM**

LINE	QUANTITY	UOP	CAT NO	ITEM NUMBER	UNIT PRICE	AMOUNT
<p>DEPARTMENT OF LABOR, FOREIGN PRODUCTS MAY BE SUPPLIED ONLY IF DOMESTIC PRODUCTS ARE %30 OR MORE HIGHER IN PRICE THAN THE FOREIGN MADE PRODUCTS.</p> <p>IF, PRIOR TO THE AWARD OF A CONTRACT UNDER THE ABOVE PROVISIONS, THE SPENDING OFFICER OF THE SPENDING UNIT DETERMINES THAT THERE EXISTS A BID FOR LIKE FOREIGN ALUMINUM, GLASS OR STEEL THAT IS REASONABLE AND LOWER THAN THE LOWEST BID FOR DOMESTIC PRODUCTS, THE SPENDING OFFICE MAY REQUEST, IN WRITING, A REEVALUATION AND REDUCTION IN THE LOWEST BID FOR SUCH DOMESTIC PRODUCTS. ALL VENDORS MUST INDICATE IN THEIR BID IF THEY ARE SUPPLYING FOREIGN ALUMINUM, GLASS OR STEEL.</p> <p>REV. 3/88</p> <p>EXHIBIT 9</p> <p>NOTICE FOR ISSUANCE &amp; ACKNOWLEDGEMENT OF CONSTRUCTION PROJECT ADDENDA</p> <p>THE ARCHITECT/ENGINEER AND/OR AGENCY SHALL BE REQUIRED TO ABIDE BY THE FOLLOWING SCHEDULE IN ISSUING CONSTRUCTION PROJECT ADDENDA FOR STATE AGENCIES:</p> <p>(1) THE ARCHITECT/ENGINEER SHALL PREPARE THE ADDENDUM AND A LIST OF ALL PARTIES THAT HAVE PROCURED DRAWINGS AND SPECIFICATIONS FOR THE PROJECT. THE ADDENDUM AND LIST SHALL BE FORWARDED TO THE BUYER IN THE STATE PURCHASING DIVISION. THE ARCHITECT/ENGINEER SHALL ALSO SEND A COPY OF THE ADDENDUM TO THE STATE AGENCY FOR WHICH THE CONTRACT IS ISSUED.</p> <p>(2) THE BUYER SHALL SEND THE ADDENDUM TO ALL INTERESTED PARTIES AND, IF NECESSARY, EXTEND THE BID</p>						

SEE REVERSE SIDE FOR TERMS AND CONDITIONS

SIGNATURE <i>Nancy L. Samers</i>	TELEPHONE 304-745-3652	DATE 03-22-07
TITLE OWNER	FEIN 33-1135400	ADDRESS CHANGES TO BE NOTED ABOVE

WHEN RESPONDING TO RFQ, INSERT NAME AND ADDRESS IN SPACE ABOVE LABELED 'VENDOR'



State of West Virginia  
 Department of Administration  
 Purchasing Division  
 2019 Washington Street East  
 Post Office Box 50130  
 Charleston, WV 25305-0130

# Request for Quotation

RFQ NUMBER  
**DEP13572**

PAGE  
**7**

ADDRESS CORRESPONDENCE TO ATTENTION OF:  
**CHUCK BOWMAN**  
**304-558-2157**

MIDWAY

RFQ COPY  
 TYPE NAME/ADDRESS HERE  
**501151933**  
**MIDWAY RECLAMATION, LLC.**  
**P.O. BOX 308**  
**WEST MILFORD, WV 26451**

SHIP TO

**ENVIRONMENTAL PROTECTION**  
**DEPT. OF**  
**OFFICE OF SPECIAL RECLAMATION**  
**105 S. RAILROAD STREET**  
**PHILIPPI, WV**  
**26416-9998 304-457-3219**

DATE PRINTED <b>02/08/2007</b>	TERMS OF SALE	SHIP VIA	F.O.B.	FREIGHT TERMS
-----------------------------------	---------------	----------	--------	---------------

BID OPENING DATE: **03/22/2007** BID OPENING TIME **01:30PM**

LINE	QUANTITY	UOP	CAT NO	ITEM NUMBER	UNIT PRICE	AMOUNT
<p>OPENING DATE. ANY ADDENDUM SHOULD BE RECEIVED BY THE BUYER WITHIN FOURTEEN (14) DAYS PRIOR TO THE BID OPENING DATE.</p> <p>(3) ALL ADDENDA SHOULD BE FORMALLY ACKNOWLEDGED BY ALL BIDDERS AND SUBMITTED TO THE STATE PURCHASING DIVISION AND THE STATE AUDITOR'S OFFICE. THE SAME RULES AND REGULATIONS THAT APPLY TO THE ORIGINAL BIDDING DOCUMENT SHALL ALSO APPLY TO AN ADDENDUM DOCUMENT. THE ONLY EXCEPTION MAY BE FOR AN ADDENDUM THAT IS ISSUED FOR THE SOLE PURPOSE OF CHANGING A BID OPENING TIME AND/OR DATE.</p> <p>REV. 11/96</p> <p>EXHIBIT 10</p> <p style="text-align: center;">REQUISITION NO.: DEP13572</p> <p>ADDENDUM ACKNOWLEDGEMENT</p> <p>I HEREBY ACKNOWLEDGE RECEIPT OF THE FOLLOWING CHECKED ADDENDUM(S) AND HAVE MADE THE NECESSARY REVISIONS TO M PROPOSAL, PLANS AND/OR SPECIFICATION, ETC.</p> <p>ADDENDUM NO.'S:</p> <p>NO. 1 <input checked="" type="checkbox"/> NS.</p> <p>NO. 2 .....</p> <p>NO. 3 .....</p> <p>NO. 4 .....</p>						

SEE REVERSE SIDE FOR TERMS AND CONDITIONS

SIGNATURE <i>Nancy S. Somers</i>	TELEPHONE <b>304-745-3652</b>	DATE <b>03-22-07</b>
TITLE <b>OWNER</b>	FEIN <b>33-1135400</b>	ADDRESS CHANGES TO BE NOTED ABOVE

WHEN RESPONDING TO RFQ, INSERT NAME AND ADDRESS IN SPACE ABOVE LABELED 'VENDOR'





State of West Virginia  
 Department of Administration  
 Purchasing Division  
 2019 Washington Street East  
 Post Office Box 50130  
 Charleston, WV 25305-0130

# Request for Quotation

RFQ NUMBER
DEP13572

PAGE
1

ADDRESS CORRESPONDENCE TO ATTENTION OF:
CHUCK BOWMAN
304-558-2157

MIDWEST



Nancy Somers  
 Midway Reclamation  
 P. O. Box 308  
 West Milford, WV 26451  
**501151933**

SHIP TO

ENVIRONMENTAL PROTECTION  
 DEPT. OF  
 OFFICE OF SPECIAL RECLAMATION  
 105 S. RAILROAD STREET  
 PHILIPPI, WV  
 26416-9998      304-457-3219

DATE PRINTED	TERMS OF SALE	SHIP VIA	F.O.B.	FREIGHT TERMS
03/07/2007				
BID OPENING DATE: 03/22/2007		BID OPENING TIME 01:30PM		

LINE	QUANTITY	UQP	CAT NO	ITEM NUMBER	UNIT PRICE	AMOUNT
***** ADDENDUM NO. 1 *****						
ADDENDUM ISSUED FOR THE MOHIGAN MINING COMPANY PROJECT TO DISTRIBUTE THE PRE-BID SIGN-IN SHEET AND TO OFFER CLARIFICATION OF THE SPECIFICATIONS UNDER SECTIONS 4.0 HAULROAD/ACCESS ROAD & 6.0 RIPRAP DITCH WITH LINER. THE REVEISED SPECIFICATIONS AND PRE-BID SIGN-IN SHEET ARE ATTACHED.						
BID DATE REMAINS 03/22/2007 AND BID OPENING TIME REMAINS 1:30 PM.						
***** NO OTHER CHANGES *****						
0001	1	JB		962-73		
RECLAMATION: RESTORATION OF LAND/ WATER						

SEE REVERSE SIDE FOR TERMS AND CONDITIONS

SIGNATURE <i>Nancy S. Somers</i>	TELEPHONE <b>304-745-3652</b>	DATE <b>3-22-07</b>
TITLE <b>OWNER</b>	FEIN <b>33-1135400</b>	ADDRESS CHANGES TO BE NOTED ABOVE

WHEN RESPONDING TO RFQ, INSERT NAME AND ADDRESS IN SPACE ABOVE LABELED 'VENDOR'

RECEIVED

2007 MAR - 7 A 10: 2

PURCHASE DEPARTMENT  
STATE OF WV

002

RECEIVED  
MOHIGAN MINING COMPANY  
DEP 13572

2007 MAR - 6 P 3: 10

ADDENDUM #1

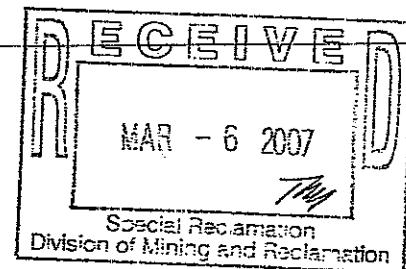

This addendum is provided to clarify the Haulroad/Access Road on bid item #4.0, and clarification for the type of fabric to be used with the Riprap Ditch with Liner bid item #6.0.

#### 4.0 HAULROAD/ACCESS ROAD

The contractor shall maintain and/or construct haulroad/access road(s) during the reclamation process to provide access on a well drained surface. The access road to and on the reclamation site shall be graded, sloped, and maintained to drain to provide a road surface free of excessive mud and standing waters at all times while work is in progress. After any necessary re-shaping and re-grading work on roadways has been performed by the contractor, a six (6) inch layer of #1 limestone (3.5" to 1.5" size) shall be placed on the 4900 feet of road. This stone shall be graded and tracked in with a dozer or other approved equipment to achieve a compacted base for the final top layer of 1 ½ inch crusher run limestone. The No. 1 stone shall then be covered with 1½ inch crusher run limestone so that the surface is choked off and a three (3) inch minimum layer remains on top. Dust-control measures may be necessary if hauling creates airborne material. Snow removal is to be included in this item, if needed. The approximate length of road is 4900 feet. A 24' x 24' truck turn area shall be provided beside CR 47 near the new treatment pond sites. The exact location of the turn area shall be approved by the DEP onsite representative. The truck turn around area shall be incidental to this bid item. No engineering fabric will be utilized on the road.

Any trees or brush within a 30 feet Right-Of-Way (R.O.W.) of the road shall be cleared, and any overhanging limbs within the R.O.W. at a height of 15 feet or less shall be removed. All vegetative cover (trees, shrubs, bushes etc.) within the R.O.W. shall be removed to bare ground. It is the contractor's responsibility to obtain all necessary permits and to follow state guidelines for burning and proper disposal of vegetative materials. Disposal of the trees and shrubs on-site with a chipper is an acceptable alternative to burning.

A roadside vegetated ditch may need to be established/cleaned along this road, and shall be incidental with this bid item. This road upgrade is on the Division Of Highways (DOH) County Route 47 roadway, which requires the use of appropriate flagging and signing as determined by the DOH, and may be found in manual "Temporary Traffic Control for Streets and Highways" March 2006 edition. The contractor shall be responsible for all necessary traffic control measures.

#### 6.0 RIPRAP DITCH WITH LINER

Provide all materials, excavate and construct Ditch as indicated on the attached typical plans, cross-section, specifications, and as discussed at the Pre-Bid Showing. Limestone riprap shall be used. Ditches shall be free draining upon completion of construction. Length of ditch may be adjusted to meet on site conditions. A 30 mil. PVC liner shall be placed on rock free material or a layer of sand shall be placed below liner. A 3 inch layer of limestone sand shall be placed above the liner to act as a cushion for the liner. Engineering fabric shall be placed on top of the sand layer to support the R-4 size limestone riprap. The engineering fabric shall be Mirafi 500X, Typar 3401, or equal.



State of West Virginia  
 Department of Administration  
 Purchasing Division  
 2019 Washington Street East  
 Post Office Box 50130  
 Charleston, WV 25305-0130

# Request for Quotation

RFQ NUMBER  
**DEP13572**

PAGE  
**8**

ADDRESS CORRESPONDENCE TO ATTENTION OF  
**CHUCK BOWMAN**  
**304-558-2157**

SHIP TO

RFQ COPY  
 TYPE NAME/ADDRESS HERE  
**501151933**  
**MIDWAY RECLAMATION, LLC.**  
**P.O. BOX 308**  
**WEST MILFORD, WV 26451**

SHIP TO

**ENVIRONMENTAL PROTECTION**  
**DEPT. OF**  
**OFFICE OF SPECIAL RECLAMATION**  
**105 S. RAILROAD STREET**  
**PHILIPPI, WV**  
**26416-9998 304-457-3219**

DATE PRINTED <b>02/08/2007</b>	TERMS OF SALE	SHIP VIA	FOB	FREIGHT TERMS
BID OPENING DATE: <b>03/22/2007</b>		BID OPENING TIME <b>01:30PM</b>		

LINE	QUANTITY	UOP	CAT NO	ITEM NUMBER	UNIT PRICE	AMOUNT
<p>NO. 5 .....</p> <p>I UNDERSTAND THAT FAILURE TO CONFIRM THE RECEIPT OF THE ADDENDUM(S) MAY BE CAUSE FOR REJECTION OF BIDS.</p> <p><i>Nancy S. Somers</i>            SIGNATURE  <b>MIDWAY RECLAMATION, LLC.</b>            COMPANY            ..... 03-22-2007 .....            DATE</p> <p>REV. 11/96</p> <p>NOTICE</p> <p>A SIGNED BID MUST BE SUBMITTED TO:</p> <p>DEPARTMENT OF ADMINISTRATION            PURCHASING DIVISION            BUILDING 15            2019 WASHINGTON STREET, EAST            CHARLESTON, WV 25305-0130</p> <p>THE BID SHOULD CONTAIN THIS INFORMATION ON THE FACE OF THE ENVELOPE OR THE BID MAY NOT BE CONSIDERED:</p> <p>SEALED BID</p>						

SEE REVERSE SIDE FOR TERMS AND CONDITIONS

SIGNATURE <i>Nancy S. Somers</i>	TELEPHONE <b>304-745-3652</b>	DATE <b>03-22-07</b>
TITLE <b>OWNER</b>	FEIN <b>33-1135400</b>	ADDRESS CHANGES TO BE NOTED ABOVE

WHEN RESPONDING TO RFQ, INSERT NAME AND ADDRESS IN SPACE ABOVE LABELED 'VENDOR'



State of West Virginia  
 Department of Administration  
 Purchasing Division  
 2019 Washington Street East  
 Post Office Box 50130  
 Charleston, WV 25305-0130

# Request for Quotation

RFQ NUMBER  
**DEP13572**

PAGE  
**9**

ADDRESS CORRESPONDENCE TO ATTENTION OF  
**CHUCK BOWMAN**  
**304-558-2157**

S U P P L I E R

RFQ COPY  
 TYPE NAME/ADDRESS HERE  
**501151933**  
**MIDWAY RECLAMATION, LLC.**  
**P.O. BOX 308**  
**WEST MILFORD, WV 26451**

S H I P T O

**ENVIRONMENTAL PROTECTION**  
**DEPT. OF**  
**OFFICE OF SPECIAL RECLAMATION**  
**105 S. RAILROAD STREET**  
**PHILIPPI, WV**  
**26416-9998 304-457-3219**

DATE PRINTED	TERMS OF SALE	SHIP VIA	F.O.B.	FREIGHT TERMS
02/08/2007				

BID OPENING DATE: **03/22/2007** BID OPENING TIME **01:30PM**

LINE	QUANTITY	UOP	CAT NO	ITEM NUMBER	UNIT PRICE	AMOUNT
BUYER:				CB-23		
RFQ. NO.:				DEP13572		
BID OPENING DATE:				03/22/2007		
BID OPENING TIME:				1:30 PM		
PLEASE PROVIDE A FAX NUMBER IN CASE IT IS NECESSARY TO CONTACT YOU REGARDING YOUR BID:						
				304-745-3653		
CONTACT PERSON (PLEASE PRINT CLEARLY): <b>NANCY S. SOMERS</b>						
***** THIS IS THE END OF RFQ DEP13572 ***** TOTAL:						<b>164,876.00</b>

SEE REVERSE SIDE FOR TERMS AND CONDITIONS

SIGNATURE <i>Nancy S. Somers</i>	TELEPHONE <b>304-745-3652</b>	DATE <b>03-22-07</b>
TITLE <b>OWNER</b>	FEIN <b>33-1135400</b>	ADDRESS CHANGES TO BE NOTED ABOVE

WHEN RESPONDING TO RFQ, INSERT NAME AND ADDRESS IN SPACE ABOVE LABELED 'VENDOR'

BUYER CB-23	PAGE 10	REQ OR PO NO DEP 13572
SPENDING UNIT WEST VIRGINIA DEPARTMENT OF ENVIRONMENTAL PROTECTION/SPECIAL RECLAMATION		

WV-36a STATE OF WEST VIRGINIA  
 Rev 1/29/02 PURCHASING CONTINUATION SHEET  
 VENDOR:

**SCOPE OF WORK**

The successful bidder shall provide appropriate equipment, materials, labor and any technical services needed for the successful reclamation of MOHIGAN MINING COMPANY, Permit U-109-83, and any disturbance associated with such operation. The General Performance Standards (GPS) shall apply to all items in Scope of Work.

Work necessary on this site will include the following items, but is not limited to these:

- 1 Upon mobilization to the site, which will be directed in a written Notice to Proceed, the access roads shall be developed in accordance with bid item #4.0. If fuel and lubricants are to be stored on site, bid item #2.0 shall be in place before fuel is delivered. Project sign is to be obtained and installed at the beginning of work.
- 2 Storm water management in the form as described in bid item #3.0 shall be installed (described locations)
- 3 Revegetation and soil improvements are required for areas designated at the Pre-bid Meeting. Reclamation is to be according to the attached specifications, plans, and clarifying discussions at the Pre-Bid Conference.
- 4 Upgrade the haulroad/access road, which is also a county road (CR47)
- 5 Install new culverts on access road, which is also a county road (CR47)
- 6 Construct settling pond
- 7 Construct limestone bed according to plans and specifications
- 8 Construct riprap ditches
- 9 Enhance vegetation with seed, lime, fertilizer, and mulch
- 10 Remove structures and debris from site
- 11 Any other site specific items required

I, David B. McCoy, the undersigned, hereby certify<sup>1</sup> that this Reclamation Plan is correct and shows to the best of my knowledge and belief all the information required by the surface mining laws of the State of West Virginia. The source of information was the approved mining and reclamation plan contained in the forfeited surface mine permit, existing site conditions and information contained in the WV DEP, Inspection and Enforcement files.

*David B. McCoy*

Registered Professional Engineer WV No 14375

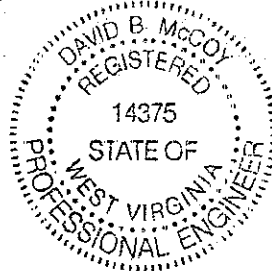

*JBS*  
*1/25/07*

Date: 1-25-07

<sup>1</sup> The term "certify" as used herein is defined as follows: An engineer's certification of conditions is a declaration of professional judgment. It does not constitute a warranty or guarantee, either expressed or implied.

MIDWAY RECLAMATION, LLC.  
P.O. BOX 308  
WEST MILFORD, WV 26451  
501151933

BUYER CB-23	PAGE 111	REQ OR PO NO DEP 13572
SPENDING UNIT WEST VIRGINIA DEPARTMENT OF ENVIRONMENTAL PROTECTION/SPECIAL RECLAMATION		

WV-36a STATE OF WEST VIRGINIA  
Rev. 1/29/02 PURCHASING CONTINUATION SHEET  
VENDOR:

ITEM NO.	QUANTITY	DESCRIPTION	UNIT PRICE	AMOUNT
<b>BID SCHEDULE</b>				
PERMIT NAME: <u>MOHIGAN MINING CO.</u>				
PERMIT NUMBER: <u>U-109-83</u>				
1 0	LUMP SUM	<u>MOBILIZATION/DEMObILIZATION/PROJECT SIGN</u> (5% Total Bid Maximum for this permit)	LUMP SUM	\$ <u>8,000.00</u>
2 0	LUMP SUM	<u>SPILL CONTAINMENT AREA (S.C.A.)</u> (\$1,000.00 Maximum Bid for this permit)	LUMP SUM	\$ <u>1.00</u>
3 0	<u>700</u> LF	<u>HAYBALE DIKE</u> (Max Bid \$5.00 Per LF)	\$ <u>5.00</u> PER LF	\$ <u>3,500.00</u>
4 0	LUMP SUM	<u>HAULROAD/ACCESS ROAD</u>	LUMP SUM	\$ <u>68,000.00</u>
5 0	<u>440</u> LF	<u>CULVERTS</u>	\$ <u>40.00</u> PER LF	\$ <u>17,600.00</u>
6 0	<u>400</u> LF	<u>RIPRAP DITCH WITH LINER</u>	\$ <u>45.00</u> PER LF	\$ <u>18,000.00</u>
7 0	<u>380</u> LF	<u>GROUTED RIPRAP DITCH</u>	\$ <u>40.00</u> PER LF	\$ <u>15,200.00</u>
8 0	LUMP SUM	<u>SEEDLING POND</u>	LUMP SUM	\$ <u>3,000.00</u>
9 0	LUMP SUM	<u>INCLINED LIMESTONE BED</u>	LUMP SUM	\$ <u>17,000.00</u>
10 0	LUMP SUM	<u>6-INCH SCH. 35 PVC PIPING, FITTINGS</u>	LUMP SUM	\$ <u>3,300.00</u>
<b><u>REVEGETATION</u></b>				
11.1	<u>3</u> AC	<u>AGRICULTURAL LIME</u>	\$ <u>450.00</u> PER ACRE	\$ <u>1,350.00</u>
11.2	<u>3</u> AC	<u>FERTILIZER</u>	\$ <u>475.00</u> PER ACRE	\$ <u>1,425.00</u>

MIDWAY RECLAMATION, LLC.  
 P.O. BOX 308  
 WEST MILFORD, WV 26451  
 501151933

BUYER CB-23	PAGE 12	REQ OR PO NO DEP 13572
SPENDING UNIT WEST VIRGINIA DEPARTMENT OF ENVIRONMENTAL PROTECTION/SPECIAL RECLAMATION		

WV-36a STATE OF WEST VIRGINIA  
 Rev. 1/29/02 PURCHASING CONTINUATION SHEET  
 VENDOR:

ITEM NO.	QUANTITY	DESCRIPTION	UNIT PRICE	AMOUNT
11.3	3 AC	<u>MULCH</u>	\$ 500. <sup>00</sup> PER ACRE	\$ 1,500. <sup>00</sup>
11.4	3 AC	<u>VEGETATIVE SPECIES</u>	\$ 500. <sup>00</sup> PER ACRE	\$ 1,500. <sup>00</sup>
12.0	LUMP SUM	<u>STRUCTURE AND/OR DEBRIS REMOVAL</u>	LUMP SUM	\$ 5,500. <sup>00</sup>
		TOTAL PERMIT <u>U-109-83</u>		\$ 164,876. <sup>00</sup>

BUYER CB-23	PAGE 113	REQ OR PO NO DEP 13572
SPENDING UNIT WEST VIRGINIA DEPARTMENT OF ENVIRONMENTAL PROTECTION/SPECIAL RECLAMATION		

WV-36a STATE OF WEST VIRGINIA  
Rev. 1/29/02 PURCHASING CONTINUATION SHEET  
VENDOR:

## BID ITEM TECHNICAL SPECIFICATIONS

### 1 0 MOBILIZATION/DEMobilIZATION/PROJECT SIGN

#### PROJECT SIGN

A project sign shall be obtained or manufactured and installed as indicated on the attached specifications and details. Payment for this sign shall be incidental to the mobilization item. No separate payment will be made.

#### MOBILIZATION

This work shall consist of the performance of construction preparatory operations, including the movement of personnel, equipment and other facilities to the project site necessary to begin work on a substantial phase of the contract.

#### DEMobilIZATION

Prior to demobilization, an inspection shall be conducted by the Department of Environmental Protection and the contractor to insure compliance with contract performance. Once compliance is ascertained, demobilization activities can be initiated and completed. Demobilization shall be totally completed before the invoice for payment shall be processed.

#### PAYMENT

The lump sum bid for this item shall not exceed 5% of the total bid for this permit. Payment shall be made in two 50% amounts, one upon completion of the mobilization and project sign items and the second payment at the completion of demobilization. No deduction shall be made nor shall any increase be made in the lump sum item amount, regardless of decreases or increases in the final total contract amount or any other reason.

### 2 0 SPILL CONTAINMENT AREA (S C A.)

Spill containment measures shall be used for fuel and lubricant storage areas. All containers, barrels, buckets, cans, etc., are to be legally disposed of off site. Used lubricants are to be disposed of according to state law to minimize pollution to the local surface and ground water supplies. Spills are the responsibility of the contractor and need immediate clean up and maintained at no expense to the State. This S.C.A. shall be constructed in accordance with the typical drawing specification (See Attachment). Alternate containment measures will be considered for approval by the Program Manager if acceptable results can be shown. Fuel tanks manufactured with secondary containment are desirable. Minimum secondary containment is 110 percent. (Bid limited to \$1,000.00 maximum)

### 3 0 HAYBALE DIKE

Disturbed areas, which have storm water runoff and does not pass through a sediment control structure, shall utilize the following method to manage storm water runoff: Max Bid of \$5.00/LF of Hay Bale Dike

- 1 All bales shall be placed on the contour
- 2 Bales shall be placed in a row with ends tightly abutting the adjacent bales
- 3 Bales shall be securely anchored in place by stakes or rebars driven through the bales. Rebar to be removed at the direction of DEP. The first stake in each bale shall be driven toward previously laid bale to force the bales together. Construction of sumps may become necessary to supplement the hay bale dikes, which may be directed by the on-site DEP specialist. Any such sumps shall be incidental to this bid item.

### 4 0 HAULROAD/ACCESS ROAD

The contractor shall maintain and/or construct haulroad/access road(s) during the reclamation process to provide access on a well drained surface. The access road to and on the reclamation site shall be graded, sloped, and maintained to drain to provide a road surface free of excessive mud and standing waters at all times while work is in progress. Upon completion of all reclamation activities, a final layer of 1.5 inch crusher run limestone shall be placed on any areas of the roadway affected by the reclamation, or any areas as directed by the on-site DEP.



BUYER CB-23	PAGE 014	REQ OR PO NO DEP 13572
SPENDING UNIT		
WEST VIRGINIA DEPARTMENT OF ENVIRONMENTAL PROTECTION/SPECIAL RECLAMATION		

WV-36a STATE OF WEST VIRGINIA  
Rev. 1/29/02 PURCHASING CONTINUATION SHEET  
VENDOR:

specialist Dust-control measures may be necessary if hauling creates airborne material Snow removal is to be included in this item, if needed The approximate length of road is 4900 feet

Any trees or brush within a 30 feet Right-Of-Way (ROW) of the road shall be cleared, and any overhanging limbs within the ROW at a height of 15 feet or less shall be removed All vegetative cover (trees, shrubs, bushes etc) within the ROW shall be removed to bare ground It is the contractor's responsibility to obtain all necessary permits and to follow state guidelines for burning and proper disposal of vegetative materials Disposal of the trees and shrubs on-site with a chipper is an acceptable alternative to burning

A roadside vegetated ditch may need to be established/cleaned along this road, and shall be incidental with this bid item This road upgrade is on the Division Of Highways (DOH) County Route 47 roadway, which requires the use of appropriate flagging and signing as determined by the DOH, and may be found in manual "Temporary Traffic Control for Streets and Highways" March 2006 edition The contractor shall be responsible for all necessary traffic control measures

#### **50 CULVERTS**

Culvert shall be HDPE, dual wall smooth interior corrugated twenty (20) foot joint type The pipe joints shall be silt-tight and the pipe shall meet ASIM D3350 manufacturing standards Culverts shall be installed according to the Plans and Specifications

Culverts installed in access roads shall cross the road at a 30 degree angle downgrade with a minimum grade of three percent (3%) from inlet to outlet, except in streams or diversion ditches where the pipe shall be installed straight and coincide with the normal direction of flow

Culvert inlet end shall be protected by a headwall of stable non-erodible material and the slope at the outlet shall be protected with an apron of rock riprap, energy dissipater or other designated material The culvert shall be installed in a trench excavated in solid undisturbed ground or formed by compacted earth

The culvert shall be imbedded in a formed trench to a depth no less than 1/10 the outside diameter of the pipe Selected backfill material shall be placed around the culvert in four (4) inch layers and thoroughly compacted by means of hand tamping or manually directed power tampers or plate vibrators

Culvert shall be covered with a minimum of twelve (12) inches or one-half the culvert diameter whichever is greater Culverts shall be eighteen (18) inch inside diameter and installed in forty (40) feet sections at eleven different locations

#### **60 RIPRAP DITCH WITH LINER**

Provide all materials, excavate and construct Ditch as indicated on the attached typical plans, cross-section, specifications, and as discussed at the Pre-Bid Showing Limestone riprap shall be used Ditches shall be free draining upon completion of construction Length of ditch may be adjusted to meet on site conditions A 30 mil. PVC liner shall be placed on rock free material or a layer of sand shall be placed below liner A 3 inch layer of limestone sand shall be placed above the liner to act as a cushion for the liner Engineering fabric shall be placed on top of the sand layer to support the R-4 size limestone riprap

#### **70 GROUTED RIPRAP DITCH**

Provide all materials, excavate and construct Ditch as indicated on the attached typical plans, cross-section, specifications, and as discussed at the Pre-Bid Showing R-4 size limestone riprap shall be used Ditches shall be free draining upon completion of construction Length of ditch may be adjusted to meet on site conditions This ditch starts at the outlet of the inclined limestone bed and ends at a culvert, which crosses under the railroad tracks

The grout filler shall be composed of a mixture of one part Type II (sulfate resistant) portland cement and three parts sand, mixed with water to produce a workable consistency The stone shall be thoroughly wet immediately before grout is applied As soon as the grout is deposited on the surface, it shall be thoroughly worked into the joints The stones shall then be brushed, so that their top surfaces are exposed Grout shall penetrate 100% of the riprap thickness

BUYER CB-23	PAGE 015	REQ OR PG NO DEP 13572
SPENDING UNIT WEST VIRGINIA DEPARTMENT OF ENVIRONMENTAL PROTECTION/SPECIAL RECLAMATION		

WV-36a STATE OF WEST VIRGINIA  
Rev 1/29/02 PURCHASING CONTINUATION SHEET  
VENDOR:

### 8.0 SETTLING POND

One settling pond shall be constructed. The pond shall have a top width of approximately twenty (20) feet, a top length of eighty (80) feet and a total excavation volume of approximately 7,083 cubic feet. The pond shall have a water depth of approximately 6 ft with 2 ft of freeboard. Side slopes shall be one horizontal to one vertical (1h:1v).

The settling pond is a lump sum bid item. The settling pond inlet and outlet spillways shall be paid for under the riprap ditch with liner bid item #60, and shall be trapezoidal in shape instead of a V-ditch. Remove all vegetation during clearing & grubbing operations for the pond site, which is incidental to this bid item.

### EMBANKMENT CONSTRUCTION

Embankments shall be constructed in compacted lifts with no lift exceeding six (6) inches. The entire width of each 6" lift shall be compacted with an overlapping pattern. If necessary, compaction equipment (vibratory roller, sheep's foot roller, etc.) may be used to help secure a solid embankment, which will not slip or allow seepage of the ponded water. The base of any fill areas shall be undercut to solid material, and benched or keyed into the existing bank. All stones exceeding 6 inches shall be removed from the embankment material prior to being placed. Also, any tree limbs and tree roots shall be removed from embankment material prior to compaction. During dry conditions, water may need to be added to the fill material during the placement process to achieve optimum compaction. If the fill material is over saturated with water, the material may need to be spread and aerated prior to placement at the fill site for compaction. The top pond berm width shall be a minimum of 120 feet. During construction if the above mentioned compaction equipment is not utilized, the top berm may need to be wider than 120 feet (20 feet wide) to accommodate multiple dozer passes and overlapping tracking to obtain compaction across the entire top width of pond berm. After appropriate compaction of material is achieved, the embankment slopes may be cut back to a 120 feet top width.

### 9.0 INCLINED LIMESTONE BED

Provide all materials and construct the inclined limestone bed according to the attached typical plans, cross-section, specifications, and as discussed at the Pre-Bid Showing. Inlet, outlet, and baffle heights are critical for proper flow patterns and function of this treatment system. Take all precautions to ensure that the design dimensions are met. The contractor will be responsible for establishing a control point to check for proper building heights during construction of the pond and baffles.

The bed shall have a top width of approximately thirty (30) feet, a top length of one hundred twenty (120) feet and a total excavation volume of approximately 20,581 cubic feet. The bed shall have a maximum water depth of approximately 6.0 ft with a top berm height of 8.5 ft. Side slopes shall be one horizontal to one vertical (1h:1v). Embankments shall be constructed as stated in bid item #8 for "Embankment Construction". The top pond berm width shall be a minimum of 120 feet.

The size of limestone shall be AASHTO #3 (2 1/2 to 1 inches). The limestone bed shall have five baffles constructed of treated lumber and 40 mil HDPE liner material. The inlet channel and trough shall be lined with a 30 mil PVC liner to prevent leakage. This liner shall extend over the inlet skimmer board. See the detail drawings for the limestone bed, inlet skimmer board, outlet skimmer board, and the baffle construction. The limestone bed, skimmer boards, and baffles are a lump sum bid item.

### 10.0 6-INCH SCH. 35 PVC PIPING

Six (6) inch PVC SDR-35 line (gasket joint type) shall be provided. Installation is to be according to the manufacturer's recommendations. Provide all materials, equipment, excavation and personnel necessary for installation of the pipe to transfer water from the existing 6 inch wet seal pipe to the riprap ditch with liner. The pipe must be installed on steep terrain and under an existing road (County Route 47). At the road crossing, the six inch PVC pipe shall be encased with a 12" diameter HDPE conduit pipe with a DR rating of 17 or stronger. Wooden pipe casing skids shall be used around the PVC pipe to prevent damaging the bell of the pipe. The upper end of pipe casing shall be sealed with an expandable spray foam or waterproof sealant to prevent any excess water from entering the casing. The existing roadway shall be open cut to install the pipe, and shall be backfilled with select

BUYER CB-23	PAGE 016	REQ OR PO NO DEP 13572
SPENDING UNIT		
WEST VIRGINIA DEPARTMENT OF ENVIRONMENTAL PROTECTION/SPECIAL RECLAMATION		

WV-36a STATE OF WEST VIRGINIA  
Rev. 1/29/02 PURCHASING CONTINUATION SHEET  
VENDOR:

material placed around the pipe in four (4) inch layers and thoroughly compacted by means of hand tamping or manually directed power tampers or plate vibrators. The pipe shall be buried with a minimum of three (3) feet of cover to avoid freezing. The approximate total length of the acid mine drainage pipe is 250 feet. Molded elbows, coupler fittings, wyes, HDPE casing, and animal guards shall be incidental to this lump sum bid item.

### 11 0 REVEGETATION

The actual seeding date, within the work performance period, shall be at the discretion of the contractor, but a permanent vegetative cover must be established. Verification of materials used shall be required for payment. Seed bed preparation, unless otherwise approved, shall be conducted by industrial disks or tracking with heavy equipment with cleat marks across slope and parallel to the final contours. The surface shall be tracked, track to track. Seeding shall commence after seedbed preparation on a loose and uncompacted soil and with the approval of the Department of Environmental Protection. Contractor shall provide equipment as necessary to secure approval of the seedbed. Revegetation activities shall be carried out in a continuous, concurrent, timely and uniform manner. Failure to do this may result in nonpayment for portions of or the entire Revegetation item. Hydroseeding or broadcast seeding with the approved species is acceptable. The application rate may be increased but the ratio is to remain constant, but no additional monetary compensation will be awarded. Areas outside the limits of construction, disturbed by the contractor, shall be revegetated by the contractor at no expense to DEP. Water utilized for hydroseeding shall be free of injurious or other toxic substances harmful to plant life. The source of water is subject to the approval of the DEP Specialist. It shall be the vendor's responsibility to repeat the procedures under REVEGETATION until a permanent vegetation is established. The acreage quantities in this contract are for bidding purposes only.

A warranty period of one (1) year shall commence upon completion and payment of the revegetation item of the contract. No payment will be made for additional seeding necessary to comply with warranty requirements. The warranty period will be extended for one (1) year from the date of the last augmented seeding done by the contractor. The performance bond and labor and materials bond shall remain in effect throughout the warranty period. The Standards for Evaluating Vegetative Cover as presented in Title 38, CSR2, Section 9 of the West Virginia Surface Mining Reclamation Regulations will apply.

Equipment for the retracking/scarification to eliminate rills and gullies shall be mobilized and utilized to produce slopes consistent with the regrading and topsoiling bid item prior to warranty reseeding. No additional payment will be made by DEP for this warranty work.

### 11.1 AGRICULTURAL LIME

Unless otherwise specified, all lime used shall be registered with the West Virginia Department of Agriculture, have an 85% minimum calcium carbonate equivalent, and meet the fineness classification no larger than that for ground lime.

Use of blends and low-grade agricultural liming materials shall require prior approval. Lime shall be spread as soon as possible after delivery to site. Lime shall be applied evenly and uniformly distributed over the treated area. Lime shall be thoroughly mixed into the soil material. Lime subjected to adverse conditions before spreading will be deemed unacceptable. Failure to complete this phase shall result in nonpayment of this bid item.

Lime Applied at 10 ton/acre

### 11 2 FERTILIZER

Fertilizer rates given for REVEGETATION are for 1,000 lbs of 10-20-20 per acre. These rates are minimum and for bidding purposes.

Fertilizer shall be applied evenly and uniformly distributed over the treated area. Common complete fertilizers which meet the minimum standards are acceptable.

BUYER CB-23	PAGE 017	REQ OR PO NO DEP 13572
SPENDING UNIT		
WEST VIRGINIA DEPARTMENT OF ENVIRONMENTAL PROTECTION/SPECIAL RECLAMATION		

WV-36a STATE OF WEST VIRGINIA  
 Rev. 1/29/02 PURCHASING CONTINUATION SHEET  
 VENDOR:

**11 3 MULCH**

Acceptable mulch for this project is wood fiber, hay, or straw  
 Mulch: Wood Fiber @ 10 ton/Acre  
 Hay or straw mulch may be substituted at a rate of 2 tons/Acre

**11 4 VEGETATIVE SPECIES**

Seeding rate required is for pure live seed (pls) in pounds per acre The use of annuals or cover crops will not be considered for vegetative success

NOR IH MIX

<u>VEGETATIVE SPECIES</u> <sup>1</sup>	<u>RATE/ACRE</u> <sup>1</sup>
Orchard Grass	@ 15 lbs/acre
Birdsfoot Trefoil <sup>2</sup>	@ 15 lbs/acre
Yellow Sweet Clover	@ 5 lbs/acre
Red Clover	@ 10 lbs/acre
Ky 31 Fescue	@ 15 lbs/acre
Foxtail Millet <sup>3</sup>	@ 12 lbs/acre
Wheat or Rye <sup>4</sup>	@ 50 lbs/acre
Black Locust <sup>5</sup>	@ 3 lbs/acre

- 1 Seeding rate suggested is for pure live seed (pls) in pounds per acre
- 2 Herbaceous legumes must be treated with the appropriate bacterium before seeding
- 3 Spring mix
- 4 Fall mix
- 5 Black locust used only for woodland land use

**12 0 STRUCTURE AND/OR DEBRIS REMOVAL**

All existing man-made items particular to the site and not to be utilized in the total reclamation of this site shall be demolished (if necessary) and disposed of in a legal manner All iron, steel, aluminum, or any other metal, plastic, or any other man made material, including but not limited to I-Beams, Angle Iron, Channel Iron, Corrugated Metal, Flat Metal, Floc Drums, Grease Drums, Pipe or Conduit is to be dismantled, removed and properly disposed of off site and according to state, local, and federal requirements

BUYER CB-23	PAGE 018	REQ OR PO NO DEP 13572
SPENDING UNIT WEST VIRGINIA DEPARTMENT OF ENVIRONMENTAL PROTECTION/SPECIAL RECLAMATION		

WV-36a STATE OF WEST VIRGINIA  
 Rev. 1/29/02 PURCHASING CONTINUATION SHEET  
 VENDOR:

**BID PREPARATION INFORMATION**

**HISTORICAL INFORMATION**

Prospective bidders may review files at the West Virginia Department of Environmental Protection, Charleston, WV office, or the Regional West Virginia Department of Environmental Protection Office at 105 South Railroad St, Philippi, WV 26416. These files may contain additional information not included in the contract Documents including, but not limited to, permit applications, permits, inspection reports, environmental documents, permit violation history, geological and geotechnical information, probable hydrologic consequences, maps, modifications, NPDES information and other related data. Copies may be obtained upon request and payment of copying fees.

**EXAMINATION OF BID PACKAGE AND SITE OF WORK**

The bidder is required to examine, carefully, the bid package (plans, specifications, supplemental specifications, contract forms, etc.) and the site of the work contemplated. The submission of a bid shall be considered prima facie evidence that the bidder has made such examination and has judged for and satisfied themselves as to the character, quantity, and quality of work to be performed and the materials required to be furnished under the contract.

**PREBID CONFERENCE**

Only the prospective bidders on the sign-in sheet in attendance for the entire Pre-Bid Conference will be eligible to submit bids for consideration of this project.

**VIDEO**

The information given at the pre-bid showing by the project contact person or the assigned person shall be documented on video tape and shall be an integral part of this contract's requirements, but will not supersede the written contract.

**INTENT OF CONTRACT**

The intent of the contract is for the reclamation/restoration of forfeited mine lands as required by West Virginia Department of Environmental Protection. The contractor is to provide for the construction and completion in every detail of the work described. The Contractor shall furnish all labor, materials, equipment, tools, transportation, and supplies required to complete the work in accordance with the Plans, Specifications, and terms of the Contract.

Should any misunderstanding arise as to the intent or meaning of the Contract, or any discrepancy appear, the decision of the Director of Division of Land and Restoration shall be final.

BUYER CB-23	PAGE 019	REQ OR PO NO DEP 13572
SPENDING UNIT WEST VIRGINIA DEPARTMENT OF ENVIRONMENTAL PROTECTION/SPECIAL RECLAMATION		

WV-36a                                      STATE OF WEST VIRGINIA  
Rev. 1/29/02                      PURCHASING CONTINUATION SHEET  
VENDOR:

## GENERAL PERFORMANCE STANDARDS

### INTRODUCTION

The performance standards and non-compliance penalties which govern special reclamation-bond forfeiture projects are in Chapter 22A, Article 3, of the Code of West Virginia and subsequent rules and regulations. The following performance standards are of a general nature and do not represent all the performance standards applicable to a special reclamation-bond forfeiture project. However, some or all of these standards will pertain to each project.

### BACKFILLING

- 1 Unless otherwise noted, the highwall shall be eliminated and the disturbed area graded to the approximate original contour.
- 2 The material used to backfill and eliminate the highwall shall be sufficiently compacted so as to insure stability of the backfill throughout the warranty period.
- 3 The land above the highwall shall not be disturbed unless otherwise directed.
- 4 The best available material to support vegetation, sufficient to establish a permanent vegetative cover and to achieve the approved post mining land use, shall be used.

### BLASTING

The performance standards of the blasting regulations must be adhered to.

### LIFE OF CONTRACT

The purchase order contract becomes effective on the starting date as specified in the notice to proceed as issued by the Department of Environmental Protection. This contract extends for a period of one (1) year and may be renewed until such "reasonable time" thereafter as is necessary to complete the payment therefor. A responsible Contractor's Agent shall be on the site at all working times who demonstrates a knowledge of mined land reclamation, contract requirements and responds to DEP (owner) inspections.

### WORK PERFORMANCE PERIOD

The work performance period is a defined portion of the contract in which all items shall be completed. The work performance period is to be performed within 365 calendar days. Extensions may be granted based upon contractor's performance, weather conditions and site-specific site conditions.

### NOTICE TO PROCEED

A notice to proceed shall be issued to the Contractor by the project contact person for the Department of Environmental Protection. Actual construction may only begin after a Notice to Proceed is given and as specified. Such notice shall specify the starting date of the Purchase Order, the work performance period, and the completion date of the work performance period.

### PRE-CONSTRUCTION CONFERENCE

The Contractor in possession of the awarded purchase order shall schedule a Pre-Construction Conference on the site within ten (10) days after receiving the Notice To Proceed. The Contractor's foreman or the on-the-ground supervisor must be in attendance.

BUYER CB-23	PAGE 020	REQ OR PO NO DEP 13572
SPENDING UNIT WEST VIRGINIA DEPARTMENT OF ENVIRONMENTAL PROTECTION/SPECIAL RECLAMATION		

WV-36a STATE OF WEST VIRGINIA  
Rev 1/29/02 PURCHASING CONTINUATION SHEET  
VENDOR:

**GENERAL SUPERVISION** - This contract is under the general supervision of the West Virginia Department of Environmental Protection's contact person for the purpose of contract compliance inspection only Contractor shall supervise work being conducted at all times All services rendered by the Engineer/Contact Person consist of professional opinions and recommendations made in accordance with generally accepted engineering practice Under no circumstances is it the intent of the Engineer/Contact Person to directly control the physical activities of the Contractor or the Contractor's workmen's accomplishment of work on this project

**CONTRACTOR RESPONSIBILITY**

The contractor is responsible for compliance with all aspects of this written contract No changes will be honored without prior approval from the Program Supervisor.

**SILENCE OF SPECIFICATIONS**

The apparent silence of these Specifications, Supplemental Specifications, plans and Special Provisions as to any detail, or the apparent omission from them of a detailed description concerning any point shall be regarded as meaning that only material and workmanship of acceptable quality are to be used

**LAWS TO BE OBSERVED**

The Contractor shall keep fully informed of all Federal and State laws, all local laws, ordinances, and regulations and all orders and decrees of bodies or tribunals having any jurisdiction or authority, which in any manner affect those engaged or employed on the work, or which in any way affect the conduct of the work The Contractor shall at all times observe and comply with all such laws, ordinances, regulations, orders and decrees; and shall protect and indemnify the State and its representatives against any claim or liability arising from or based on the violation of any such laws, ordinances, regulations, orders, or decrees, whether by themselves, their subcontractors or their employees

**PERMITS, LICENSES AND TAXES**

The Contractor shall procure all permits and licenses, pay all charges, fees, and taxes, and give all notices necessary and incidental to the due and lawful prosecution of the work

**CONCURRENT RECLAMATION**

Reclamation of this project shall commence at a definite point as defined and shall progress from that point with total reclamation to include backfilling, grading/regrading, and revegetation Changes may be granted based upon weather or differing site conditions with prior approval

BUYER CB-23	PAGE 021	REQ OR PO NO DEP 13572
SPENDING UNIT WEST VIRGINIA DEPARTMENT OF ENVIRONMENTAL PROTECTION/SPECIAL RECLAMATION		

WV-36a STATE OF WEST VIRGINIA  
 Rev 1/29/02 PURCHASING CONTINUATION SHEET  
 VENDOR:

**WATER QUALITY CONTROL**

Shall commence with initial start-up of the project and remain in effect for the extent of the backfilling, regrading and revegetation activity DEP obtains a storm water permit for each project from the Water Resources Division (General Water Pollution Control Permit WVO115924) The Contractor is responsible for performing the best management practices Adequate facilities shall be installed, operated and maintained using the best management practices of the US Environmental Protection Agency's Non-Point Source (NPS) Program for sediment control during the active reclamation The contractor shall take any and all steps necessary to prevent erosion or silting problems from occurring and to minimize pollution or sedimentation of the stream If any such problems develop, the contractor shall be responsible to take immediate corrective action No separate payment for this work will be honored All impounded waters which require removal during reclamation, shall be pumped with appropriate measures taken to prevent erosion from the discharge The contractor shall be responsible for treatment of said waters to meet pH standards The water shall be discharged only when the quality meets a pH equivalent to the pH of the receiving stream but not less than 6.0

**DIFFERING SITE CONDITIONS**

During the progress of the work, if subsurface or latent physical conditions are encountered at the site differing materially from those indicated in the contract or if unknown physical conditions of an unusual nature, differing materially from those ordinarily encountered and generally recognized as inherent in the work provided by the contract, are encountered at the site, the party discovering such conditions shall promptly notify the other party in writing of the specific differing conditions before they are disturbed and before the affected work is performed

Upon written notification, the Engineer/Contact Person will investigate the conditions, and if determined that the conditions materially differ and cause an increase or decrease in the cost or time required for the performance of any work under the contract, an adjustment, excluding loss of anticipated profits, will be made and the contract modified in writing accordingly The Engineer/Contact Person will notify the Contractor of DEP's determination whether or not an adjustment of the contract is warranted

No contract adjustment which results in a benefit to the Contractor will be allowed unless the Contractor has provided the required written notice

No contract adjustment will be allowed under this clause for any effects caused on unchanged work

**HANDLING AND STORAGE OF MATERIALS**

Materials which are stored on site, before utilization, shall be stored so as to assure the preservation of their quality and fitness for the work Stored materials, even though approved before storage, may be inspected again prior to their use in the work Damaged or deteriorated materials shall be removed and replaced by materials meeting the original specifications

Aggregate stockpiles shall be made on ground that is denuded of vegetation, hard, and well drained Removal of aggregate from the stockpile shall be done in a manner which will not result in the inclusion of foreign material into the aggregate The use of the aggregate will determine if exceptions are permitted

All materials shall be handled in such a manner as to preserve their quality and fitness for the work

**MAINTENANCE DURING CONSTRUCTION**

The contractor shall maintain the work during construction and until the project is accepted All cost of maintenance work during construction and before the project is accepted shall be included in the unit or lump sum prices on the various pay items



BUYER CB-23	PAGE 122	REQ OR PO NO DEP 13572
SPENDING UNIT WEST VIRGINIA DEPARTMENT OF ENVIRONMENTAL PROTECTION/SPECIAL RECLAMATION		

WV-36a STATE OF WEST VIRGINIA  
Rev 1/29/02 PURCHASING CONTINUATION SHEET  
VENDOR:

**FINAL INSPECTION**

A final inspection meeting by the Department of Environmental Protection's Specialist and the contractor is required for the construction phase and prior to demobilization

**ACREAGE QUANTITIES**

The acreage quantities in this contract are for bidding purpose and are set (definite) number for the project area as specified at the pre-bid showing. Only surveyed acreage's through figures the Contractor and/or the State develops will be honored to alter these acreage numbers

**PAYMENT**

Invoices must be submitted on prescribed Department of Environmental Protection, Special Reclamation Program forms and include verification, Certified contractor payrolls for operators directly involved in this project and a current workers compensation certificate must accompany each invoice for payment. Verification of wage rates may include employee interviews. Invoices shall be signed in blue ink so that it is easy to verify that document is an original.

MOBILIZATION/DEMOLIBILIZATION shall be invoiced at fifty percent (50%) with the first invoice and the last 50% invoiced after demobilization and acceptance of the road abandonment or final invoice. Demobilization must have written approval.

SPILL CONTAINMENT AREA shall not exceed \$1,000.00 and will be payable in two payments. The first fifty percent (50%) payable with the first invoice and the remainder payable when all fuel tanks, containers and etc., are removed from the site.

Lump sum items shall be percentage payments based on work completed at time of invoice and paid upon acceptance by the Department of Environmental Protection.

Unit items shall be invoiced by specified units completed and accepted by the DEP.

ROAD ABANDONMENT shall be included in the final construction invoice.

**FAILURE TO COMPLETE ON TIME AND LIQUIDATED DAMAGES**

Time is an essential element of the Contract and it is important that the work be completed within the time specified. The cost to the Department of the administration of the Contract, including engineering, inspection and supervision, will increase as the time required to complete the work is increased.

The work performance period as specified in the contract's Notice to Proceed shall be complied with or result in liquidated damages. Such damages shall be assessed at an amount of two hundred and fifty dollars (\$250.00) per day for each and every day beyond the work performance period as specified in the Notice to Proceed. The total amount of daily charges will be deducted from any moneys due the Contractor, not as a penalty but as liquidated damages.

BUYER CB-23	PAGE 023	REQ OR PO NO DEP 13572
SPENDING UNIT		
WEST VIRGINIA DEPARTMENT OF ENVIRONMENTAL PROTECTION/SPECIAL RECLAMATION		

WV-36a STATE OF WEST VIRGINIA  
Rev 1/29/02 PURCHASING CONTINUATION SHEET  
VENDOR:

**REVEGETATION AND WARRANTY**

The seeding date shall be at the discretion of the contractor once an approved seedbed has been prepared. In all cases a permanent vegetative cover capable of supporting the post-mining land use must be established. A warranty period of one (1) year shall commence upon completion and payment of the revegetation item of the contract. No payment will be made for additional seeding necessary to comply with warranty requirements. The warranty period will be extended for one (1) year from the date of the last augmented seeding done by the contractor. The performance bond and labor and materials bond shall remain in effect throughout the warranty period. The Standards for Evaluating Vegetative Cover as presented in Title 38, CSR2, Section 9 of the West Virginia Surface Mining Reclamation Regulations will apply.

Equipment for the retracking/scarification to eliminate rills and gullies shall be mobilized and utilized to produce slopes consistent with the regrading and topsoiling bid item prior to warranty reseeding. No additional payment will be made by DEP for this warranty work.

Water utilized for hydroseeding shall be free of injurious or other toxic substances harmful to plant life. The source of water is subject to the approval of the DEP contact person.

**CONTRACT NON-COMPLIANCE**

If in the opinion of the Department of Environmental Protection the contract is not in compliance with any line item specification, that portion of the project shall cease until a compliance schedule and understanding is demonstrated in writing and accepted by the Director of Division of Land Restoration.

**CONTRACT DELETIONS**

Any line item, or any portion thereof, may be deleted when determined by the project contact person that such line item, or portion thereof, is deemed unnecessary for the successful reclamation of this project. No claim for loss of anticipated profits will be considered.

**CANCELLATION**

The performance of work under contract may be terminated by the State in whole, or from time to time in part whenever the State shall determine that such termination is in the best interest of the State. Any such termination shall be effected by delivery to the Contractor of a Notice of Termination specifying the extent to which performance of work under the Contract is terminated and the date upon which such termination becomes effective.

When contracts, or any portion thereof, are terminated before completion of all items of work in the Contract, payment will be made for the actual number of units or items of work completed and accepted at the contract unit price. No claim for loss of anticipated profits will be considered. Reimbursement for organization of the work, when not otherwise included in the Contract, and moving equipment to and from the job will be considered where the volume of work completed and accepted is too small to compensate the Contractor for these expenses under the contract unit prices, the intent being that an equitable settlement will be made with the Contractor.

Termination of the Contract or a portion thereof shall not relieve the Contractor of his responsibilities for the completed work, nor shall it relieve his surety of its obligation for and concerning any just claims arising out of the work performed.

This contract may be cancelled in whole or in part in writing by the Director of Purchasing, without prejudice to any other right or remedy it may have, provided that the contractor is given not less than thirty (30) calendar days written notice, (delivered by certified mail, return receipt requested) of intent to terminate. This contract objective is to comply with the reclamation laws of this state and must be expedient to meet the time requirements for reclamation of revoked surface mine permits.

BUYER CB-23	PAGE 020	REQ OR PO NO DEP 13572
SPENDING UNIT WEST VIRGINIA DEPARTMENT OF ENVIRONMENTAL PROTECTION/SPECIAL RECLAMATION		

WV-36a STATE OF WEST VIRGINIA  
 Rev. 1/29/02 PURCHASING CONTINUATION SHEET  
 VENDOR:

S

Attn:

A

Re: Notice to Proceed  
 Permit Name: \_\_\_\_\_  
 Permit No \_\_\_\_\_  
 Purchase Order No : DEP

Dear :

The purpose of this letter is to express our appreciation for your work in advance and to recognize a reclamation partnership project. The official starting date for the above mentioned purchase order is \_\_\_\_\_. The work performance period must be completed by \_\_\_\_\_. The contract life of one year is provided to accomplish all line items and to process all payments within that period.

You must schedule a pre-construction conference on site within ten (10) days after receiving this notice to proceed. It is then mandatory that construction begins within ten (10) days of the pre-construction conference and continues diligently until completion of the project. Please contact this office to schedule the pre-construction conference. The foreman, superintendent, or on-the-ground supervisor must be in attendance at this conference.

Failure to comply with this notice to proceed will cause termination of the contract and forfeiture of your performance bond.

If you have any questions please feel free to contact this office.

A

Sincerely,

E

BUYER CB-23	PAGE 025	REQ OR PO NO DEP 13572
SPENDING UNIT WEST VIRGINIA DEPARTMENT OF ENVIRONMENTAL PROTECTION/SPECIAL RECLAMATION		

WV-36a STATE OF WEST VIRGINIA  
Rev 1/29/02 PURCHASING CONTINUATION SHEET  
VENDOR:

---

## General Requirements

### Project Construction Sign

#### Work Required

The work to be performed under this Section consists of providing all labor, material and equipment necessary to install a project sign as indicated on the detail included herein and as specified herein

#### Materials

- (a) Paint. Paint for the project sign shall be one (1) coat Exterior-Grade Wood Primer- Sealer, and two (2) coats Exterior-Grade Enamel by Glidden or equivalent
- (b) Wood. Sign face shall be 3/4" X 4' X 8' Marine Exterior plywood, and posts and cross braces shall be treated
- (c) Hardware. All hardware shall be manufactured from good, commercial-quality material and be rust resistant such as galvanized coated

#### Execution

- (a) Project Sign. The signboard shall be cut to the dimensions shown on the details herein. The sign shall be painted with one (1) coat of primer and two (2) coats of white enamel. All exterior cut edges shall be smooth sanded prior to painting. All edges shall be double primed. The letters, border and strips shall be painted as shown on the detail drawing.

The Contractor shall bolt the sign to posts and provide required cross bracing. The posts and sign shall be erected and posts set in gravel base, as shown on the drawings. One (1) sign is required and is to be located at the direction of WVDEP.

- (b) Payment. Payment for the work which shall include installation of the project sign shall be incidental to the lump sum bid item for "Mobilization/Demobilization"

Note: No construction work shall commence prior to the project sign being installed



STATE OF WEST VIRGINIA  
DEPARTMENT OF ENVIRONMENTAL PROTECTION

Division of Land Restoration  
Office of Special Reclamation

Joe Manchin, III  
Governor



Stephanie Timmermeyer,  
Cabinet Secretary



Ken Ellison,  
Director

Project Cost: \$XXX,XXX.00  
Funding provided by the Special Reclamation Coal Tax paid by WV Coal Mine Companies

Permit Name  
Permit Number

Contractor: Joe Smith Contracting

Project Start Date: 01/01/01

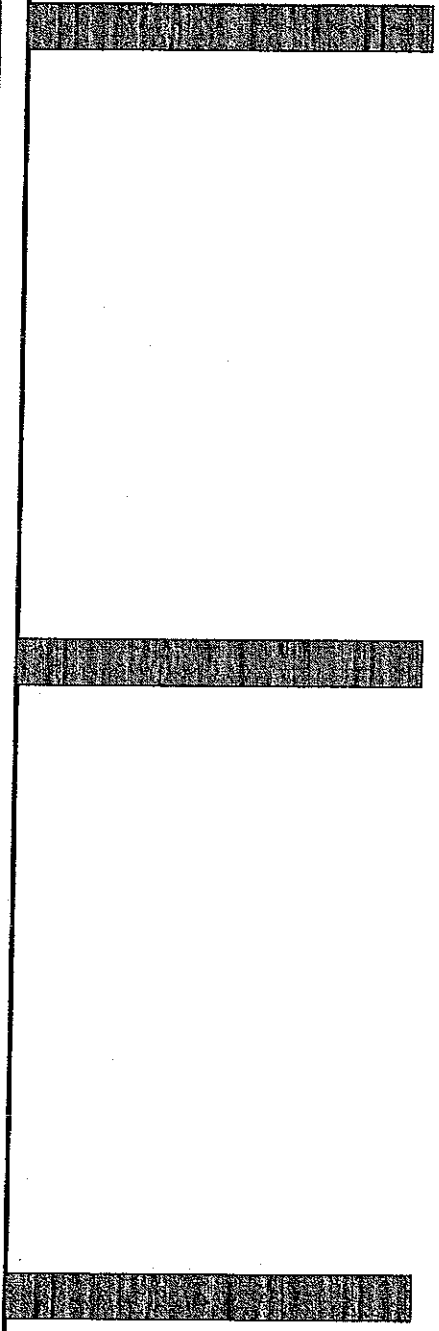

77 1/4"

27 3/4"

17 1/4"

1 1/2"

1 1/8"



15 3/4"

**STATE OF WEST VIRGINIA**  
**DEPARTMENT OF ENVIRONMENTAL PROTECTION**

**Division of Land Restoration**  
**Office of Special Reclamation**

**Joe Manchin, III**  
 Governor



Project Cost: \$XXX,XXX.00  
 Funding provided by the Special Reclamation Coal Tax paid by WV Coal Mine Companies

Stephanie Timmermeyer,  
 Cabinet Secretary



Ken Ellison,  
 Director

Permit Name  
 Permit Number

Contractor: Joe Smith Contracting

Project Start Date: 01/01/01

18"

2 1/4"

73 7/8"

36"

36"

48"

6"

6"

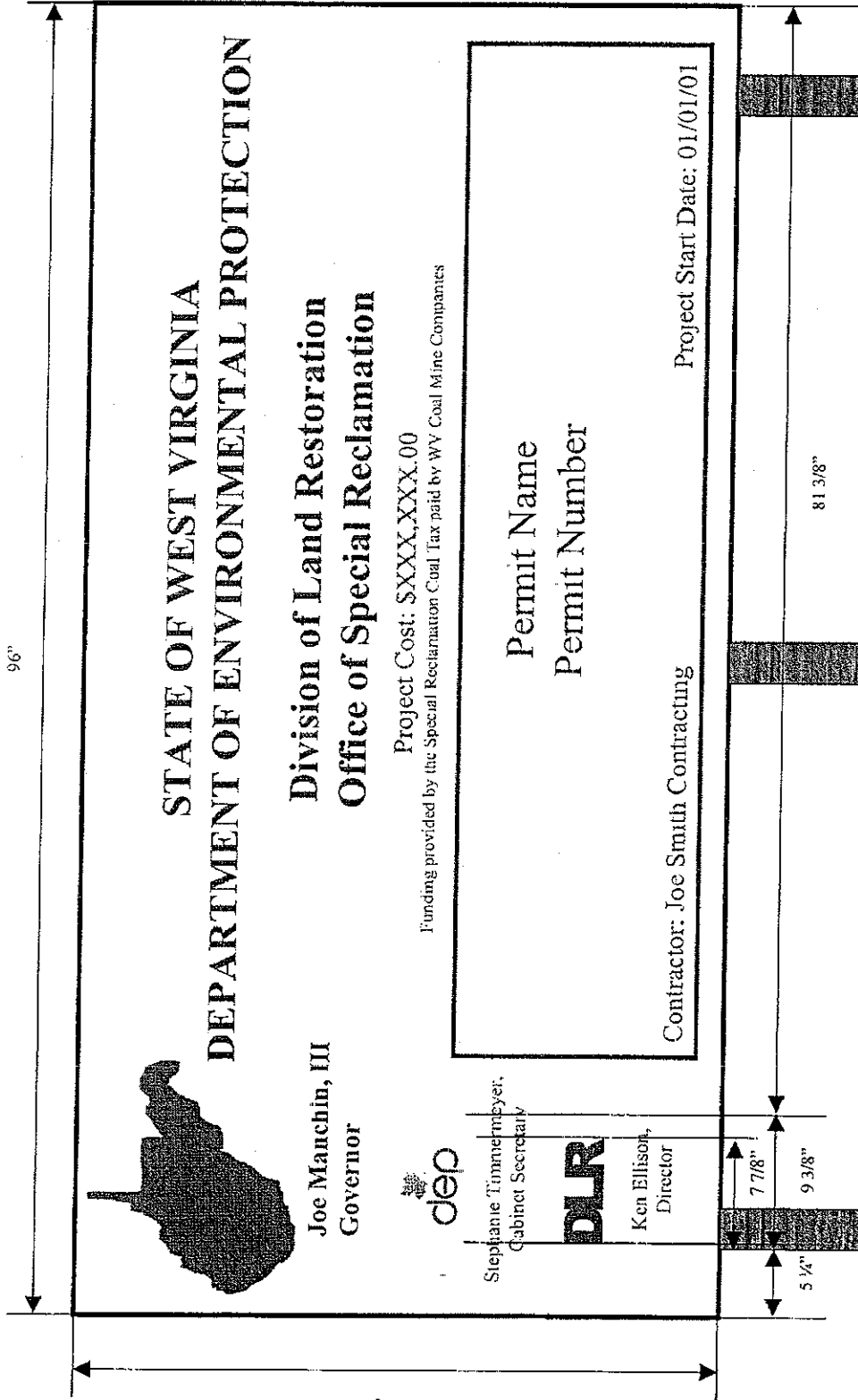

96"

48"

STATE OF WEST VIRGINIA  
DEPARTMENT OF ENVIRONMENTAL PROTECTION

Division of Land Restoration  
Office of Special Reclamation

Project Cost: SXXX,XXX.00  
Funding provided by the Special Reclamation Coal Tax paid by WV Coal Mine Companies

Permit Name  
Permit Number

Contractor: Joe Smuth Contracting  
Project Start Date: 01/01/01



Joe Mauchin, III  
Governor



Stephanie Timmermeyer,  
Cabinet Secretary



Ken Ellison,  
Director

7 7/8"

9 3/8"

5 1/4"

81 3/8"

17 1/2" 6" 2 1/4" 1 1/2" 2 1/4" 3 1/4" 2 1/4" 1 1/2" 2 1/4" 3 1/4" 1 1/2" 4 7/8" 2 1/4" 1 1/2" 2 1/4" 4 7/8" 1 1/4" 3 1/4"

STATE OF WEST VIRGINIA  
DEPARTMENT OF ENVIRONMENTAL PROTECTION

Division of Land Restoration  
Office of Special Reclamation

Project Cost: \$XXX,XXX.00  
Funding provided by the Special Reclamation Coal Tax paid by WY Coal Mine Companies

Permit Name  
Permit Number

Contractor: Joe Smith Contracting  
Project Start Date: 01/01/01



Joe Manchin, III  
Governor



Stephanie Zimmerman  
Cabinet Secretary

DLR

Ken Ellison  
Director

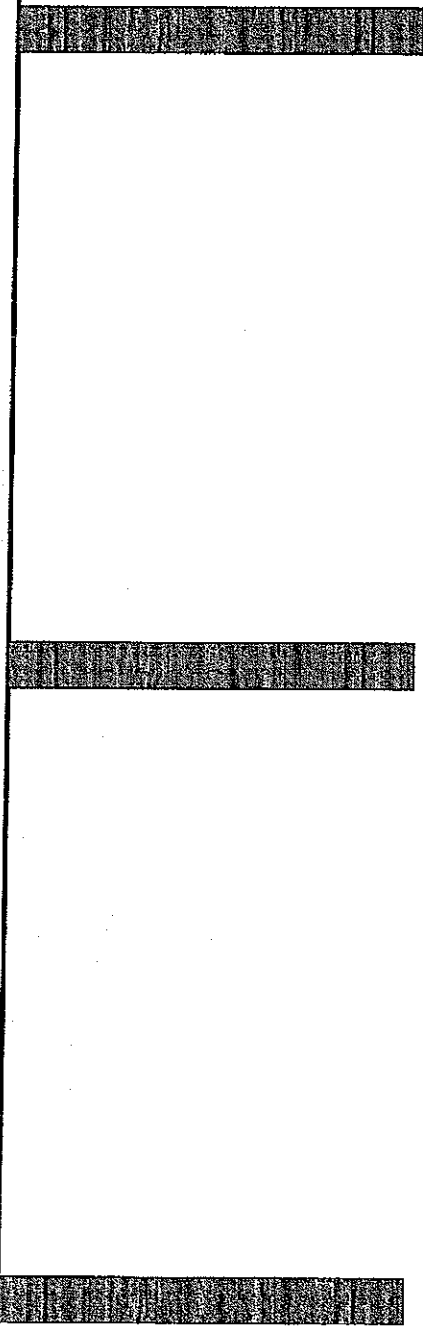



- NOTES:**
- 1.) SIGN BOARD TO BE 3/4" x 4' x 8' MARINE PLYWOOD.
  - 2.) SIGN BOARD COLOR IS WHITE AND LETTER COLORS ARE DARK GREEN.
  - 3.) TREATED 2" x 4" CROSS BRACE LET INTO POSTS.
  - 4.) MOUNT SIGN TO POSTS USING 3/8" x 5" GALVANIZED CARRIAGE BOLTS.
  - 5.) USE 4" x 4" x 12' TREATED POSTS.
  - 6.) LOCATION DETERMINED BY WVDOT.

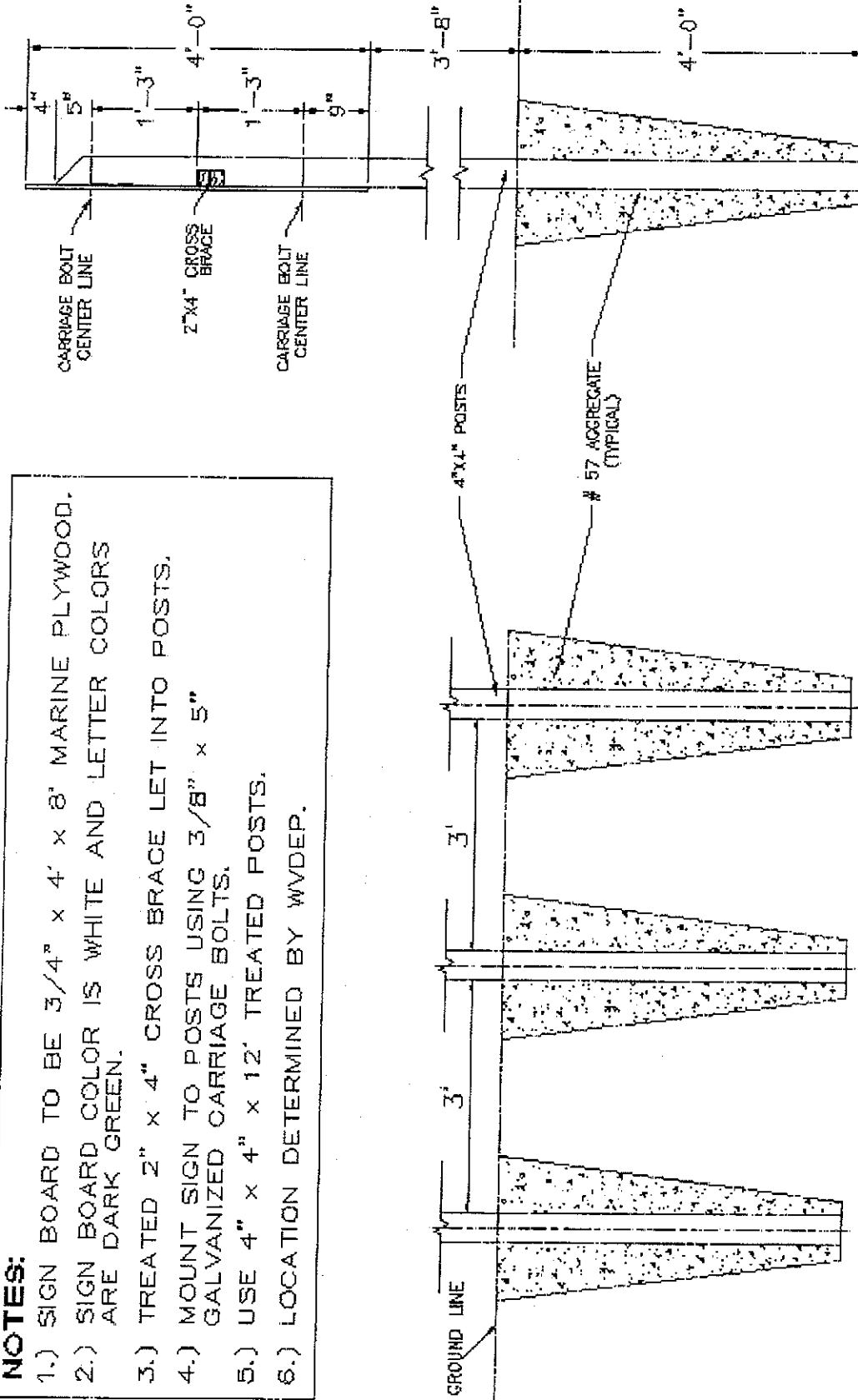

PROJECT SIGN  
NOT TO SCALE

**MOHIGAN  
MINING CO.  
PERMIT U-109-83**

CB-23

PAGE **031** DEP 13572

**LOCATION MAP**

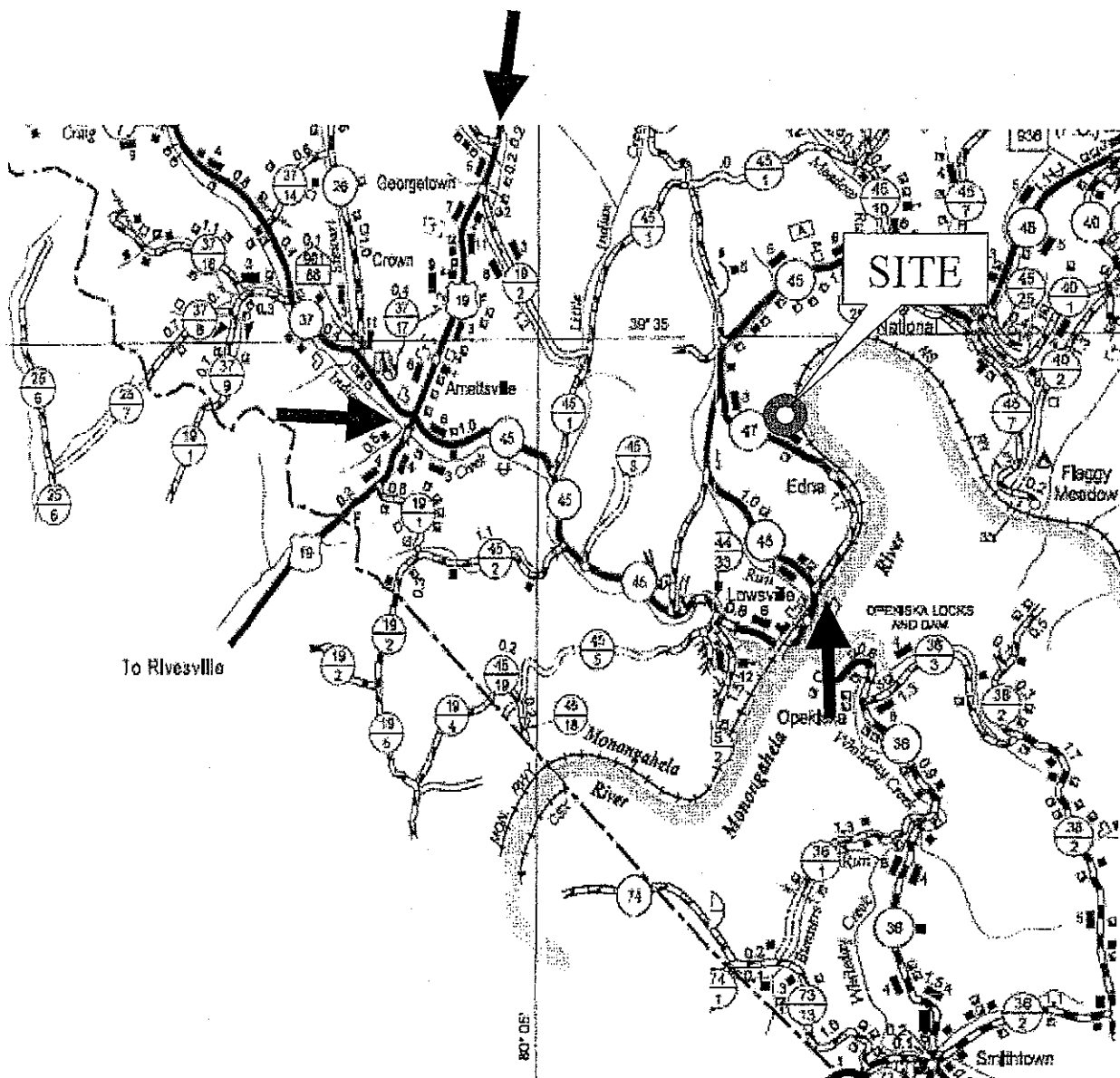

At the Westover exit of Interstate I-79 in Monongalia County, turn South on US Route 19 and go 8.3 miles. Turn left on County Route 45 and go 3.3 miles to the access road on the right.

PERMIT U-109-83

BUYER PAGE REQ. or PD No  
CB-23 032 DEP 13572

DESIGN CONDITIONS

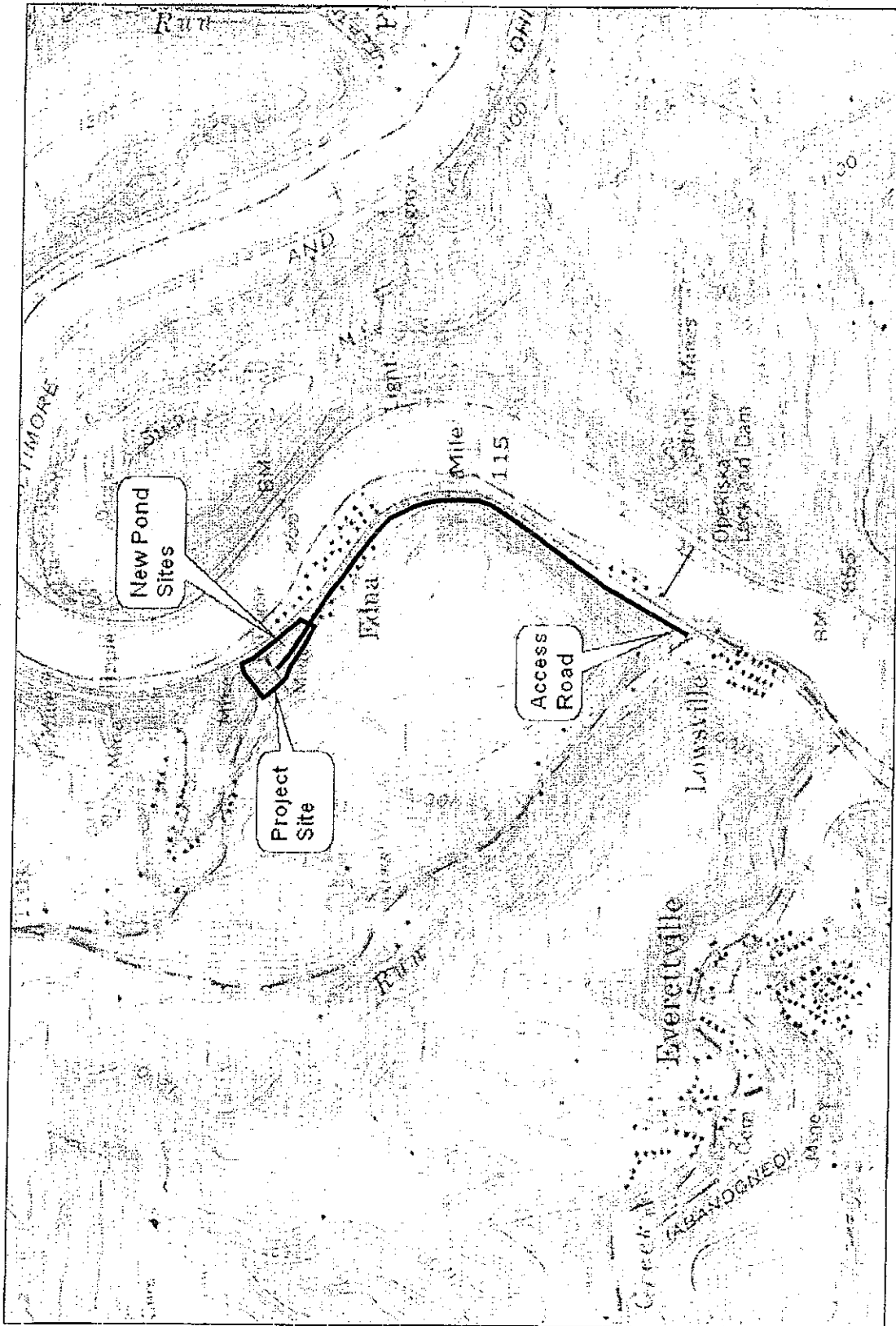

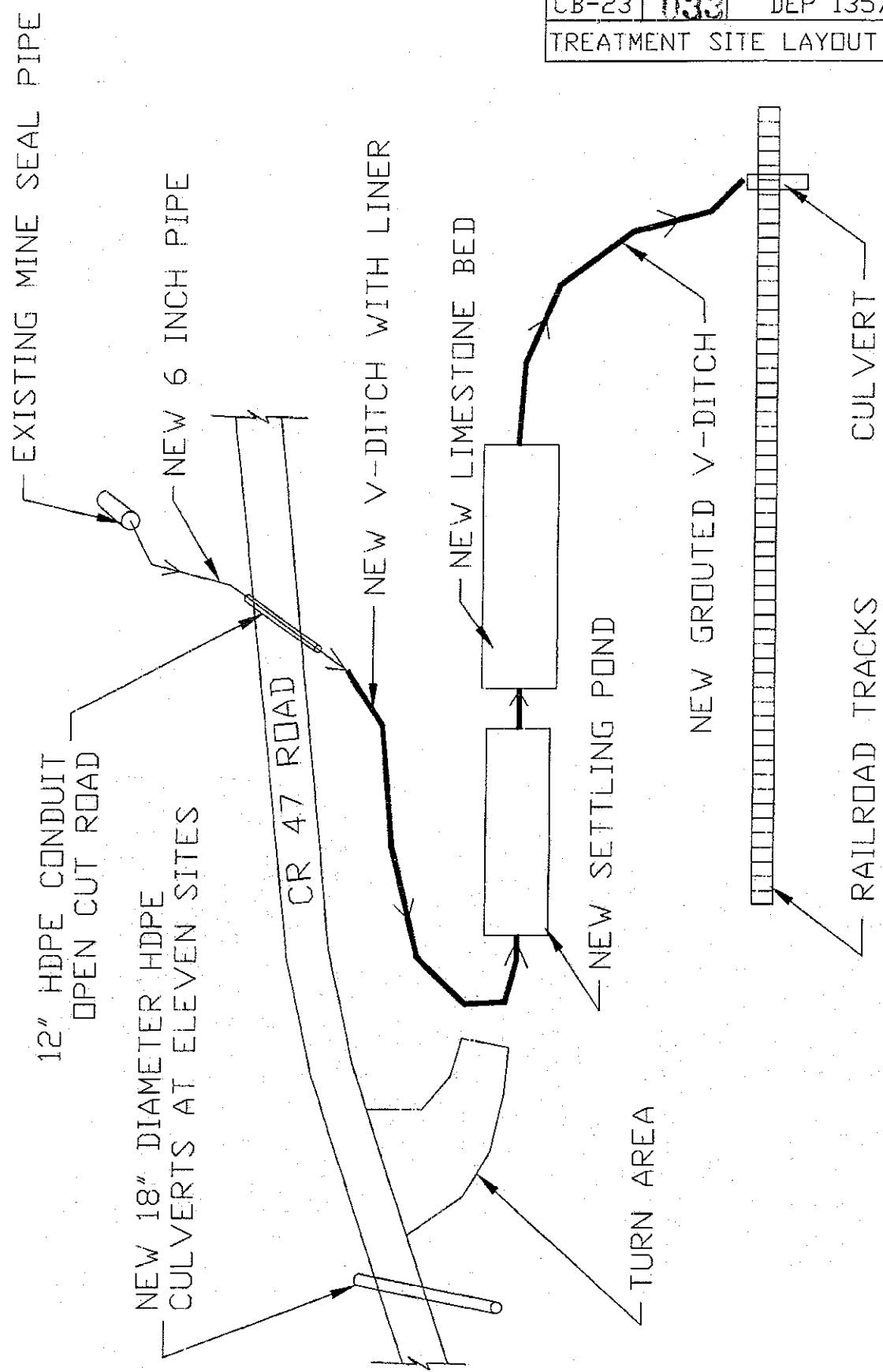

SETTLING POND

SETTLING POND

PLAN VIEW

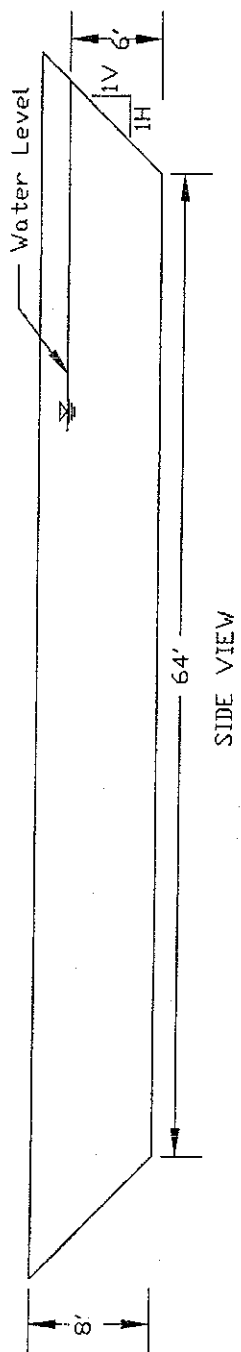
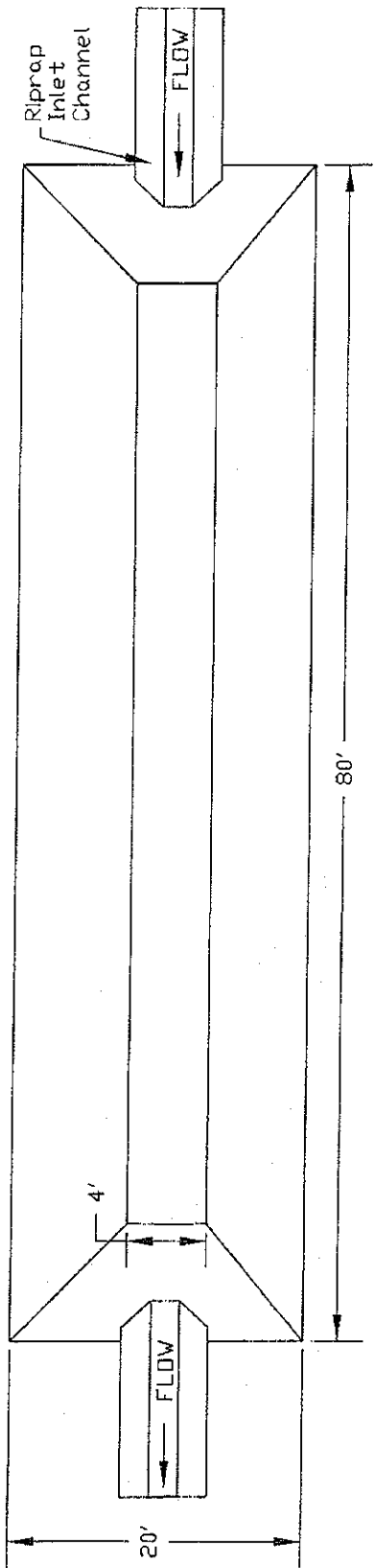

SIDE VIEW

Not To Scale

INCLINED LIMESTONE BED  
PLAN VIEW

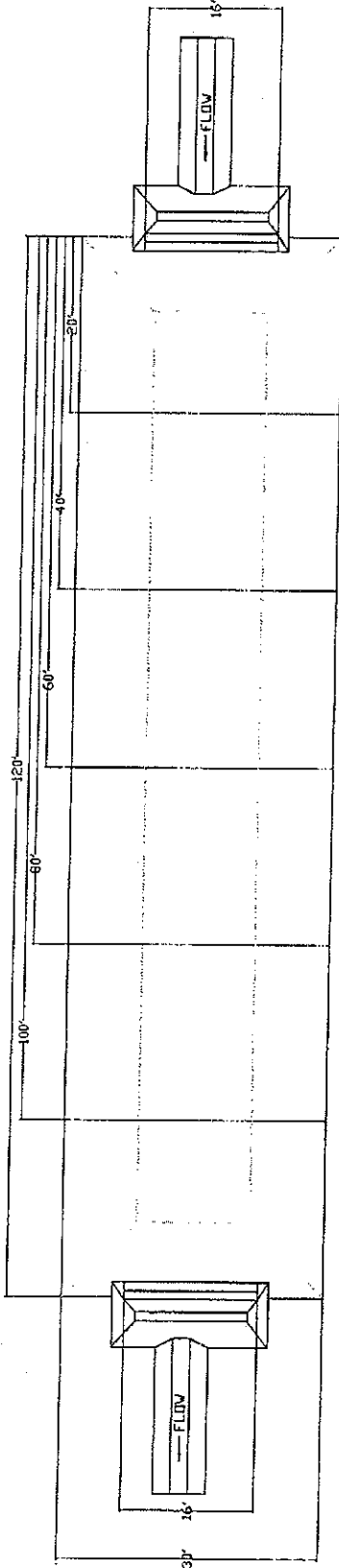

BUYER PAGE REQ. or P.O. No  
CB-23 035 DEP 13572  
INCLINED LIMESTONE BED

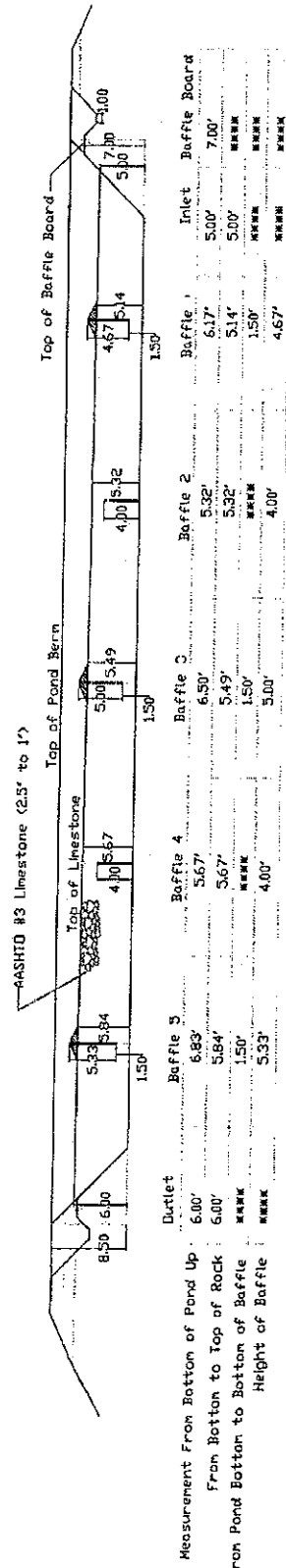

SIDE VIEW

SCALE  
1" = 20'

# LIMESTONE BED INLET DETAILS

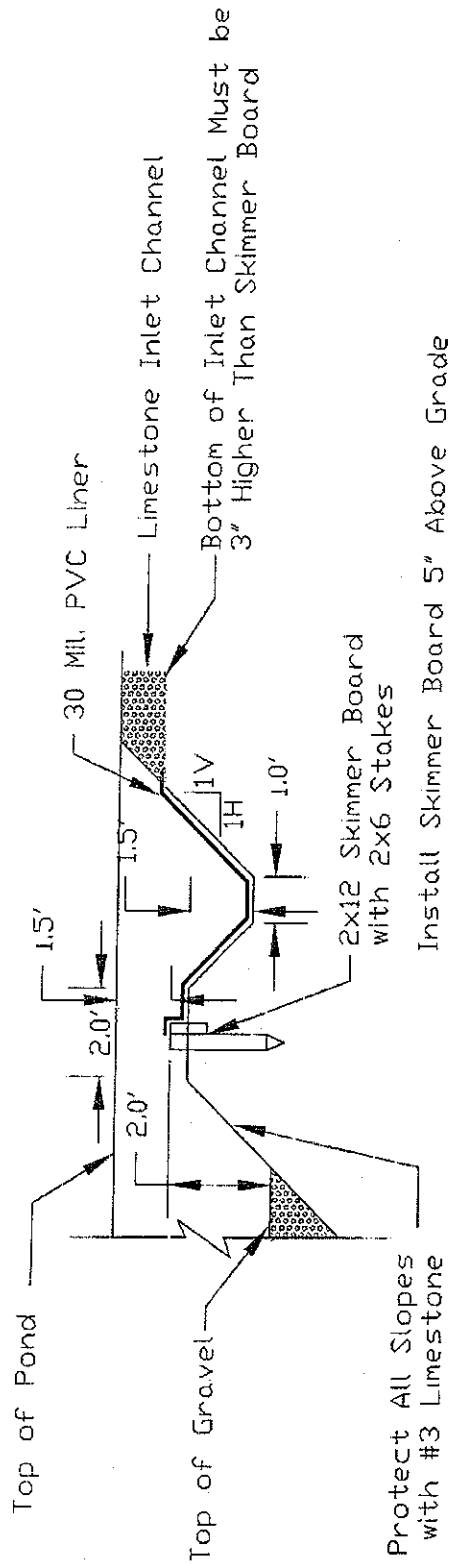

# OUTLET DETAILS

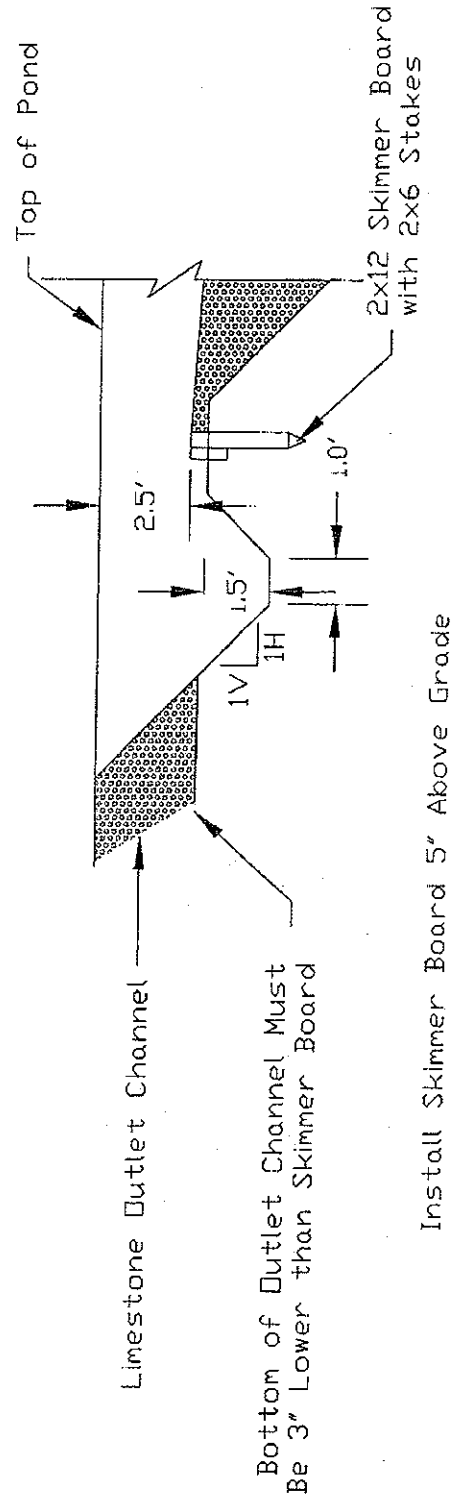

Not To Scale

BUYER CB-23	PAGE 036	REQ or P.D. No. DEP 13572
----------------	-------------	------------------------------

LIMESTONE BED INLET AND  
OUTLET DETAILS

# BAFFLE DETAILS

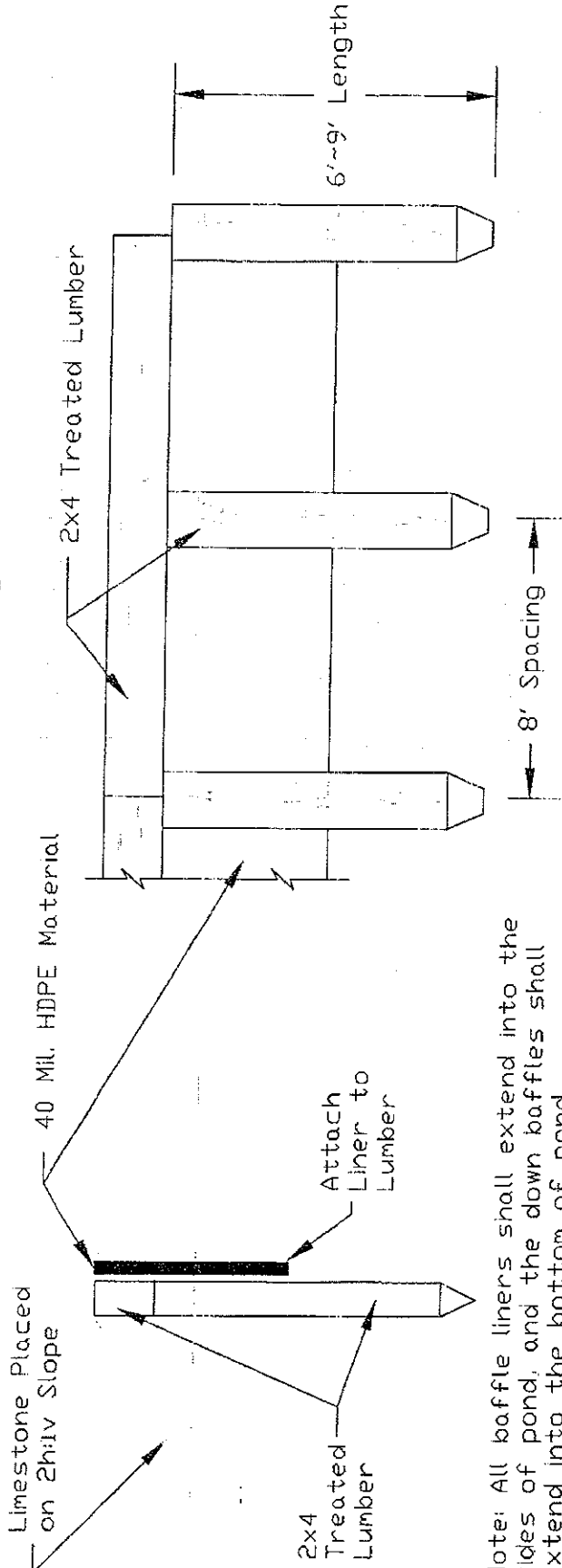

Note: All baffle liners shall extend into the sides of pond, and the down baffles shall extend into the bottom of pond.

BUYER CB-23	PAGE 037	REQ or PO No DEP 13572
----------------	-------------	---------------------------

# SKIMMER BOARD DETAILS

## SKIMMER BOARD DETAILS

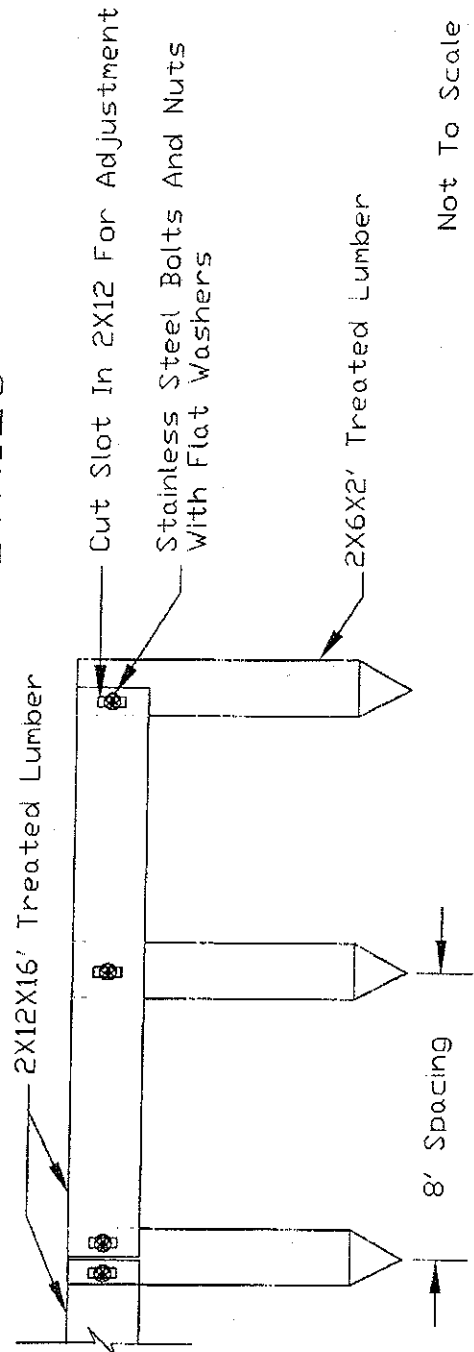

Not To Scale



# V - DITCH WITH LINER

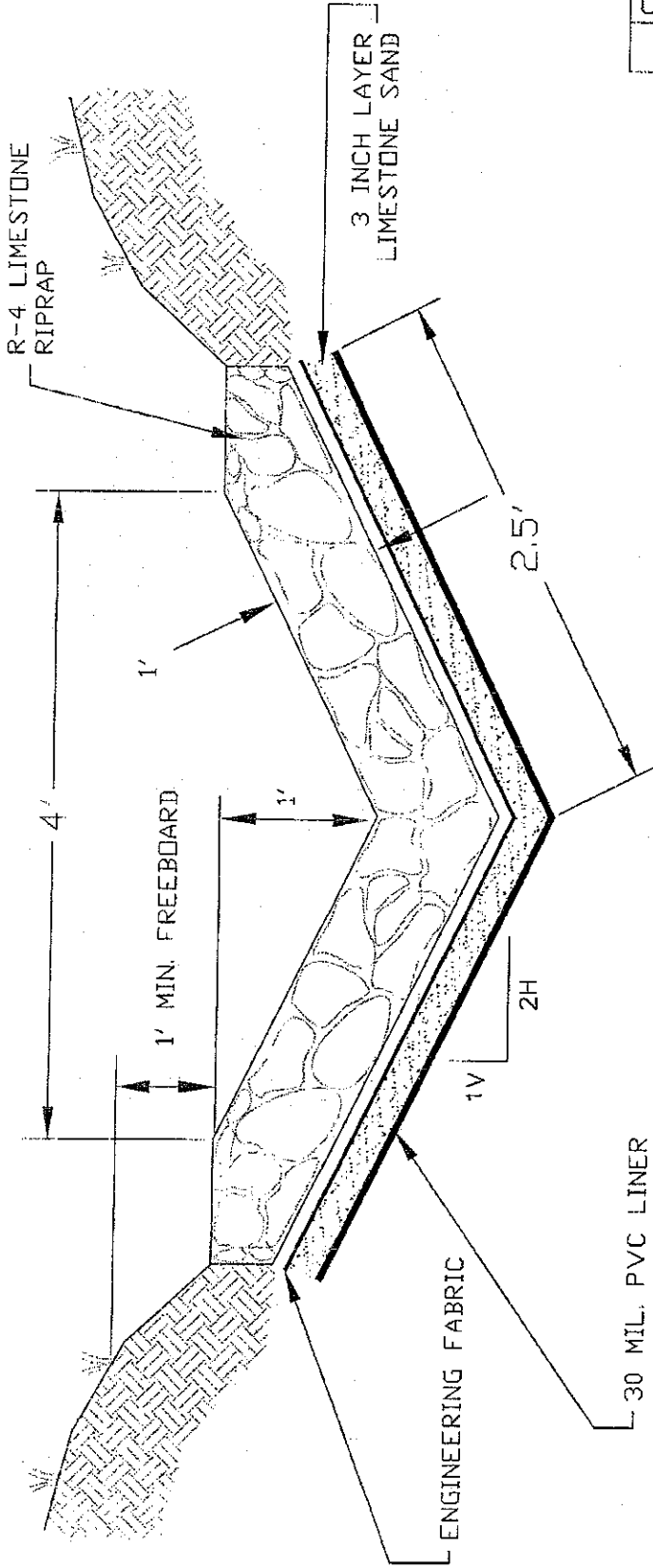

BUYER CB-23	PAGE 038	REQ or PD No DEP 13572
V - DITCH WITH LINER		

30 MIL. PVC LINER  
 LINER SHALL BE PLACED ON ROCK FREE MATERIAL, OR A LAYER OF SAND SHALL BE APPLIED BELOW LINER.

NOT TO SCALE

PAYMENT SHALL BE FOR ACTUAL LENGTH OF DITCH CONSTRUCTED.

R-4 RIPRAP (STANDARD) UNLESS OTHERWISE NOTED, RIPRAP SHALL BE DURABLE ROCK PLACED IN A 1.0 FOOT BLANKET. TWENTY-FIVE (25%) OF THE ROCK WILL BE OF 12 INCHES OR LARGER, THE REMAINING SEVENTY-FIVE (75%) SHALL BE WELL GRADED MATERIAL (MINIMUM 3 INCHES TO MAXIMUM 9 INCHES) OF SUFFICIENT ROCK SMALL ENOUGH TO FILL THE VOIDS BETWEEN THE LARGER ROCK. SHALE SHALL NOT BE USED FOR RIPRAP. IF RIPRAP STABILITY IS QUESTIONABLE, DURABILITY SHALL BE DETERMINED BY THE SODIUM SULPHATE TEST ASTM C 88/AASHTO T 104-77.

GROUTED V - DITCH

GROUTED V - DITCH

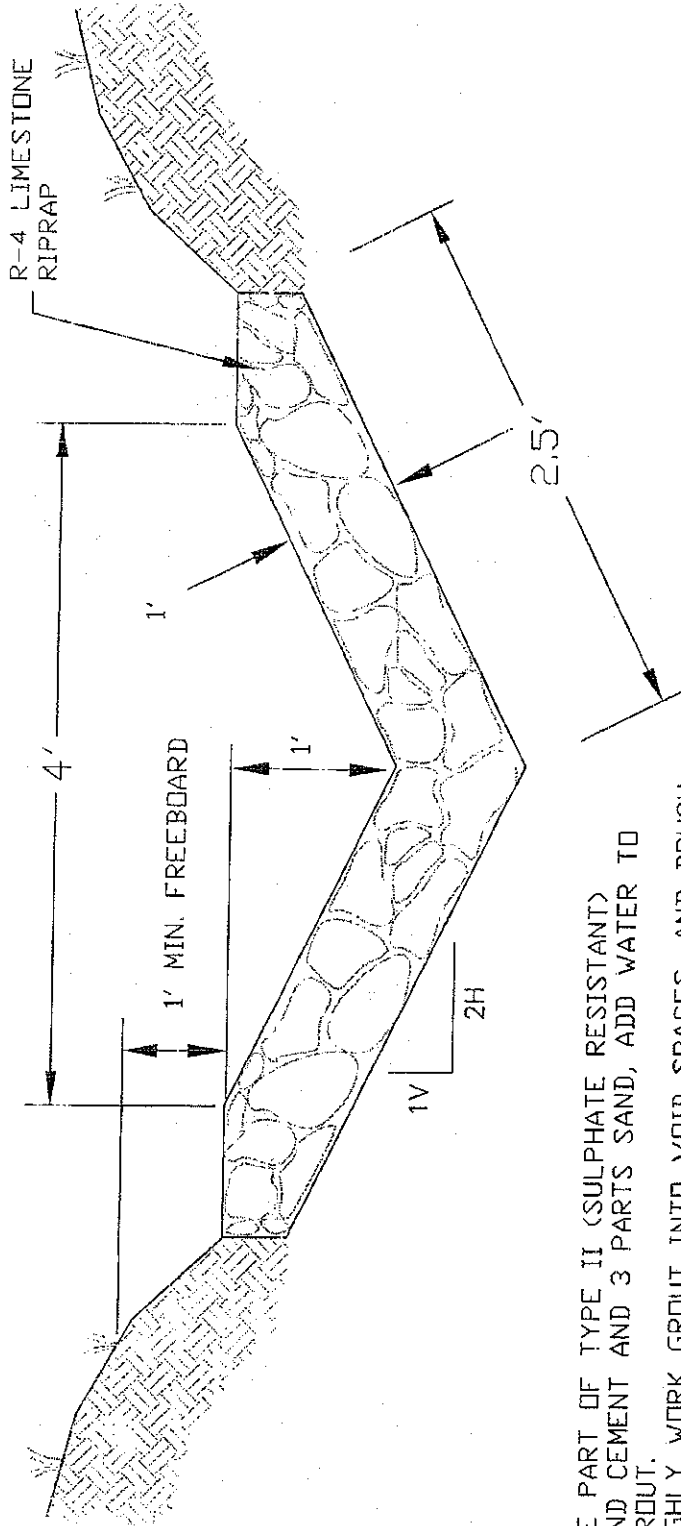

USE ONE PART OF TYPE II (SULPHATE RESISTANT) PORTLAND CEMENT AND 3 PARTS SAND, ADD WATER TO MAKE GROUT. THOROUGHLY WORK GROUT INTO VOID SPACES, AND BRUSH EXCESS GROUT OFF TOP OF RIPRAP STONES.

NOT TO SCALE

PAYMENT SHALL BE FOR ACTUAL LENGTH OF DITCH CONSTRUCTED.

R-4 RIPRAP (STANDARD) UNLESS OTHERWISE NOTED, RIPRAP SHALL BE DURABLE ROCK PLACED IN A 10 FOOT BLANKET. TWENTY-FIVE (25%) OF THE ROCK WILL BE OF 12 INCHES OR LARGER, THE REMAINING SEVENTY-FIVE (75%) SHALL BE WELL GRADED MATERIAL (MINIMUM 3 INCHES TO MAXIMUM 9 INCHES) OF SUFFICIENT ROCK SMALL ENOUGH TO FILL THE VOIDS BETWEEN THE LARGER ROCK. SHALE SHALL NOT BE USED FOR RIPRAP IF RIPRAP STABILITY IS QUESTIONABLE, DURABILITY SHALL BE DETERMINED BY THE SODIUM SULPHATE TEST ASTM C 88/AASHTO T 104-77.

Pipe casing shall be HDPE material with DR rating of 17 or stronger. Any alternate material must be approved by engineer.

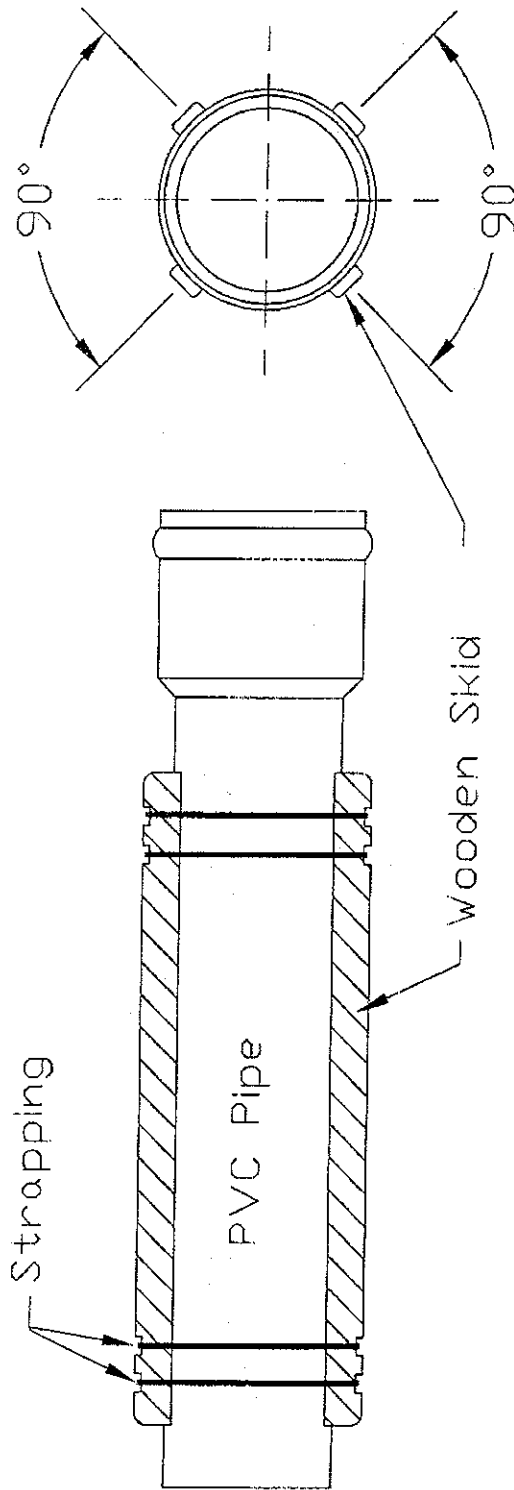

Nominal Pipe Size (Diameter, Inch)	Casing Size (Inside Diameter, Inch)	Maximum Skid Support Spacing (Feet)
4	8~10	4.7
6	10~12	6.3
8	14~16	7.4
10	16~18	8.5
12	18~20	9.6

Skids must provide sufficient height to permit clearance between bell joint and casing wall. Skids should be fastened securely to pipe with strapping, cables, or clamps. Wooden skids must be made from treated lumber. Casing size 12" and under = 4 skids.

# ANIMAL GUARD DETAILS

BUYER CB-23	PAGE 041	REQ. or PO No DEP 13572
----------------	-------------	----------------------------

ANIMAL GUARD

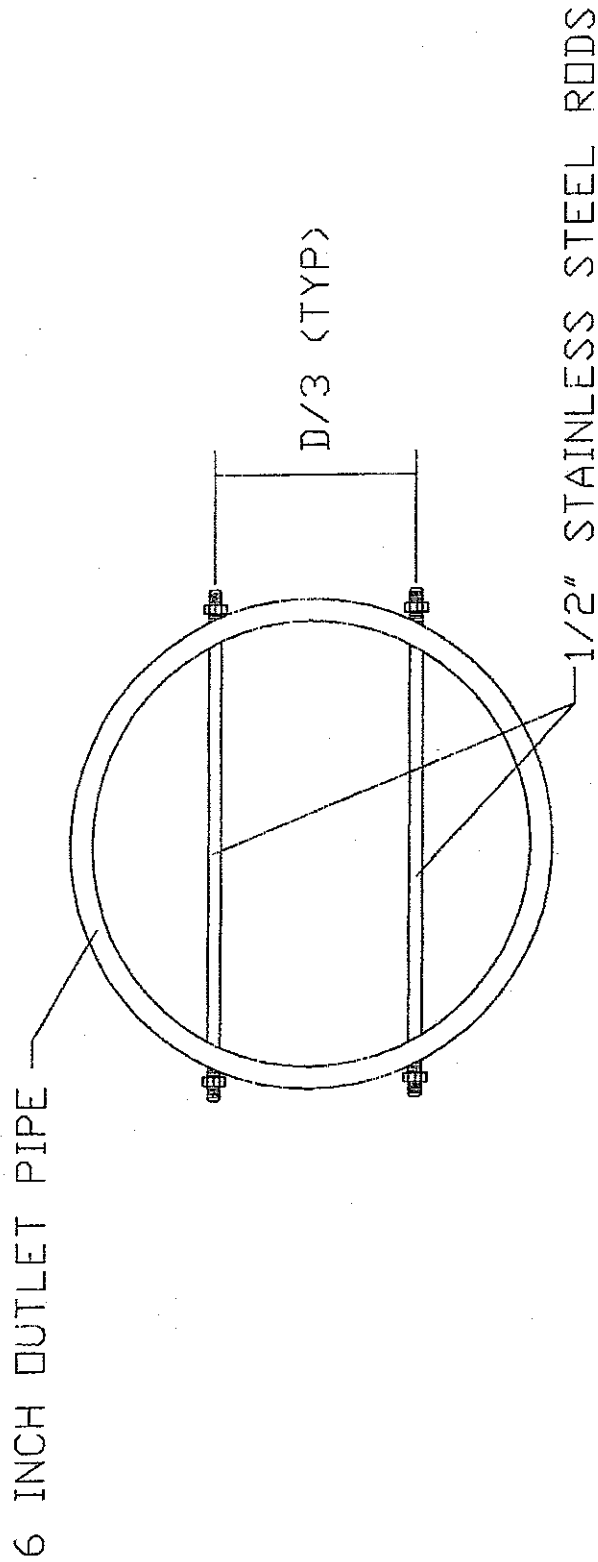

SPILL CONTAINMENT

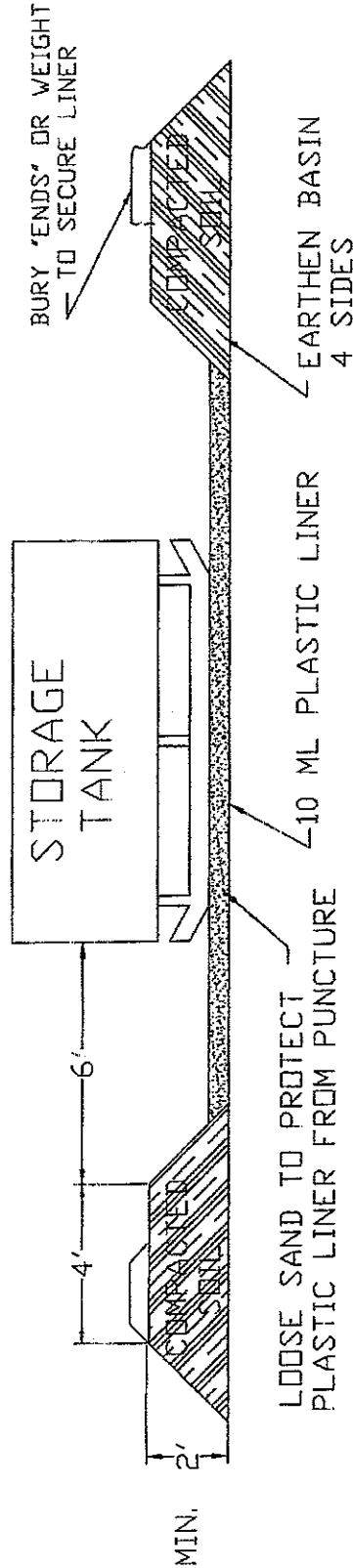

SELECTED HEIGHT OF EARTHEN BERM IS TO BE A TWO (2') FOOT MINIMUM OR ONE HUNDRED TEN PERCENT (110%) OF THE CAPACITY OF THE TANK(S) TOTAL VOLUME WITHIN THE BERM. A SIX (6") INCH FREEBOARD MUST BE INCLUDED.

NOTE: A TWO INCH (2") WATER REMOVAL DRAIN SHALL BE LOCATED AT THE LOWEST POINT IN THE BOTTOM OF THE CONTAINMENT VOLUME. IT SHALL CONNECT TO A NORMALLY CLOSED VALVE OUTSIDE THE DIKE. THE VALVE SHALL BE MANUALLY OPERATED AND PROTECTED FROM UNAUTHORIZED OPERATION. RAINWATER CONTAINED WITHIN THIS DIKE SHALL BE EXAMINED PRIOR TO RELEASE TO ENSURE THAT HARMFUL QUANTITIES OF FUELS AND LUBRICANTS ARE NOT DISCHARGED. ALTERNATE METHODS OF WATER REMOVAL WILL BE CONSIDERED FOR APPROVAL.

TANKS WITH SECONDARY CONTAINMENT MAY BE USED AS AN ALTERNATIVE.

HAY/STRAW BALE DIKE  
SEDIMENT CONTROL

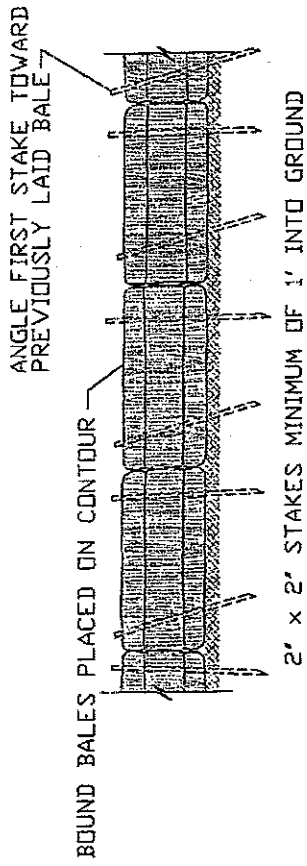

ANCHORING DETAIL

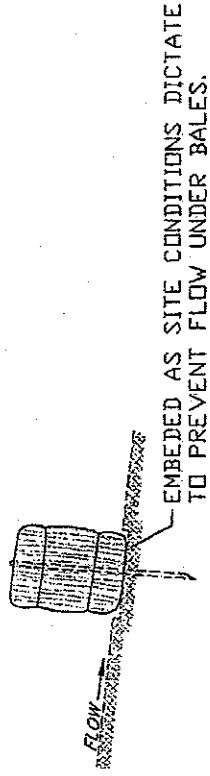

END VIEW

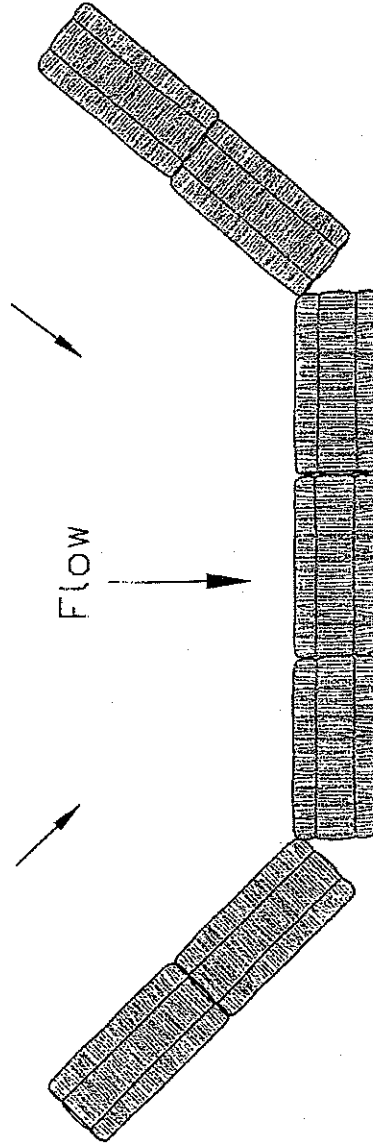

DESIGN TO FIT SITE CONDITIONS

SEDIMENT BARRIER  
TOP VIEW

NOT TO SCALE

# ACCESS ROAD UPGRADE

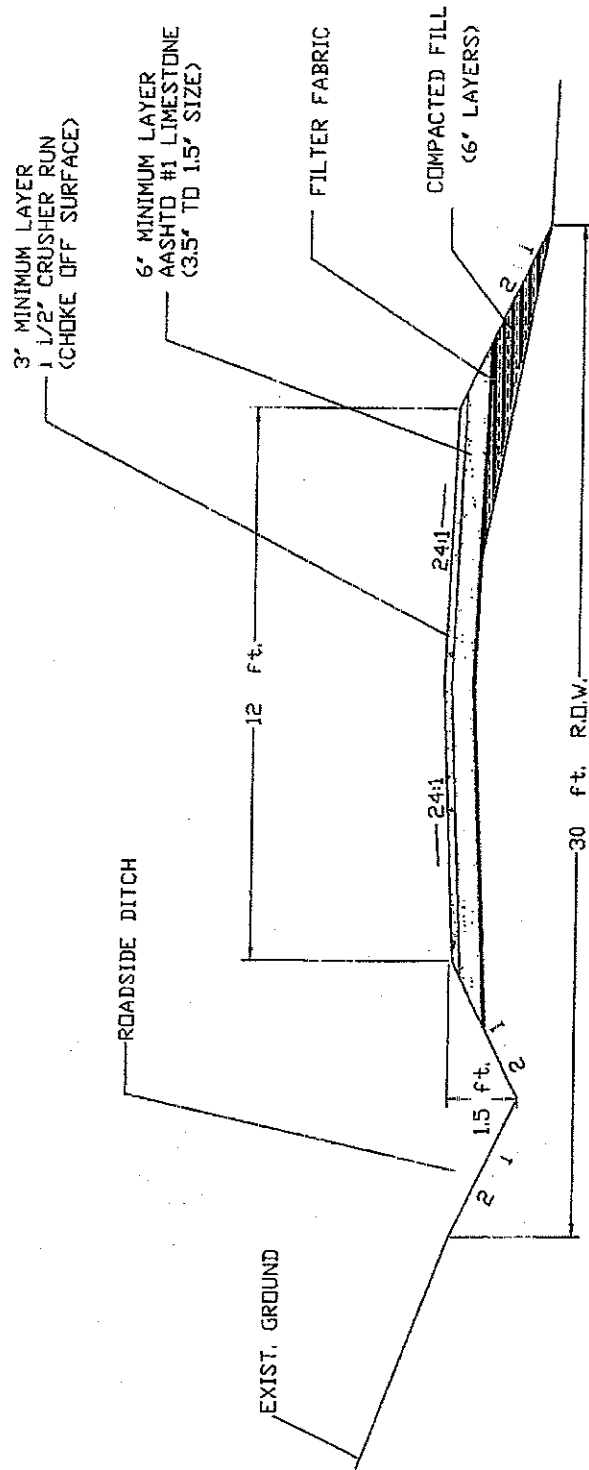

## TYPICAL SECTION

- NOTES:
- THE EXISTING ROAD SHALL BE REGRADED, SHAPED, AND ROCKED AS NECESSARY TO MEET THESE SPECIFICATIONS.
  - ANY TREES OR BRUSH WITHIN THE 30 FEET R.O.W. OF THE ROAD SHALL BE REMOVED.
  - ANY OVERHANGING TREE LIMBS IN THE R.O.W. AT A HEIGHT OF 15 FEET OR LESS SHALL BE REMOVED.

CULVERT INSTALLATION

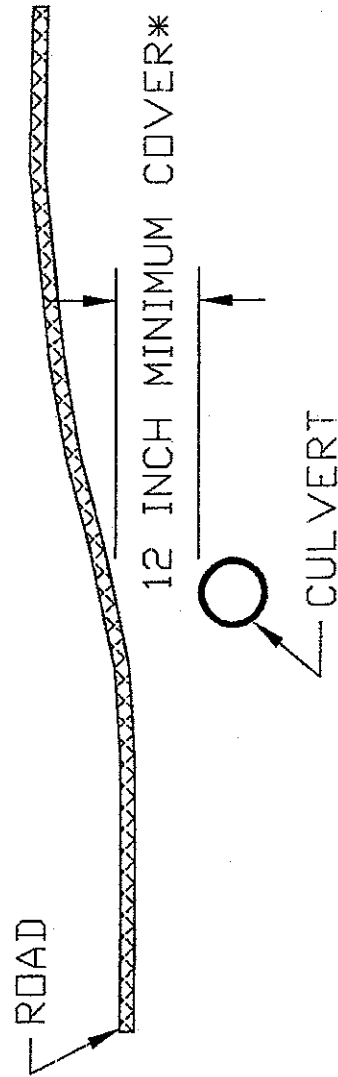
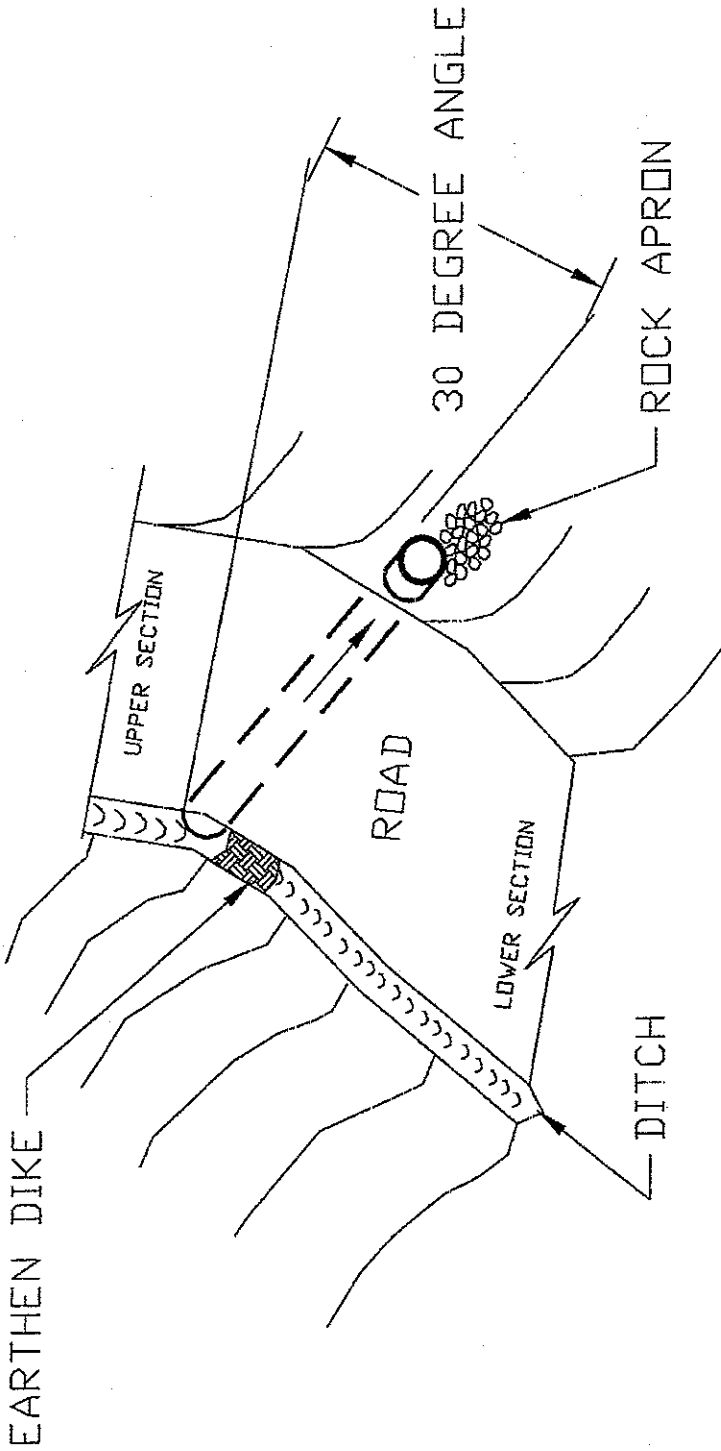

\*OR 1/2 CULVERT DIAMETER, WHICHEVER IS GREATER.



CULVERT INSTALLATION

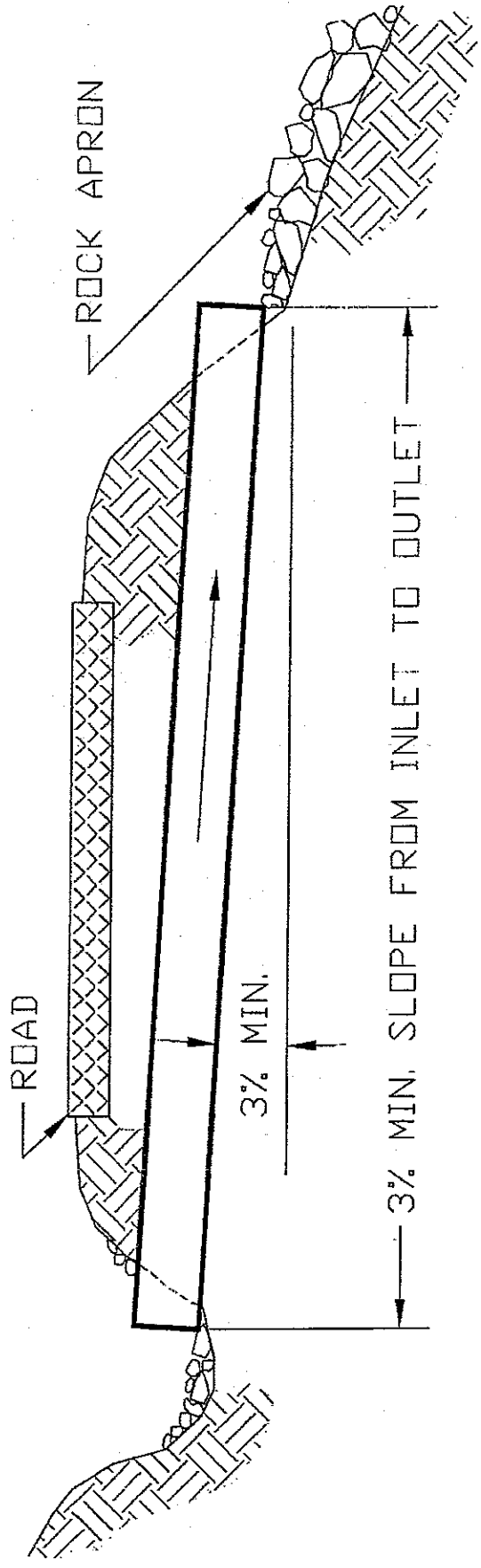

EARTHEN DIKE TO BE INSTALLED IN DITCH  
LINE BELOW CULVERT INLET

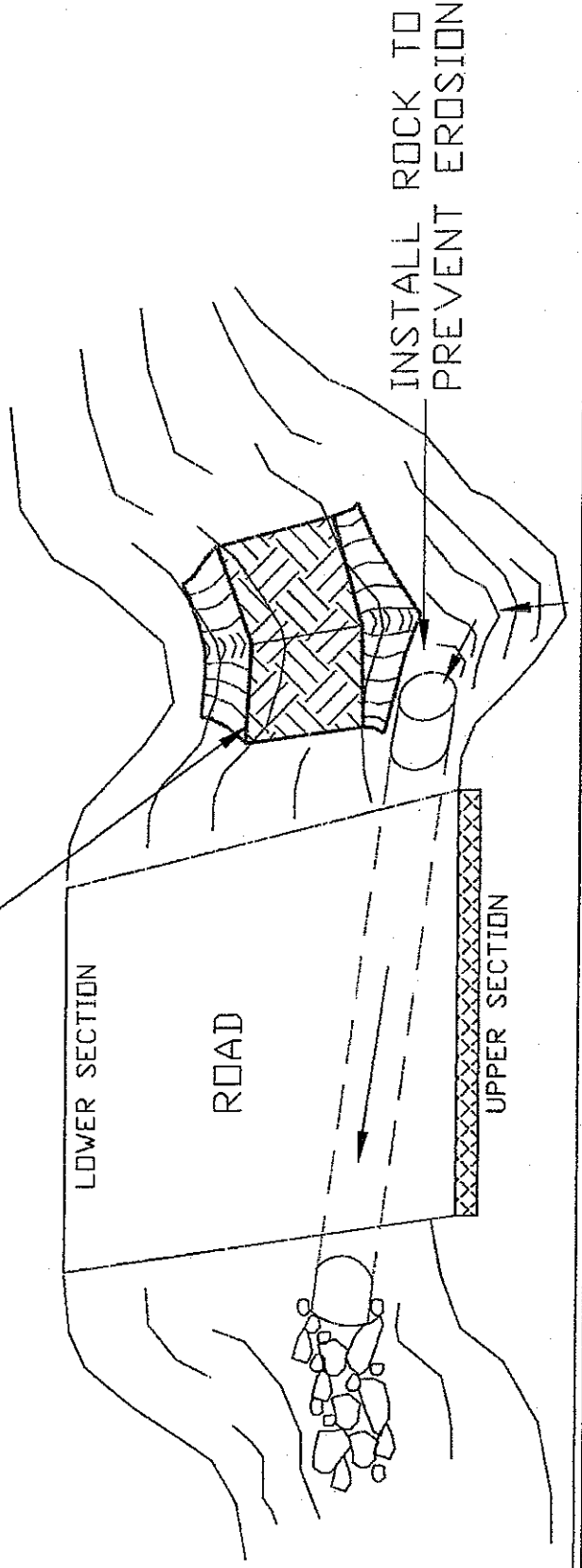

**AFFIDAVIT**

047

**West Virginia Code §5A-3-10a states:**

No contract or renewal of any contract may be awarded by the state or any of its political subdivisions to any vendor or prospective vendor when the vendor or prospective vendor or a related party to the vendor or prospective vendor is a debtor and the debt owned is an amount greater than one thousand dollars in the aggregate

**DEFINITIONS:**

"Debt" means any assessment, premium, penalty, fine, tax or other amount of money owed to the state or any of its political subdivisions because of a judgment, fine, permit violation, license assessment, defaulted workers' compensation premium, penalty or other assessment presently delinquent or due and required to be paid to the state or any of its political subdivisions, including any interest or additional penalties accrued thereon

"Debtor" means any individual, corporation, partnership, association, limited liability company or any other form or business association owing a debt to the state or any of its political subdivisions "Political subdivision" means any county commission; municipality; county board of education; any instrumentality established by a county or municipality; any separate corporation or instrumentality established by one or more counties or municipalities, as permitted by law; or any public body charged by law with the performance of a government function or whose jurisdiction is coextensive with one or more counties or municipalities "Related party" means a party, whether an individual, corporation, partnership, association, limited liability company or any other form or business association or other entity whatsoever, related to any vendor by blood, marriage, ownership or contract through which the party has a relationship of ownership or other interest with the vendor so that the party will actually or by effect receive or control a portion of the benefit, profit or other consideration from performance of a vendor contract with the party receiving an amount that meets or exceed five percent of the total contract amount

**EXCEPTION:**

The prohibition of this section does not apply where a vendor has contested any tax administered pursuant to chapter eleven of this code, workers' compensation premium, permit fee or environmental fee or assessment and the matter has not become final or where the vendor has entered into a payment plan or agreement and the vendor is not in default of any of the provisions of such plan or agreement

**LICENSING:**

Vendors must be licensed and in good standing in accordance with any and all state and local laws and requirements by any state or local agency of West Virginia, including, but not limited to, the West Virginia Secretary of State's Office, the West Virginia Tax Department, West Virginia Insurance Commission, or any other state agencies or political subdivision Furthermore, the vendor must provide all necessary releases to obtain information to enable the Director or spending unit to verify that the vendor is licensed and in good standing with the above entities

**CONFIDENTIALITY:**

The vendor agrees that he or she will not disclose to anyone, directly or indirectly, any such personally identifiable information or other confidential information gained from the agency, unless the individual who is the subject of the information consents to the disclosure in writing or the disclosure is made pursuant to the agency's policies, procedures and rules Vendors should visit [www state wv us/admin/purchase/privacy](http://www.state.wv.us/admin/purchase/privacy) for the Notice of Agency Confidentiality Policies.

Under penalty of law for false swearing (West Virginia Code, §61-5-3), it is hereby certified that the vendor acknowledges the information in this said affidavit and are in compliance with the requirements as stated.

Vendor's Name: MIDWAY RECLAMATION LLC

Authorized Signature: Nancy S. Somers Date: 3-22-07

BID BOND

048

KNOW ALL MEN BY THESE PRESENTS That we the undersigned \_\_\_\_\_  
of \_\_\_\_\_, as Principal and \_\_\_\_\_  
of \_\_\_\_\_ a corporation organized and existing under the laws of the State of \_\_\_\_\_  
with its principal office in the City of \_\_\_\_\_ as Surety are held and firmly bound unto the State  
of West Virginia as Obligee in the penal sum of \_\_\_\_\_ (\$ \_\_\_\_\_) for the payment of which  
well and truly to be made, we jointly and severally bind ourselves our heirs, administrators executors successors and assigns

The Condition of the above obligation is such that whereas the Principal has submitted to the Purchasing Section of the  
Department of Administration a certain bid or proposal attached herelo and made a part hereof to enter into a contract in writing for  
\_\_\_\_\_  
\_\_\_\_\_  
\_\_\_\_\_

NOW THEREFORE,

- (a) If said bid shall be rejected, or
- (b) If said bid shall be accepted and the Principal shall enter into a contract in accordance with the bid or proposal attached  
hereto and shall furnish any other bonds and insurance required by the bid or proposal and shall in all other respects perform the  
agreement created by the acceptance of said bid, then this obligation shall be null and void otherwise this obligation shall remain in full  
force and effect It is expressly understood and agreed that the liability of the Surety for any and all claims hereunder shall in no event,  
exceed the penal amount of this obligation as herein stated

The Surety for the value received, hereby stipulates and agrees that the obligations of said Surety and its bond shall be in no  
way impaired or affected by any extension of the time within which the Obligee may accept such bid, and said Surety does hereby  
waive notice of any such extension

IN WITNESS WHEREOF Principal and Surety have hereunto set their hands and seals, and such of them as are corporations  
have caused their corporate seals to be affixed hereunto and these presents to be signed by their proper officers, this

\_\_\_\_\_ day of \_\_\_\_\_ 20\_\_\_\_\_

Principal Corporate Seal

\_\_\_\_\_  
(Name of Principal)

By \_\_\_\_\_  
(Must be President or  
Vice President)

\_\_\_\_\_  
(Title)

Surety Corporate Seal

\_\_\_\_\_  
(Name of Surety)

\_\_\_\_\_  
Attorney-in-Fact

IMPORTANT - Surety executing bonds must be licensed in West Virginia to transact surety insurance Corporate seals must be affixed  
Power of attorney must be attached

BID BOND PREPARATION INSTRUCTIONS

049

AGENCY (A)  
RFQ/RFP# (B)

Bid Bond

- (A) W V State Agency  
(Stated on Page 1 Spending Unit")  
Request for Quotation Number (upper  
right corner of page #1)
  - (C) Your Company Name
  - (D) City, Location of your Company
  - (E) State, Location of your Company
  - (F) Surety Corporate Name
  - (G) City, Location of Surety
  - (H) State, Location of Surety
  - (I) State of Surety Incorporation
  - (J) City of Surety Incorporation
  - (K) Minimum amount of acceptable bid  
bond is 5% of total bid You may state  
' 5% of bid" or a specific amount on  
this line in words
  - (L) Amount of bond in figures
  - (M) Brief Description of scope of work
  - (N) Day of the month
  - (O) Month
  - (P) Year
  - (Q) Name of Corporation
  - (R) Raised Corporate Seal of Principal
  - (S) Signature of President or Vice  
President
  - (T) Title of person signing
  - (U) Raised Corporate Seal of Surety
  - (V) Corporate Name of Surety
  - (X) Signature of Attorney in Fact of the  
Surety
- NOTE: Dated, Power of Attorney with Raised  
Surety Seal must accompany this bid  
bond

KNOW ALL MEN BY THESE PRESENTS, That we, the undersigned,  
\_\_\_\_\_(C)\_\_\_\_\_ of \_\_\_\_\_(D)\_\_\_\_\_ \_\_\_\_\_(E)\_\_\_\_\_  
as Principal, and \_\_\_\_\_(F)\_\_\_\_\_ of \_\_\_\_\_(G)\_\_\_\_\_  
\_\_\_\_\_(H)\_\_\_\_\_, a corporation organized and existing under the laws  
of the State of \_\_\_\_\_(I)\_\_\_\_\_ with its principal office in the City of  
\_\_\_\_\_(J)\_\_\_\_\_, as Surety, are held and firmly bound unto The State  
of West Virginia, as Oblige, in the penal sum of \_\_\_\_\_(K)\_\_\_\_\_  
(\$ \_\_\_\_\_(L)\_\_\_\_\_) for the payment of which, well and truly to be made,  
we jointly and severally bind ourselves, our heirs, administrators, executors,  
successors and assigns

The Condition of the above obligation is such that whereas the Principal  
has submitted to the Purchasing Section of the Department of Administration  
a certain bid or proposal, attached hereto and made a part hereof to enter into a  
contract in writing for \_\_\_\_\_(M)\_\_\_\_\_

NOW THEREFORE

(a) If said bid shall be rejected, or  
(b) If said bid shall be accepted and the Principal shall enter into a  
contract in accordance with the bid or proposal attached hereto and shall furnish  
any other bonds and insurance required by the bid or proposal, and shall in all  
other respects perform the agreement created by the acceptance of said bid then  
this obligation shall be null and void, otherwise this obligation shall remain in full  
force and effect It is expressly understood and agreed that the liability of the  
Surety for any and all claims hereunder shall, in no event, exceed the penal  
amount of this obligation as herein stated

The Surety for value received, hereby stipulates and agrees that the  
obligations of said Surety and its bond shall be in no way impaired or affected by  
any extension of time within which the Oblige may accept such bid: and said  
Surety does hereby waive notice of any such extension.

IN WITNESS WHEREOF, Principal and Surety have hereunto set their  
hands and seals, and such of them as are corporations have caused their corporate  
seals to be affixed hereto and these presents to be signed by their proper officers,  
this \_\_\_\_\_(N)\_\_\_\_\_ day of \_\_\_\_\_(O)\_\_\_\_\_, 20 \_\_\_\_\_(P)\_\_\_\_\_.

Principal Corporate Seal

(R)

(U)  
Surety Corporate Seal

\_\_\_\_\_(Q)\_\_\_\_\_  
(Name of Principal)  
By \_\_\_\_\_(S)\_\_\_\_\_  
(Must be President or  
Vice President)  
\_\_\_\_\_(T)\_\_\_\_\_  
Title  
\_\_\_\_\_(V)\_\_\_\_\_  
(Name of Surety)  
\_\_\_\_\_(X)\_\_\_\_\_  
Attorney-in-Fact

IMPORTANT - Surety executing bonds must be licensed in West Virginia to  
transact surety insurance Corporate seals must be affixed, a power of attorney  
must be attached.

**BID BOND**

KNOW ALL MEN BY THESE PRESENTS, That we, the undersigned, Midway Reclamation, LLC.  
of West Milford, WV, as Principal, and United States Surety  
Compan of Timonium, MD, a corporation organized and existing under the laws of the State of  
MD with its principal office in the City of Timonium, as Surety, are held and firmly bound unto the State  
of West Virginia, as Obligee, in the penal sum of Five Percent of Amount Bid (\$ 5% ) for the payment of which,  
well and truly to be made, we jointly and severally bind ourselves, our heirs administrators, executors, successors and assigns.

The Condition of the above obligation is such that whereas the Principal has submitted to the Purchasing Section of the  
Department of Administration a certain bid or proposal, attached hereto and made a part hereof, to enter into a contract in writing for  
RFQ - DEP 13572 AML Project in Monongalia County, WV - According to Plans and Specifications

NOW THEREFORE,

- (a) If said bid shall be rejected, or
- (b) If said bid shall be accepted and the Principal shall enter into a contract in accordance with the bid or proposal attached  
hereto and shall furnish any other bonds and insurance required by the bid or proposal, and shall in all other respects perform the  
agreement created by the acceptance of said bid, then this obligation shall be null and void, otherwise this obligation shall remain in full  
force and effect. It is expressly understood and agreed that the liability of the Surety for any and all claims hereunder shall, in no event,  
exceed the penal amount of this obligation as herein stated

The Surety, for the value received, hereby stipulates and agrees that the obligations of said Surety and its bond shall be in no  
way impaired or affected by any extension of the time within which the Obligee may accept such bid, and said Surety does hereby  
waive notice of any such extension

IN WITNESS WHEREOF, Principal and Surety have hereunto set their hands and seals, and such of them as are corporations  
have caused their corporate seals to be affixed hereunto and these presents to be signed by their proper officers, this  
22nd day of March, 2007

Principal Corporate Seal

Midway Reclamation, LLC.  
(Name of Principal)

By: Nancy S. Somers  
(Must be President or  
Vice President)

OWNER  
(Title)

Surety Corporate Seal

United States Surety Company  
(Name of Surety)

By: Gregory T. Gordon  
Attorney-in-Fact  
Gregory T. Gordon, WV Resident Agent

# UNITED STATES SURETY COMPANY

Power of Attorney Number

46592

KNOWN ALL MEN BY THESE PRESENTS: That United States Surety Company (the "Company"), a corporation organized and existing under the laws of the State of Maryland, does hereby constitute and appoint: **Patricia Ann Fincke, Gregory T. Gordon, Larry D. Kerr, Allan L. McVey, Patricia A. Moye, Tammy M. Lloyd**

of the City of Charleston, State of West Virginia, its true and lawful Attorney(s)-in-Fact, each in their separate capacity if more than one is named above, to sign its name as surety to, and to execute, seal and acknowledge any and all bonds, undertakings, contracts and other written instruments in the nature thereof of the Company in its business of providing suretyship; guaranteeing the performance of contracts; and executing or guaranteeing bonds and undertakings required or permitted in any actions or proceedings allowed by law, subject to the following limitations:

**No single bond shall obligate the Company in excess of the sum of Three Million Dollars (\$3,000,000).**

This Power of Attorney is granted under and by authority of the following Resolutions adopted by the Board of Directors of United States Surety Company on the 29<sup>th</sup> day of July 1996.

IN WITNESS WHEREOF, United States Surety Company has caused these presents to be signed by its proper officers, and its corporate seal to be hereunto affixed this 19<sup>th</sup> day of July 2005

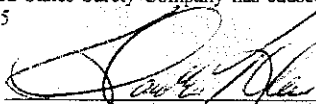
  
Richard E. Klein, President

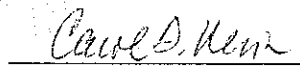
  
Carol T. Nevin, Assistant Secretary



STATE OF MARYLAND  
BALTIMORE COUNTY

SS:

On this 19<sup>th</sup> day of July, A. D. 2005, before me personally came Richard E. Klein, President of the United States Surety Company, and Carol T. Nevin, Assistant Secretary of said Company, with both of whom I am personally acquainted, who being by me severally duly sworn, said, that they, the said Richard E. Klein and Carol T. Nevin were respectively the President and Assistant Secretary of the United States Surety Company, the corporation described in and which executed the foregoing Power of Attorney.

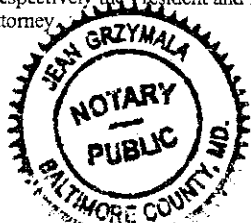

(Signed)

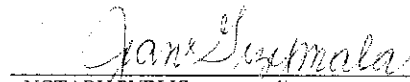

NOTARY PUBLIC  
My Commission expires the 1<sup>st</sup> day in December 2008

RESOLVED, that in connection with the surety insurance business of the Company, all bonds, undertakings, contracts and other instruments relating to said business may be signed, executed, and acknowledged by persons or entities appointed as Attorney(s)-in-Fact pursuant to any Power of Attorney issued in accordance with these resolutions ("Powers of Attorney"). All Powers of Attorney for and on behalf of the Company shall be executed in the name and on behalf of the Company, either by the Chair, the President, a Vice President jointly with the Secretary or an Assistant Secretary under their respective designations. The signature of such officers may be engraved, printed or lithographed. The signatures of such officers and the seal of the Company may be also be affixed by facsimile to any Power of Attorney or to any certificate relating thereto appointing Attorney(s)-in-Fact, for purposes only of executing and attesting bonds and undertakings and other writings obligatory in the nature thereof. Subject to any limitations set forth therein and unless such Power of Attorney is subsequently revoked, any such Power of Attorney or certificate bearing such facsimile signature or facsimile seal shall be valid and binding upon the Company, and any such Power of Attorney so executed and certified by such facsimile signature and facsimile seal shall be valid and binding upon the Company with respect to any bond or undertaking to which it is validly attached.

RESOLVED, that Attorney(s)-in-Fact shall have the power and authority, subject to the terms and limitations of the Power of Attorney issued to them and unless subsequently revoked to execute and deliver on behalf of the Company and to attach the seal of the Company to any and all bonds and undertakings, and other writings obligatory in the nature thereof, and any such instrument executed by such Attorney(s)-in-Fact shall be as binding upon the Company as if signed by the Company's Chair, the President, a Vice President, and sealed and attested to by the Corporate Secretary or an Assistant Secretary.

I, Carol T. Nevin, Assistant Secretary of United States Surety Company, do hereby certify that the foregoing is a true excerpt from the Resolution of the said Company as adopted by its Board of Directors on the 29<sup>th</sup> day of July, 1996, and that this Resolution is in full force and effect.

I, the undersigned Assistant Secretary of United States Surety Company, do hereby certify that the foregoing Power of Attorney is in full force and effect and has not been revoked.

In testimony whereof, I have hereunto set my hand and the seal of United States Surety Company on this 22<sup>nd</sup> day of March, 2001



  
Carol T. Nevin, Assistant Secretary