



State of West Virginia
 Department of Administration
 Purchasing Division
 2019 Washington Street East
 Post Office Box 50130
 Charleston, WV 25305-0130

Request for Quotation

RFQ NUMBER
06700178

PAGE
1

ADDRESS CORRESPONDENCE TO ATTENTION OF
**JOHN JOHNSTON
 304-558-2402**

RFQ COPY

VENDOR

**SPRAYER SPECIALTIES INC
 5149 NW 111 M STREET
 GRIMES IA 50111**

SHIP TO

**DIVISION OF HIGHWAYS
 ROUTE 3, BOX 68
 TRIADELPHIA, WV
 26059 304-238-1196**

DATE PRINTED 02/26/2007	TERMS OF SALE NET 30	SHIP VIA for.	F.O.B. TRIADELPHIA	FREIGHT TERMS SEE BELOW
BID OPENING DATE: 03/21/2007		BID OPENING TIME: 01:30PM		SHIP: ADD

LINE	QUANTITY	UOP	CAT. NO.	ITEM NUMBER	UNIT PRICE	AMOUNT
0001	3	EA		810-93	\$3,280 ⁰⁰	\$9,840 ⁰⁰
CP-50-RC TRUCK OVERHEAD SPRAY SYSTEM OR EQUAL						
0002	6	EA		810-93	\$1,080 ⁰⁰	\$6,480 ⁰⁰
3000 GALLON VERTICAL POLYETHYLENE STORAGE TANKS						
NORWESCO MODEL #40754 OR EQUAL. DIMENSIONS: 95" DIAMETER, 107" HEIGHT						
0003	1	LS		962-24-00-000	\$1,200 ⁰⁰	\$1,200 ⁰⁰
FREIGHT						
<p>TO PROVIDE THREE CALCOTE PEDESTAL MODEL CP-50-RC OR EQUAL MULTIFUNCTIONAL LIQUID DEICER DISPENSING SYSTEMS AND SIX 3000 GALLON NORWESCO MODEL #40754 OR EQUAL POLYETHYLENE STORAGE TANKS.</p> <p>THE WV DIVISION OF HIGHWAYS PERSONNEL WILL PERFORM ALL SITE PREPARATION AND COMPLETE INSTALLATION.</p> <p>THE MODEL/BRAND/SPECIFICATIONS NAMED HEREIN ESTABLISH THE ACCEPTABLE LEVEL OF QUALITY ONLY AND ARE NOT</p>						

RECEIVED
 2007 MAR 21 A 9:54
 PURCHASING DIVISION
 STATE OF WV

SEE REVERSE SIDE FOR TERMS AND CONDITIONS

SIGNATURE **[Signature]** TELEPHONE **800-351-1587** DATE **3/18/07**
 TITLE **PRESIDENT** FEIN **42-1062551** ADDRESS CHANGES TO BE NOTED ABOVE

WHEN RESPONDING TO RFQ, INSERT NAME AND ADDRESS IN SPACE ABOVE LABELED 'VENDOR'



State of West Virginia
 Department of Administration
 Purchasing Division
 2019 Washington Street East
 Post Office Box 50130
 Charleston, WV 25305-0130

Request for Quotation

RFQ NUMBER
06700178

PAGE
2

ADDRESS CORRESPONDENCE TO ATTENTION OF
JOHN JOHNSTON 304-558-2402

RFQ COPY
 TYPE NAME/ADDRESS HERE

DIVISION OF HIGHWAYS

ROUTE 3, BOX 68
 TRIADELPHIA, WV
 26059 304-238-1196

BIDDER

SHIP TO

DATE PRINTED	TERMS OF SALE	SHIP VIA	F.O.B.	FREIGHT TERMS
02/26/2007	NET 30	Car.	Triadelphia	Previous Page
BID OPENING DATE: 03/21/2007		BID OPENING TIME		01:30PM SHIP ADD

LINE	QUANTITY	UOP	CAT NO	ITEM NUMBER	UNIT PRICE	AMOUNT
<p>INTENDED TO REFLECT A PREFERENCE OR FAVOR ANY PARTICULAR BRAND OR VENDOR. VENDORS WHO ARE BIDDING ALTERNATES SHOULD SO STATE AND INCLUDE PERTINENT LITERATURE AND SPECIFICATIONS. FAILURE TO PROVIDE INFORMATION FOR ANY ALTERNATES MAY BE GROUNDS FOR REJECTION OF THE BID. THE STATE RESERVES THE RIGHT TO WAIVE MINOR IRREGULARITIES IN BIDS OR SPECIFICATIONS IN ACCORDANCE WITH SECTION 148-1-4(F) OF THE WEST VIRGINIA LEGISLATIVE RULES AND REGULATIONS.</p> <p>REQUIREMENTS OF WV. DEPT. OF TRANS. SPECIAL PROVISION 109.20 PRICE ADJUST. FOR LOAD LIMIT VIOL. DTD 02/25/91 SHALL APPLY TO ALL MATERIALS SUPPLIED BY THIS CONTRACT, INCL. THOSE LOADED BY VENDOR INTO DOH OWNED AND/OR RENTED TRUCKS. THIS PROVISION MAY BE OBTAINED FROM: DIR. OF CONSTRUCTION, BLDG. 5., ROOM A729, 1900 KANAWHA BLVD. E., CHARLESTON, WV. 25305-0430.</p> <p>PLEASE CALL 24 HOURS BEFORE ANY DELIVERY AT 304-238-1196.</p> <p>SEE ATTACHED</p> <p>VENDOR PREFERENCE CERTIFICATE</p> <p>CERTIFICATION AND APPLICATION* IS HEREBY MADE FOR PREFERENCE IN ACCORDANCE WITH WEST VIRGINIA CODE, 5A-3-37 (DOES NOT APPLY TO CONSTRUCTION CONTRACTS).</p> <p>A. APPLICATION IS MADE FOR 2.5% PREFERENCE FOR THE REASON CHECKED:</p> <p>() BIDDER IS AN INDIVIDUAL RESIDENT VENDOR AND HAS RESIDED CONTINUOUSLY IN WEST VIRGINIA FOR FOUR (4) YEARS IMMEDIATELY PRECEDING THE DATE OF THIS CERTIFICATION; OR</p>						

SEE REVERSE SIDE FOR TERMS AND CONDITIONS			
SIGNATURE	TELEPHONE	DATE	
<i>Robert K. O.</i>	800-351-1587	3/18/07	
TITLE	FERN	ADDRESS CHANGES TO BE NOTED ABOVE	
President	42-1062551		

WHEN RESPONDING TO RFQ, INSERT NAME AND ADDRESS IN SPACE ABOVE LABELED 'VENDOR'



State of West Virginia
 Department of Administration
 Purchasing Division
 2019 Washington Street East
 Post Office Box 50130
 Charleston, WV 25305-0130

Request for Quotation

RFQ NUMBER
06700178

PAGE
3

ADDRESS CORRESPONDENCE TO ATTENTION OF
JOHN JOHNSTON 304-558-2402

RFQ COPY
 TYPE NAME/ADDRESS HERE

DIVISION OF HIGHWAYS

ROUTE 3, BOX 68
 TRIADELPHIA, WV
 26059 304-238-1196

DATE PRINTED	TERMS OF SALE	SHIP VIA	FOB	FREIGHT TERMS
02/26/2007	Net 30	RAT	Triadelphia	See Pg. #1
BID OPENING DATE: 03/21/2007		BID OPENING TIME 01:30PM		

LINE	QUANTITY	UOP	CAT NO	ITEM NUMBER	UNIT PRICE	AMOUNT
<p>() BIDDER IS A PARTNERSHIP, ASSOCIATION OR CORPORATION RESIDENT VENDOR AND HAS MAINTAINED ITS HEAD-QUARTERS OR PRINCIPAL PLACE OF BUSINESS CONTINUOUSLY IN WEST VIRGINIA FOR FOUR (4) YEARS IMMEDIATELY PRECEDING THE DATE OF THIS CERTIFICATION; OR 80% OF THE OWNERSHIP INTEREST OF BIDDER IS HELD BY ANOTHER INDIVIDUAL, PARTNERSHIP, ASSOCIATION OR CORPORATION RESIDENT VENDOR WHO HAS MAINTAINED ITS HEADQUARTERS OR PRINCIPAL PLACE OF BUSINESS CONTINUOUSLY IN WEST VIRGINIA FOR FOUR (4) YEARS IMMEDIATELY PRECEDING THE DATE OF THIS CERTIFICATION; OR</p> <p>() BIDDER IS A CORPORATION NONRESIDENT VENDOR WHICH HAS AN AFFILIATE OR SUBSIDIARY WHICH EMPLOYS A MINIMUM OF ONE HUNDRED STATE RESIDENTS AND WHICH HAS MAINTAINED ITS HEADQUARTERS OR PRINCIPAL PLACE OF BUSINESS WITHIN WEST VIRGINIA CONTINUOUSLY FOR THE FOUR (4) YEARS IMMEDIATELY PRECEDING THE DATE OF THIS CERTIFICATION.</p> <p>B. APPLICATION IS MADE FOR 2.5% PREFERENCE FOR THE REASON CHECKED:</p> <p>() BIDDER IS A RESIDENT VENDOR WHO CERTIFIES THAT, DURING THE LIFE OF THE CONTRACT, ON AVERAGE AT LEAST 75% OF THE EMPLOYEES WORKING ON THE PROJECT BEING BID ARE RESIDENTS OF WEST VIRGINIA WHO HAVE RESIDED IN THE STATE CONTINUOUSLY FOR THE TWO YEARS IMMEDIATELY PRECEDING SUBMISSION OF THIS BID;</p> <p>OR</p> <p>() BIDDER IS A NONRESIDENT VENDOR EMPLOYING A MINIMUM OF ONE HUNDRED STATE RESIDENTS OR IS A NONRESIDENT VENDOR WITH AN AFFILIATE OR SUBSIDIARY WHICH MAINTAINS ITS HEADQUARTERS OR PRINCIPAL PLACE OF BUSINESS WITHIN WEST VIRGINIA EMPLOYING A MINIMUM</p>						

SEE REVERSE SIDE FOR TERMS AND CONDITIONS

SIGNATURE <i>Robert L. ...</i>	TELEPHONE 800-351-1587	DATE 3/18/07
TITLE <i>President</i>	FEIN 42-1062551	ADDRESS CHANGES TO BE NOTED ABOVE

WHEN RESPONDING TO RFQ, INSERT NAME AND ADDRESS IN SPACE ABOVE LABELED 'VENDOR'



State of West Virginia
 Department of Administration
 Purchasing Division
 2019 Washington Street East
 Post Office Box 50130
 Charleston, WV 25305-0130

Request for Quotation

RFQ NUMBER
 06700178

PAGE
 4

ADDRESS CORRESPONDENCE TO ATTENTION OF
 JOHN JOHNSTON
 304-558-2402

RFQ COPY
 TYPE NAME/ADDRESS HERE

VENDOR

CITY/STATE

DIVISION OF HIGHWAYS

ROUTE 3, BOX 68
 TRIADDELPHIA, WV
 26059 304-238-1196

DATE PRINTED 02/26/2007	TERMS OF SALE Net 30	SHIP VIA Fed	FOB Triadelphia	FREIGHT TERMS Ship & Add
BID OPENING DATE: 03/21/2007		BID OPENING TIME		01:30PM

LINE	QUANTITY	UOP	CAT NO	ITEM NUMBER	UNIT PRICE	AMOUNT
<p>OF ONE HUNDRED STATE RESIDENTS WHO CERTIFIES THAT, DURING THE LIFE OF THE CONTRACT, ON AVERAGE AT LEAST 75% OF THE EMPLOYEES OR BIDDERS' AFFILIATE'S OR SUBSIDIARY'S EMPLOYEES ARE RESIDENTS OF WEST VIRGINIA WHO HAVE RESIDED IN THE STATE CONTINUOUSLY FOR THE TWO YEARS IMMEDIATELY PRECEDING SUBMISSION OF THIS BID.</p> <p>BIDDER UNDERSTANDS IF THE SECRETARY OF TAX & REVENUE DETERMINES THAT A BIDDER RECEIVING PREFERENCE HAS FAILED TO CONTINUE TO MEET THE REQUIREMENTS FOR SUCH PREFERENCE, THE SECRETARY MAY ORDER THE DIRECTOR OF PURCHASING TO: (A) RESCIND THE CONTRACT OR PURCHASE ORDER ISSUED; OR (B) ASSESS A PENALTY AGAINST SUCH BIDDER IN AN AMOUNT NOT TO EXCEED 5% OF THE BID AMOUNT AND THAT SUCH PENALTY WILL BE PAID TO THE CONTRACTING AGENCY OR DEDUCTED FROM ANY UNPAID BALANCE ON THE CONTRACT OR PURCHASE ORDER.</p> <p>BY SUBMISSION OF THIS CERTIFICATE, BIDDER AGREES TO DISCLOSE ANY REASONABLY REQUESTED INFORMATION TO THE PURCHASING DIVISION AND AUTHORIZES THE DEPARTMENT OF TAX AND REVENUE TO DISCLOSE TO THE DIRECTOR OF PURCHASING APPROPRIATE INFORMATION VERIFYING THAT BIDDER HAS PAID THE REQUIRED BUSINESS TAXES, PROVIDED THAT SUCH INFORMATION DOES NOT CONTAIN THE AMOUNTS OF TAXES PAID NOR ANY OTHER INFORMATION DEEMED BY THE TAX COMMISSIONER TO BE CONFIDENTIAL.</p> <p>UNDER PENALTY OF LAW FOR FALSE SWEARING (WEST VIRGINIA CODE 61-5-3), BIDDER HEREBY CERTIFIES THAT THIS CERTIFICATE IS TRUE AND ACCURATE IN ALL RESPECTS; AND THAT IF A CONTRACT IS ISSUED TO BIDDER AND IF ANYTHING CONTAINED WITHIN THIS CERTIFICATE CHANGES DURING THE TERM OF THE CONTRACT, BIDDER WILL NOTIFY THE PURCHASING DIVISION IN WRITING IMMEDIATELY.</p>						

SEE REVERSE SIDE FOR TERMS AND CONDITIONS.

SIGNATURE <i>[Signature]</i>	TELEPHONE 800-351-1587	DATE 3/18/07
TITLE President	FEIN 42-1062551	ADDRESS CHANGES TO BE NOTED ABOVE

WHEN RESPONDING TO RFQ, INSERT NAME AND ADDRESS IN SPACE ABOVE LABELED 'VENDOR'



State of West Virginia
 Department of Administration
 Purchasing Division
 2019 Washington Street East
 Post Office Box 50130
 Charleston, WV 25305-0130

Request for Quotation

RFQ NUMBER
 06700178

PAGE
 5

ADDRESS CORRESPONDENCE TO ATTENTION OF
 JOHN JOHNSTON
 304-558-2402

VENDOR

RFQ COPY
 TYPE NAME/ADDRESS HERE

SHIP TO

DIVISION OF HIGHWAYS
 ROUTE 3, BOX 68
 TRIADELPHIA, WV
 26059 304-238-1196

DATE PRINTED 02/26/2007	TERMS OF SALE NET 30	SHIP VIA RPT	FOB TRIADELPHIA	FREIGHT TERMS SHIP & ADD
BID OPENING DATE: 03/21/2007		BID OPENING TIME		01:30PM

LINE	QUANTITY	UOP	CAT. NO.	ITEM NUMBER	UNIT PRICE	AMOUNT
				BIDDER: SPRAYER SPECIALTIES, Inc.		
				DATE: 3/18/07		
				SIGNED: [Signature]		
				TITLE: PRESIDENT		
<p>* CHECK ANY COMBINATION OF PREFERENCE CONSIDERATION(S) IN EITHER "A" OR "B", OR BOTH "A" AND "B" WHICH YOU ARE ENTITLED TO RECEIVE. YOU MAY REQUEST UP TO THE MAXIMUM 5% PREFERENCE FOR BOTH "A" AND "B". (REV. 12/00)</p> <p>NOTICE</p> <p>A SIGNED BID MUST BE SUBMITTED TO:</p> <p>DEPARTMENT OF ADMINISTRATION PURCHASING DIVISION BUILDING 15 2019 WASHINGTON STREET, EAST CHARLESTON, WV 25305-0130</p> <p>THE BID SHOULD CONTAIN THIS INFORMATION ON THE FACE OF THE ENVELOPE OR THE BID MAY NOT BE CONSIDERED:</p> <p>SEALED BID</p>						

SEE REVERSE SIDE FOR TERMS AND CONDITIONS

SIGNATURE: [Signature] TELEPHONE: 800-351-1587 DATE: 3/18/07

TITLE: PRESIDENT FEIN: 42-1062551 ADDRESS CHANGES TO BE NOTED ABOVE

WHEN RESPONDING TO RFQ, INSERT NAME AND ADDRESS IN SPACE ABOVE LABELED 'VENDOR'



State of West Virginia
 Department of Administration
 Purchasing Division
 2019 Washington Street East
 Post Office Box 50130
 Charleston, WV 25305-0130

Request for Quotation

RFQ NUMBER
 06700178

PAGE
 6

ADDRESS CORRESPONDENCE TO ATTENTION OF:
 JOHN JOHNSTON
 304-558-2402

VENDOR

RFQ COPY
 TYPE NAME/ADDRESS HERE

SHIP TO

DIVISION OF HIGHWAYS
 ROUTE 3, BOX 68
 TRIADELPHIA, WV
 26059 304-238-1196

DATE PRINTED 02/26/2007	TERMS OF SALE Net 30	SHIP VIA PRT	F.O.B. Triadelphia	FREIGHT TERMS SHIP ADD
BID OPENING DATE: 03/21/2007		BID OPENING TIME 01:30PM		

LINE	QUANTITY	UOP	CAT NO.	ITEM NUMBER	UNIT PRICE	AMOUNT
BUYER:			33			
RFQ. NO.:			06700178			
BID OPENING DATE AND TIME						
PLEASE PROVIDE A FAX NUMBER IN CASE IT IS NECESSARY TO CONTACT YOU REGARDING YOUR BID: ----- 515-986-9257 -----						
CONTACT PERSON (PLEASE PRINT CLEARLY): ----- ROBERT Killian -----						
***** THIS IS THE END OF RFQ 06700178 ***** TOTAL:						\$17,520 ⁰⁰

SEE REVERSE SIDE FOR TERMS AND CONDITIONS

SIGNATURE: *[Signature]* TELEPHONE: 800-351-1587 DATE: 3/18/07
 TITLE: PRESIDENT FEIN: 42-1062551 ADDRESS CHANGES TO BE NOTED ABOVE

WHEN RESPONDING TO RFQ, INSERT NAME AND ADDRESS IN SPACE ABOVE LABELED 'VENDOR'

CALCOTE PEDESTAL MODEL CP-50-RC

TECHNICAL SPECIFICATIONS

DESCRIPTION:

The Calcote Pedestal, Model CP-50-RC is a multifunctional liquid deicer dispensing system. It is designed to prewet solid deicing materials by the truckload or front end loader bucket. In addition to these two functions, it is capable of loading and unloading truck mounted prewet tanks. The unload function allows the liquid deicer to be returned to the bulk storage tank at the end of the season or if the tank needs to be drained for maintenance.

The system is free standing and does not require a mounting post or a fixed base for mounting. All fabricated steel components of the unit are hot dip galvanized for corrosion protection; base, main body, and spray arm.

PHYSICAL DIMENSIONS:

Pedestal Height	10' 4"
Spray Arm Height (horizontal position)	9' 4"
Spray Head (distance from pivot)	8' 6"
Pedestal Base	3' x 3' x 3 5'

SPRAY ARM:

Movement of the spray arm up and down is accomplished manually by a hand winch rated at 800 pounds. The effective height adjustment range for overhead liquid deicer application to truckloads is 11' 3" to 7' 3". Flexible PVC hose from the pump outlet to the spray arm allows for easy movement of the arm in cold temperatures encountered during winter operation. The arm is 1 1/4" galvanized steel pipe.

SPRAY HEAD:

The spray head is made of 1 1/4" sch 80 PVC and has four (4) 1" brass spray nozzles spaced at 15" intervals. The nozzle spacing forms a rectangular spray pattern. The pattern size is controlled by a 1 1/4" Poly ball valve connected to the inlet of the spray head. Spray nozzle spacing can be easily configured to meet specific needs.

PUMP / MOTOR ASSEMBLY:

The stainless steel centrifugal pump has a 2" inlet, a 1 1/2" outlet, and a rated flow of 60 gpm in typical installations. The pump is close coupled to a 2 hp, 3450 rpm, TEFC, 230 volt single phase motor. The pump motor assembly is housed for protection in a rotationally molded, UV stabilized polyethylene enclosure. Electrical wiring from the pump motor to the electrical control box is contained in LIQUITIGHT flexible conduit with LIQUITIGHT connectors at both ends. The assembly is mounted to the Pedestal base.

A F F I D A V I T

West Virginia Code §5A-3-10a states:

No contract or renewal of any contract may be awarded by the state or any of its political subdivisions to any vendor or prospective vendor when the vendor or prospective vendor or a related party to the vendor or prospective vendor is a debtor and the debt owned is an amount greater than one thousand dollars in the aggregate

DEFINITIONS:

"Debt" means any assessment, premium, penalty, fine, tax or other amount of money owed to the state or any of its political subdivisions because of a judgment, fine, permit violation, license assessment, defaulted workers' compensation premium, penalty or other assessment presently delinquent or due and required to be paid to the state or any of its political subdivisions, including any interest or additional penalties accrued thereon.

"Debtor" means any individual, corporation, partnership, association, limited liability company or any other form or business association owing a debt to the state or any of its political subdivisions. "Political subdivision" means any county commission; municipality; county board of education; any instrumentality established by a county or municipality; any separate corporation or instrumentality established by one or more counties or municipalities, as permitted by law; or any public body charged by law with the performance of a government function or whose jurisdiction is coextensive with one or more counties or municipalities. "Related party" means a party, whether an individual, corporation, partnership, association, limited liability company or any other form or business association or other entity whatsoever, related to any vendor by blood, marriage, ownership or contract through which the party has a relationship of ownership or other interest with the vendor so that the party will actually or by effect receive or control a portion of the benefit, profit or other consideration from performance of a vendor contract with the party receiving an amount that meets or exceeds five percent of the total contract amount.

EXCEPTION:

The prohibition of this section does not apply where a vendor has contested any tax administered pursuant to chapter eleven of this code, workers' compensation premium, permit fee or environmental fee or assessment and the matter has not become final or where the vendor has entered into a payment plan or agreement and the vendor is not in default of any of the provisions of such plan or agreement.

LICENSING:

Vendors must be licensed and in good standing in accordance with any and all state and local laws and requirements by any state or local agency of West Virginia, including, but not limited to, the West Virginia Secretary of State's Office, the West Virginia Tax Department, West Virginia Insurance Commission, or any other state agencies or political subdivision. Furthermore, the vendor must provide all necessary releases to obtain information to enable the Director or spending unit to verify that the vendor is licensed and in good standing with the above entities.

CONFIDENTIALITY:

The vendor agrees that he or she will not disclose to anyone, directly or indirectly, any such personally identifiable information or other confidential information gained from the agency, unless the individual who is the subject of the information consents to the disclosure in writing or the disclosure is made pursuant to the agency's policies, procedures and rules. Vendors should visit www.state.wv.us/admin/purchase/privacy for the Notice of Agency Confidentiality Policies.

Under penalty of law for false swearing (West Virginia Code, §61-5-3), it is hereby certified that the vendor acknowledges the information in this said affidavit and are in compliance with the requirements as stated.

Vendor's Name: SPRAYKR SPECIALTIES, INC.

Authorized Signature: T. KILL Date: 3/18/07

CHEMFLO 1 2 3 4

END SUCTION CENTRIFUGAL PUMP FEATURES

- CHEMFLO 1,2,3 & 4 - INVESTMENT-CAST, 316 STAINLESS
CHEMFLO 5,6,7, 8 & 9 - 316 CF8M STAINLESS STEEL HOUSING,
SEAL HOUSING & IMPELLER
- PRESSURES - 105-460 FEET HEAD
- FLOWS - 100-450 GPM
- CHEMFLO 1,2,3,4 PUMPAKS FOR 56C AND 145TC ELECTRIC MOTORS
CHEMFLO 5, 6, 7, 8, AND 9 PUMPAKS FOR ELECTRIC MOTOR FRAME
SIZE 145TC THROUGH 286TCS
- HORSEPOWER - 1-40 HP
- OPTIONAL ELASTOMERS AVAILABLE
- HYDRAULIC MOTOR DRIVE AVAILABLE

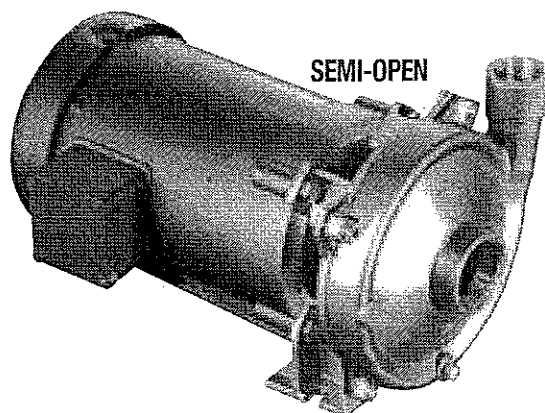

CHEMFLO 1 & 2

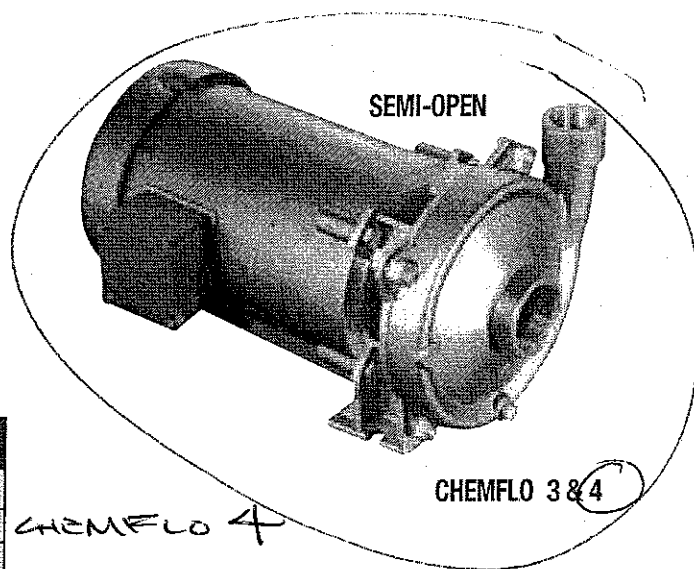

CHEMFLO 3 & 4

MODEL	Suction	Discharge
CHEMFLO 1 & 2	1 1/2" NPT	1" NPT
CHEMFLO 3 & 4	2" NPT	1 1/2" NPT
CHEMFLO 5	2" ANSI 125 Flange	1 1/2" ANSI 125 Flange
CHEMFLO 6	3" ANSI 125 Flange	2" ANSI 125 Flange
CHEMFLO 7	2" ANSI 125 Flange	1" ANSI 125 Flange
CHEMFLO 8	3" ANSI 125 Flange	1 1/2" ANSI 125 Flange
CHEMFLO 9	2" ANSI 125 Flange	1" ANSI 125 Flange

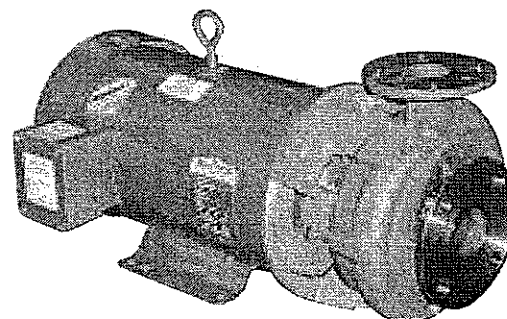

CHEMFLO 5

CHEMFLO 3 Pump Performance Curves

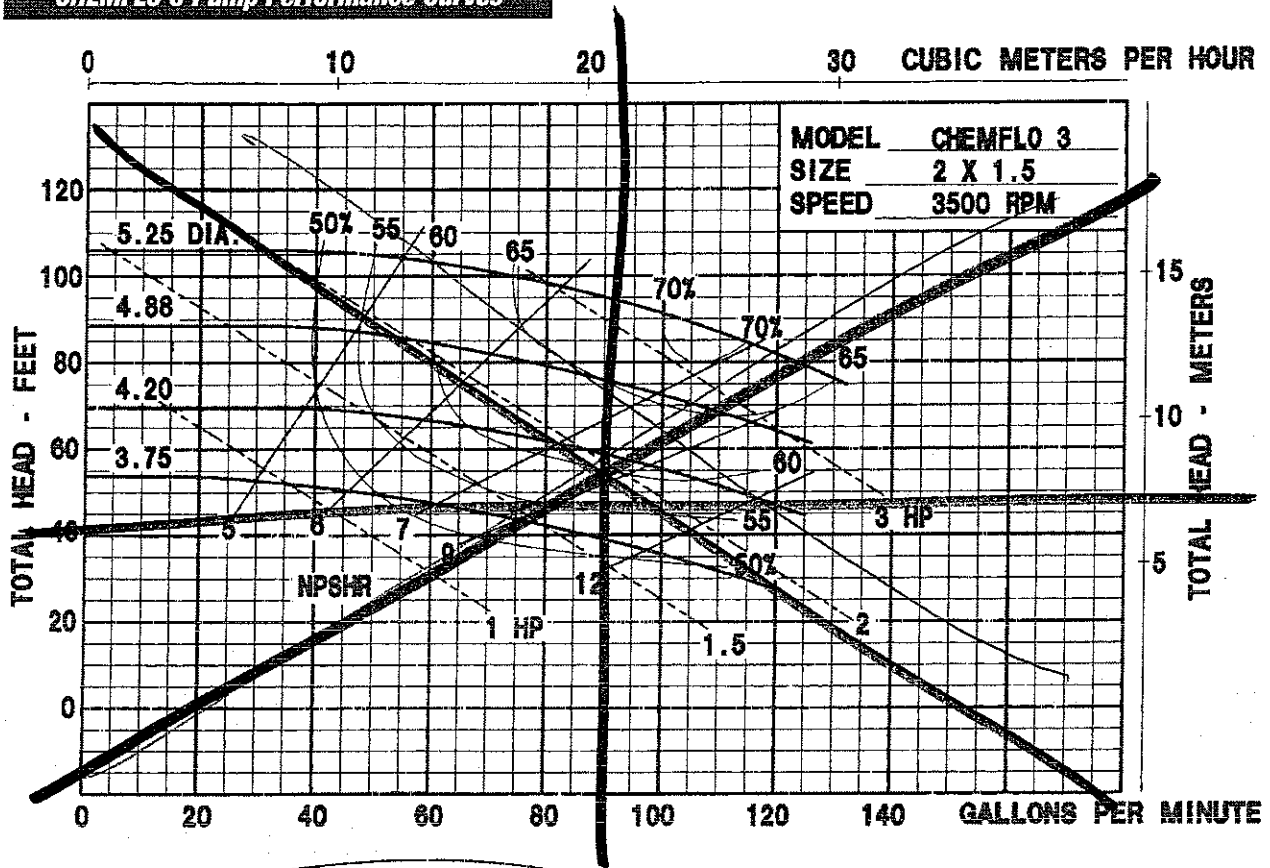

CHEMFLO 4 Pump Performance Curves

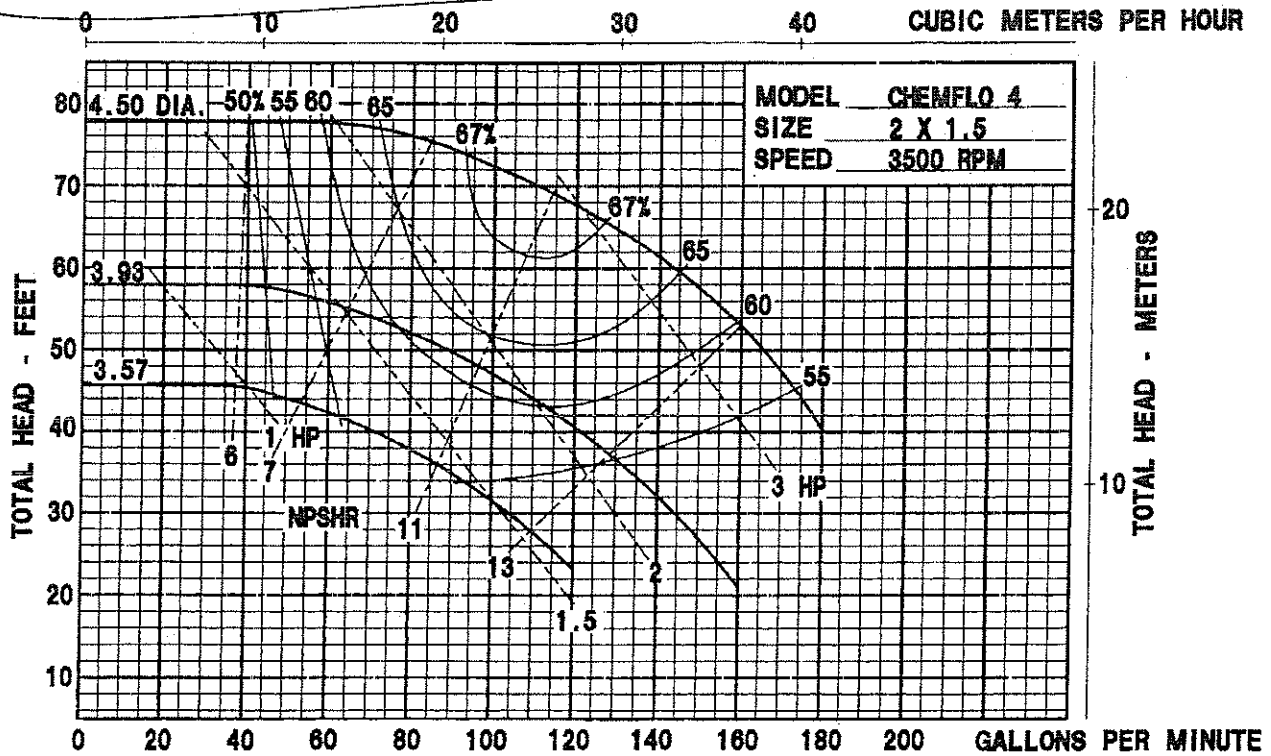

CHEMFLO 4

CHEMFLO 1&2 Dimensions

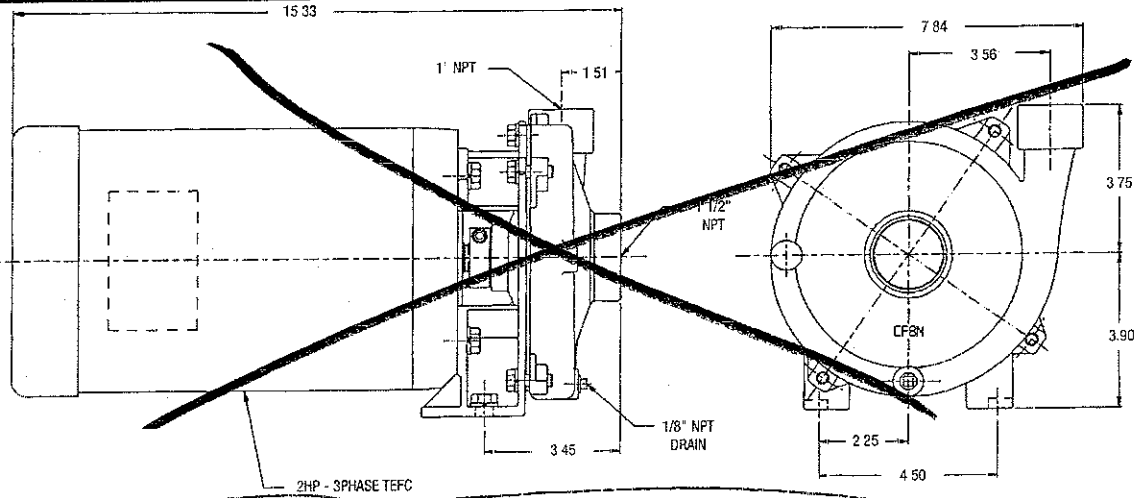

CHEMFLO 3&4 Dimensions

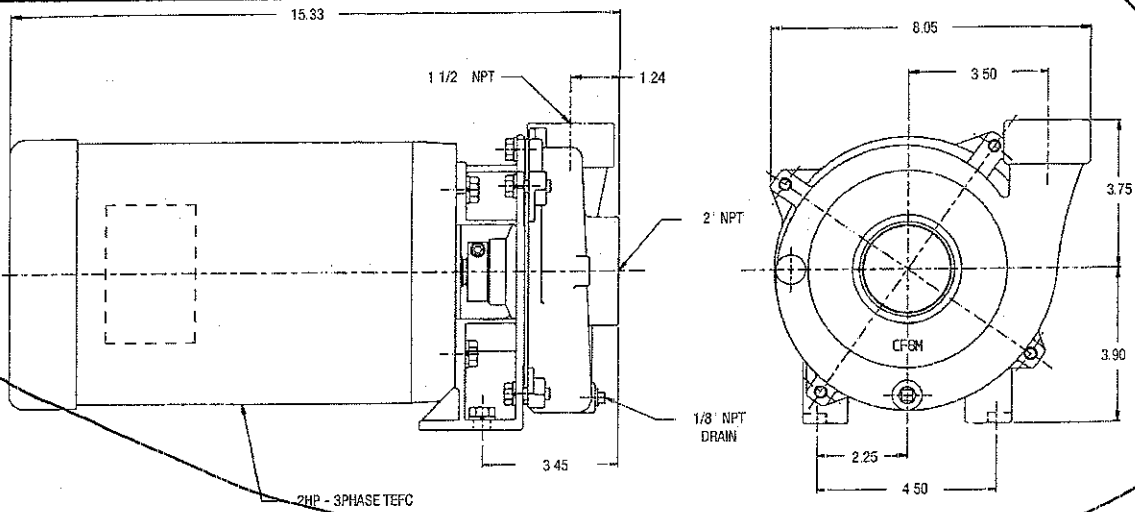

CHEMFLO 5 Dimensions

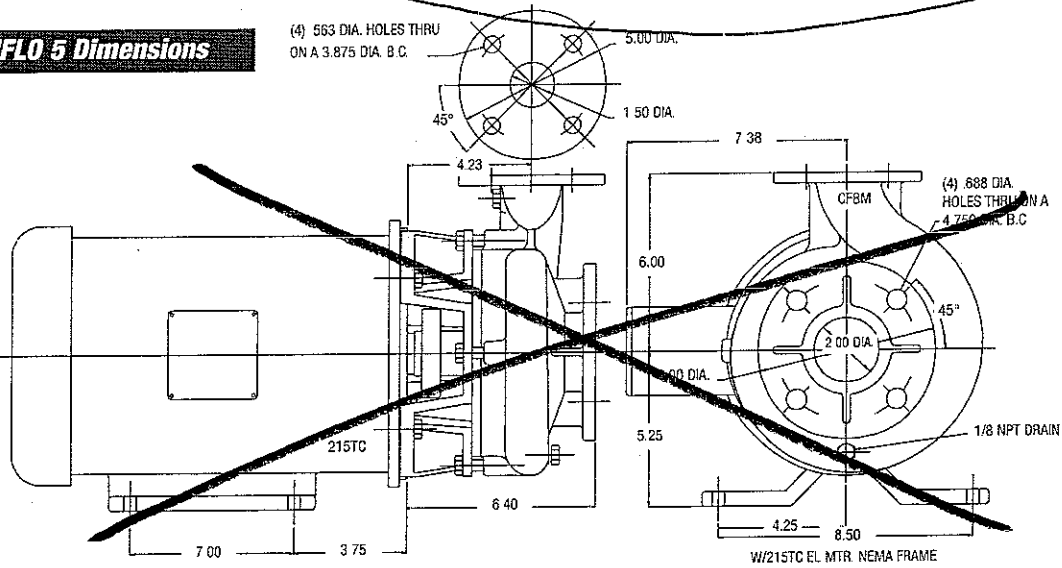

Deicing -

Controlling

PRODUCT GUIDE



SPRAYER SPECIALTIES, INC.

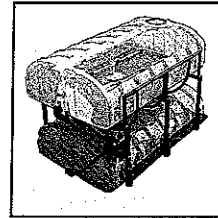

Salt Brine System
page two

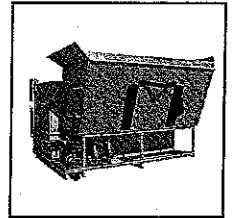

NEW - Salt Brine System
page three

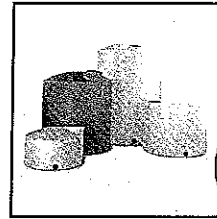

Storage Tanks
page three

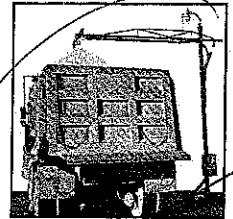

Transfer Applications
page four

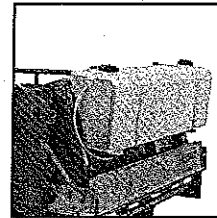

Pre-wetting Applications
pages six & seven

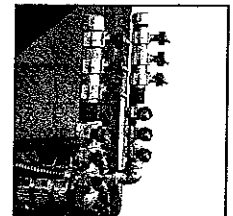
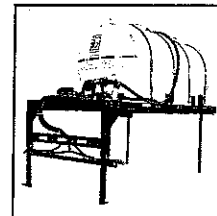
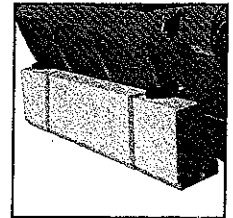

Applications
pages eight - eleven



SALT BRINE SYSTEM

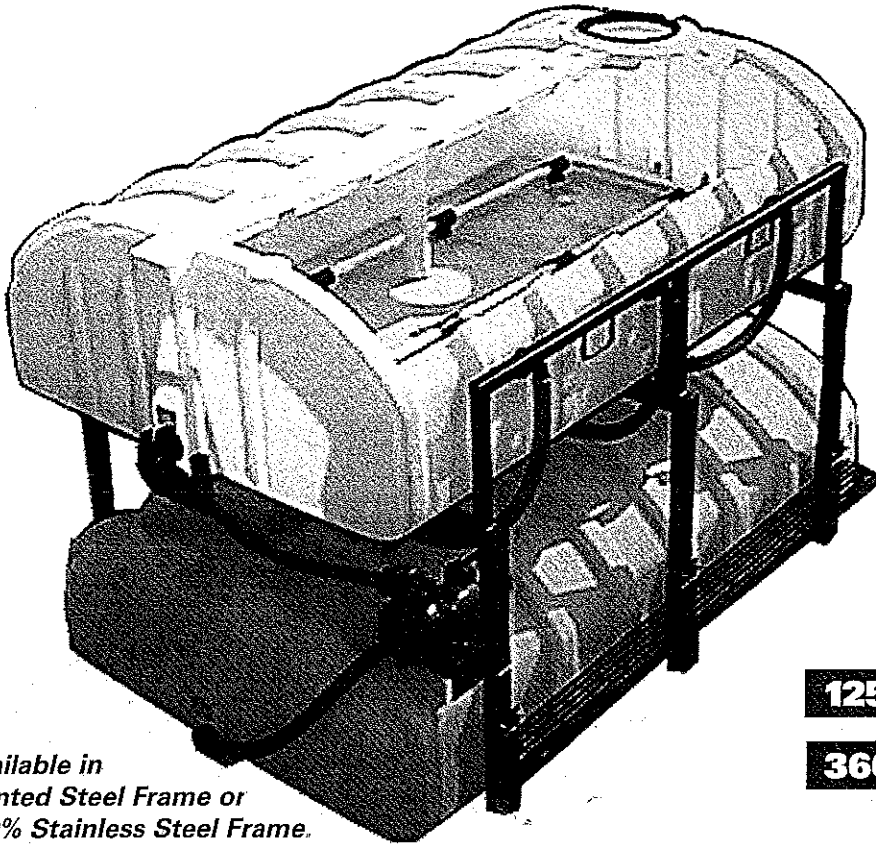

Available in
Painted Steel Frame or
100% Stainless Steel Frame.

● SB-1400

The SB-1400 manifold disperses water flow evenly throughout brine salt tank. It has been plumbed for easy recycling of brine solution back to salt holding tank. Completely adjustable height pump & walkway assemblies. Simple mechanical float - rated at 60 gpm @ 40 psi.

Available with 100 gpm pump (standard) or 150 gpm pump (optional). 115 or 230 volts available.

1250 Gallon Storage Capacity

3600+ Gallons Production/Hour

SB1400
Optional Stainless
Steel Pump

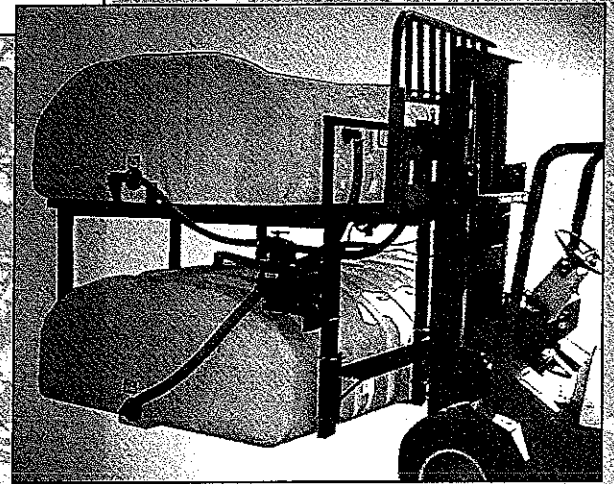
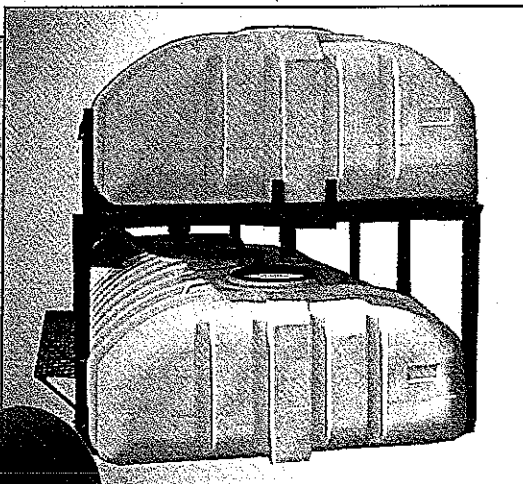
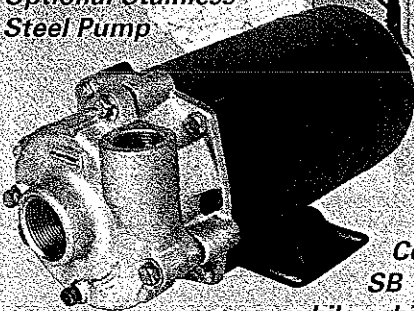

Heavy-Duty
Forklift Frame

Compared to similar systems - the Sprayer Specialties' SB 1400 takes little floor space (11'W x 7'D x 6'H), while achieving greater capacities!

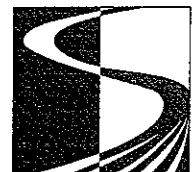

**SPRAYER
SPECIALTIES, INC.**

5149 N.W. 111th Drive
Capitol City Industrial Park
Des Moines, Iowa 50111



For More Information

PHONE: 515 · 986 · 3259 or Toll Free: 1 · 800 · 351 · 1587

FAX: 515 · 986 · 9257

"QUICK CLEAN" SALT BRINE SYSTEM

Patent Pending

100% Stainless Steel Frame, Tank and Hopper

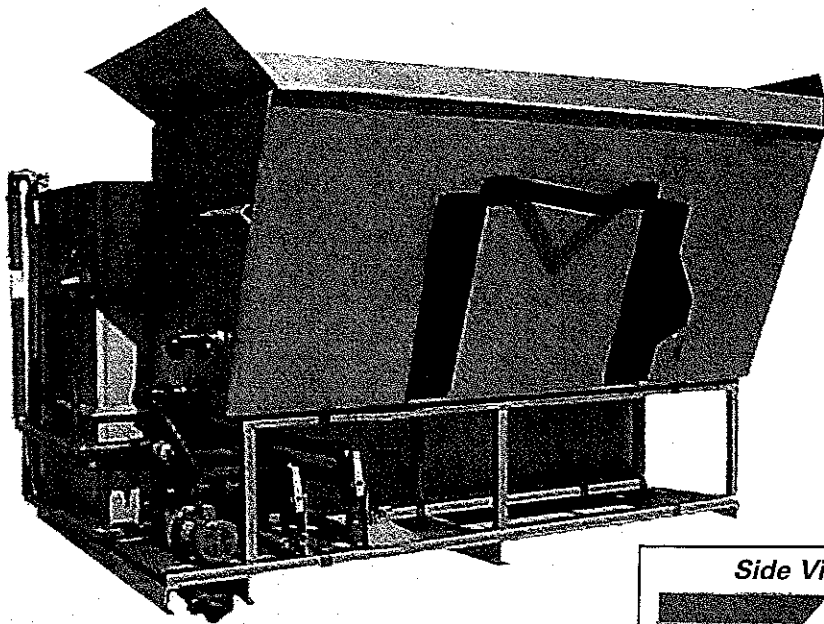

High Speed - 3600 GPH+

High Capacity - 1400 Gal. Storage

Easy Clean, Quick Dump Hopper

Side View

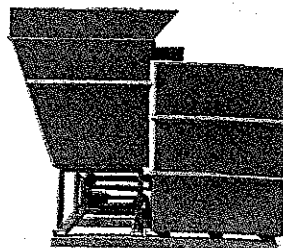

SB1400-SSEC

The innovative SB1400-SSEC Brine Making System is not just another brine maker. We know how to make brine. We're just taking it to the next level. Clean-out is an issue with all brine makers. Durability is the other. Both problems solved....

The SB1400-SSEC is the answer! Quick dumping system means no more painful hours of shoveling salt hopper residue! 100% stainless steel construction will keep the tank, hopper & frame components rust & corrosion at a minimum for decades!



Large Hopper: Easy dumping with minimal overspill.

*When "clean-out" time arrives...
Simplicity & Speed
are the Answers!*

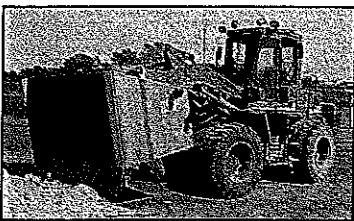
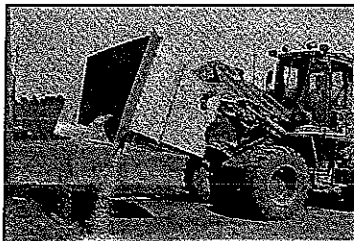

*Hook On
and
Dump Out
Only the
removal
of one
2" quick
coupler is
required
before
removing
hopper!*

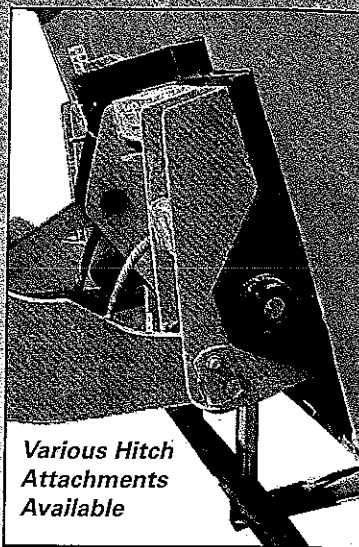

*Various Hitch
Attachments
Available*

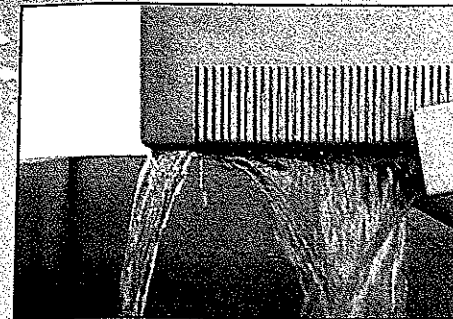

*Integrated, Laser Cut, Stainless
Steel Screening System*



For More Information CALL Toll Free 1-800-351-1587 or FAX to 515-986-9257

STORAGE

NORWESCO

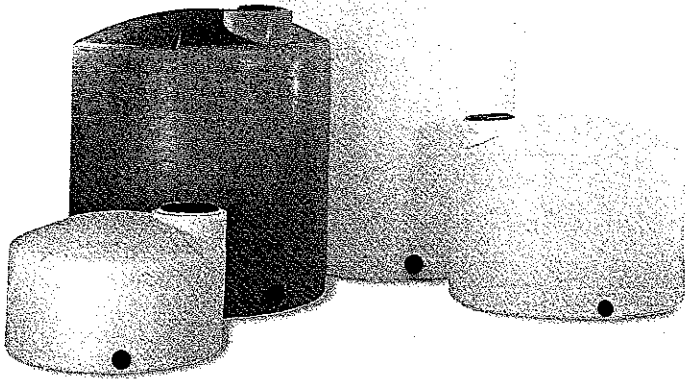

Vertical Storage Tanks

NORWESCO tanks are manufactured to strict quality guidelines to ensure years of high performance use. Rugged, impact-resistant, one-piece seamless polyethylene construction makes these tanks suitable for the storage and/or transport of most de-icing liquids as well as a wide range of industrial chemicals. NORWESCO tanks are manufactured using resins that meet FDA specifications to ensure safe storage of potable water. Quality, price, product line and leading edge technology make NORWESCO North

America's largest manufacturer of rotationally molded tanks. Vertical storage tanks are most frequently used for bulk storage and mobile nursing applications. NORWESCO vertical tanks feature tie-down sides, built-in graduated-gallonage indicators, and offset fill-well and a self-vented, splash-proof lid. All NORWESCO vertical tanks are equipped with an outlet fitting and siphon tube. All tanks listed below can be custom designed with poly or stainless steel fittings to your specs.

Gallon Capacity	Diameter	Height	Fill Opening	Outlet/Drain Specification	Premium Weight Part No White	Heavy Weight Part No Blue	Gallon Capacity	Diameter	Height	Fill Opening	Outlet/Drain Specification	Premium Weight Part No White	Heavy Weight Part No Blue
65 ∞	23"	42"	8"	1 1/4"	60213	-	2500	95"	89"	8"	2"	40051	40052
100	23"	63"	8"	2"	40803	-	3000	95"	107"	16"	2"	40754	40755
165	31"	55"	16"	2"	40281	-	3000	95"	107"	16"	3 1/2"	40063	40065
300	36"	78"	16"	2"	40213	-	4000	102"	125"	16"	3 1/2"	40312	-
305	46"	49"	16"	2"	40302	-	5000	102"	152"	16"	3 1/2"	40164	40166
500	48"	72"	16"	2"	40148	40150	5800	141"	97"	16"	3 1/2"	40071	-
550	67"	42"	16"	2"	40023	-	6000	102"	182"	16"	3 1/2"	40226	40233
750	48"	102"	16"	2"	40606	-	6100	120"	139"	16"	3 1/2"	40659	40661
1000	64"	79"	16"	2"	40152	40154	6500	120"	150"	16"	3 1/2"	40224	40232
1100	87"	51"	16"	2"	40070	40081	7800	120"	176"	16"	3 1/2"	40663	-
1500	64"	115"	16"	2"	40144	40146	9000	141"	146"	16"	3 1/2"	40543	40231
1550	87"	65"	16"	2"	40235	40236	10000	141"	160"	16"	3 1/2"	40545	40353
1700	87"	72"	16"	2"	40010	40012	12000	141"	192"	16"	3 *	40539	40541
2100	87"	87"	8"	2"	40178	40241	∞ Within UPS dimensional limits						
							* 316 Stainless Steel Bolted Fitting						

Sprayer Specialties stocks over 100 sizes and styles of tanks.

Tanks can be easily fitted to your exact specifications.

Other sizes and styles are available. Call for FOB points and availability.



**SPRAYER
SPECIALTIES,
INC.**

1-800-351-1587

... ON THE DRAWING BOARD

WE ARE CONSTANTLY ADDING TO OUR LIST OF STOCK TANKS. PLEASE CALL IF YOU HAVE A SPECIFIC NEED.

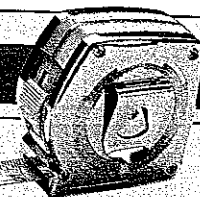

Complete Systems with Tanks

Built to your exact specifications Installation is available

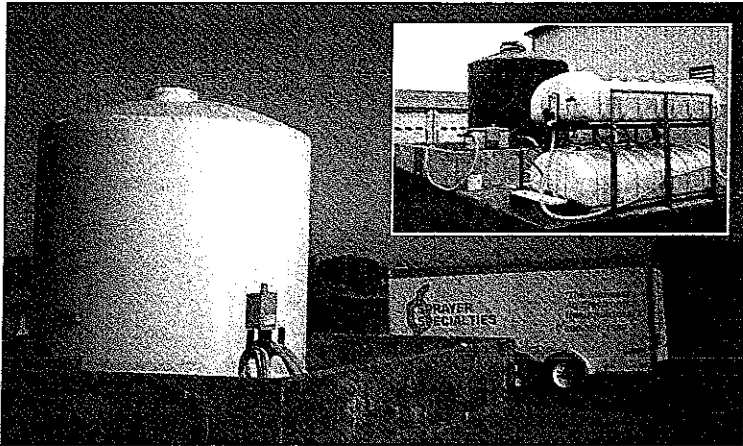

Same Day Shipping!

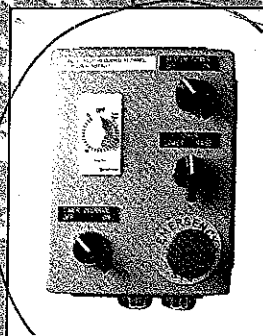
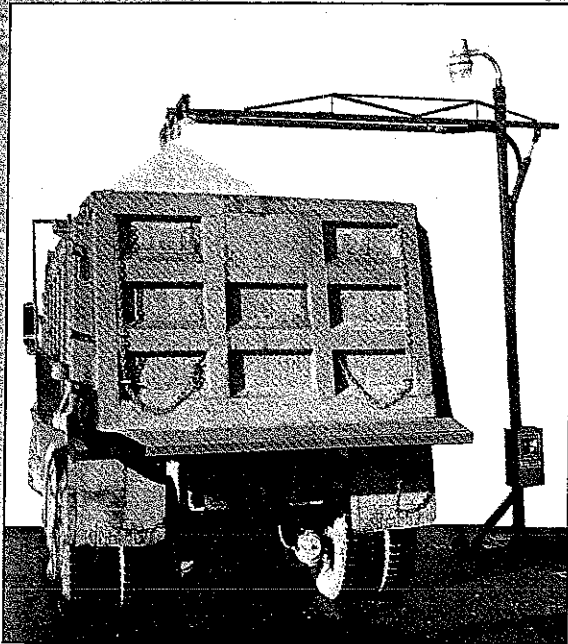

Overtruck Applications

Controlled by Remote location via 6-wire cable Control head functions:

- **System Power** - Powers all functions and activates light on tower.
- **Pump-on** will override timer, for loading applications.
- **Timers** available from 30-seconds to 30-minutes.
- **Tower Raise and Lower** via hydraulics mounted on tower.

- **Nozzles** - Various gallonage nozzles available.
- **Stainless Steel** application bar.
- **Finishes** - Available in epoxy painted or galvanized finishes.
- **Customized Application controls & Towers Available To Specifications.**

For More Information CALL Toll Free 1-800-351-1587 or FAX to 515-986-9257

ON THE DRAWING BOARD

AUTOMATED BRIDGE DECK APPLICATION SYSTEMS PRE-PROGRAMMED TO APPLY DE-ICING TO BRIDGE UNDER PROGRAMMED WEATHER CONDITIONS.



Fill Stations

Simple, Heavy-Duty and Built to Last!

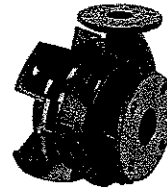

High Performance Pump Systems to your Specifications

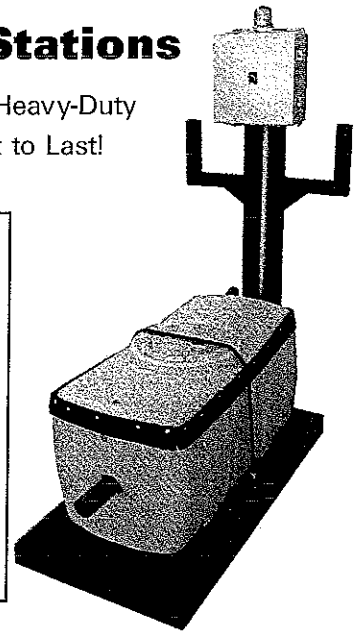

SPRAYER SPECIALTIES, INC.

5149 N.W. 111th Drive
Capitol City Industrial Park
Grimes, Iowa 50111

APPLICATIONS

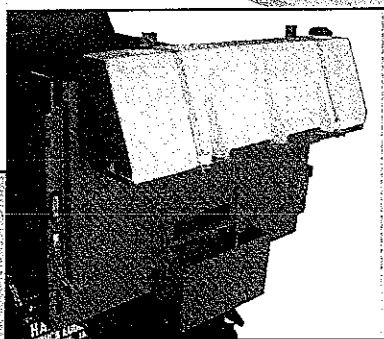
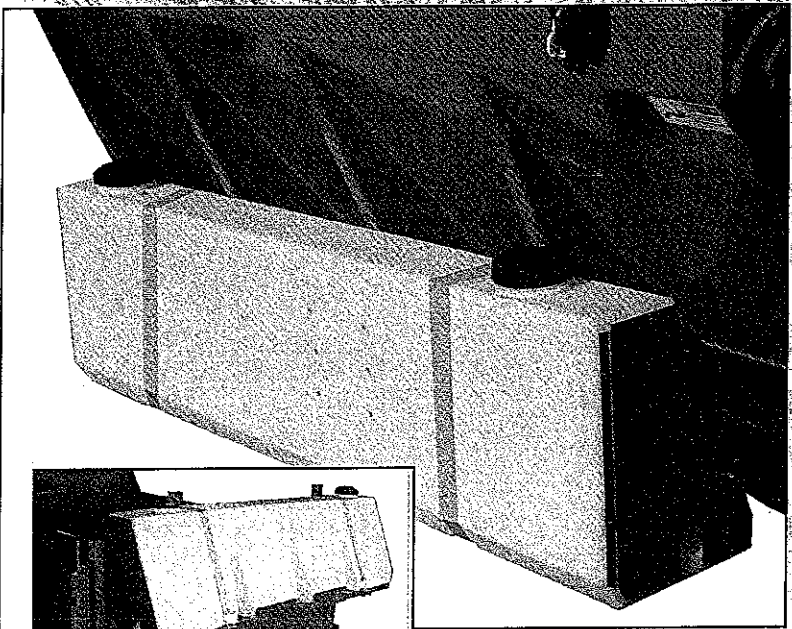
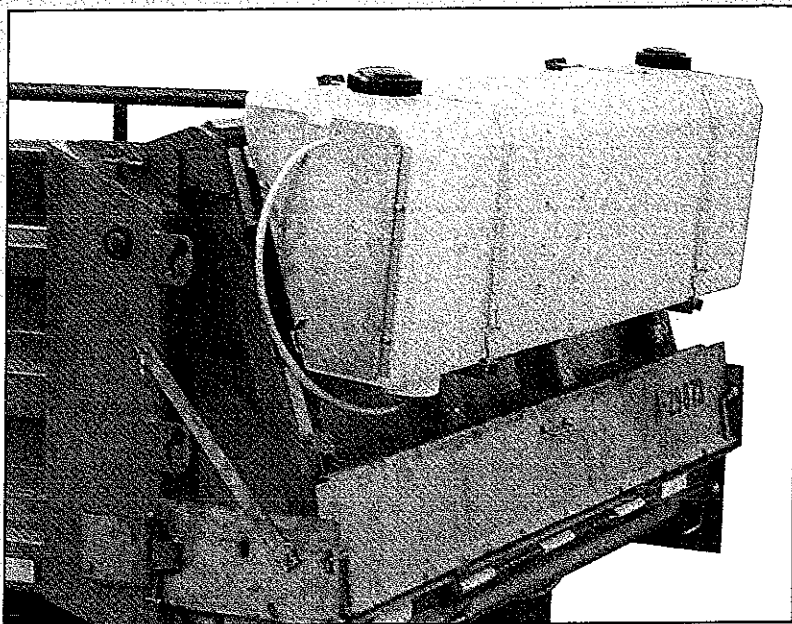

*Versatility -
Sander box VB100S
can also be adapted
to tailgate mount.*

● VB 100R

The VB 100R is a 100 gallon tank designed as a tailgate mounted prewet unit.

Integrated housing with stainless steel door and hinge combine for extended pump and control life.

Extreme wall thickness combined with heavy duty mounting frame provides for long tank life.

- All tanks & frames are made to strict standards for strength and durability.

- All tanks are covered by a complete 3-year warranty.

● VB 100S

The VB 100S is made with the same rigid specifications as the VB100R, with lid placement changed to what is not the top of the tank.

When equipment changes are made we also provide a rear mounting kit for the VB100S, giving versatility without the purchase of a complete system. (See "Mounting Kits" photo and explanation on page seven)

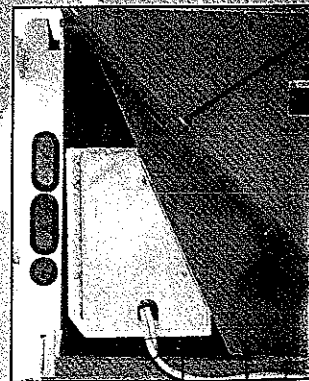

ON THE
DRAWING BOARD

IN-BOX PRE-WETTING TANKS FOR HIGHER
PRE-WETTING CAPACITIES...

APPLICATIONS

TRUCK MOUNTED PREWET TANKS

Standard Features

Standard features beyond the call of duty

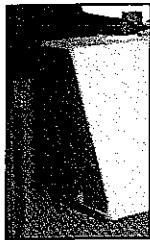

Weather resistant stainless steel door, hinge & thumb screw assembly

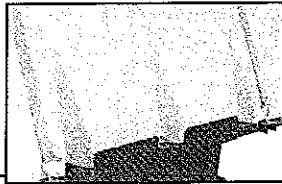

Dual 5" lids for easy filling access.



Three very deep baffles provide for minimum slosh.

Deep sump on VT100R provides for complete drainage.

Corrosion resistant 10,000 lb., nylon straps hold tank securely in place.



Specifications

Tank Dimensions

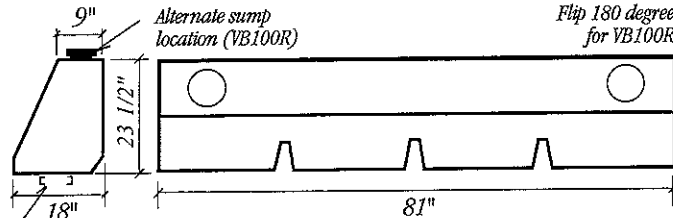

Shown: VB100S
Flip 180 degree
for VB100R

Materials:

Tank - High Density Polyethylene
Tank Fittings - Polypropylene
Door/Hinge/Hardware - Stainless Steel
Lids - Polypropylene

Mounting Kits

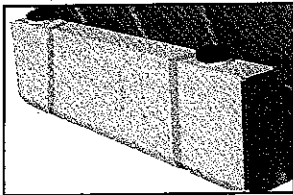

VB100S-MK1-S
Standard Mounting kit for side-of-sander mounting of VB100S tank.

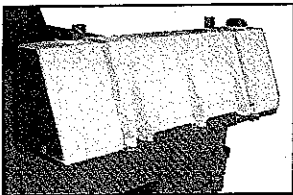

VB100S-MK2-R
Mounting kit for using VB100S (side-of-sander) as a rear mounted tank.

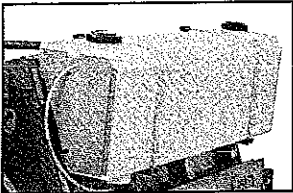

VB100R-MK1-R
Standard mounting kit for tailgate mounting using VB100R tank.



Same Day Shipping!



SPRAYER SPECIALTIES, INC.

5149 N.W. 111th Drive
Capitol City Industrial Park
Des Moines, Iowa 50111

Pumps & Controls

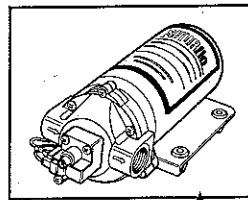

8000 Series Diaphragm Pump

Specifications:
12 volt DC,
5.0 amps, 1.4 gpm, 65
max. psi

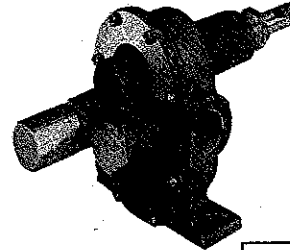

2088 Series Diaphragm Pump

Specifications:
12 volt DC
10.0 amps, 3.5 gpm,
45 max. psi

Hydraulic Driven Gear Pump

Specifications:
12 volt DC
10.0 amps, 3.5 gpm, 45
max. psi

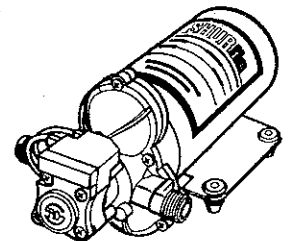

12 Volt Piston Pump

Manufactured due to the advent of heavier, less viscous ice control products. Various models available.

Specifications: 12 volt DC, 18.0
amps, 4.0 gpm, 100 max. psi

Pump Motor Speed Controller

for 12 volt Hydraulic systems

Controls liquid output & is available with optional low-tank-level indicator lights.

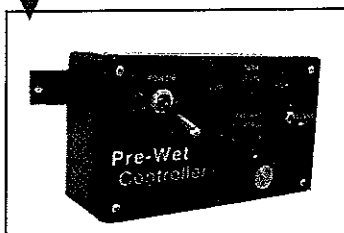

Proportional Monitor DCS300



Liquid flow is proportional to granular flow rate. Also displays tank volume

APPLICATIONS

DI 125, 225, 325 & *525 ●

Utilizing NORWESCO leg tanks.

*525 for flat beds only.

- For limited lane-mile and parking lot applications
- Custom built to your specifications.

PVC Booms economize the overall cost of these units while providing a low cost alternative to optional stainless booms.

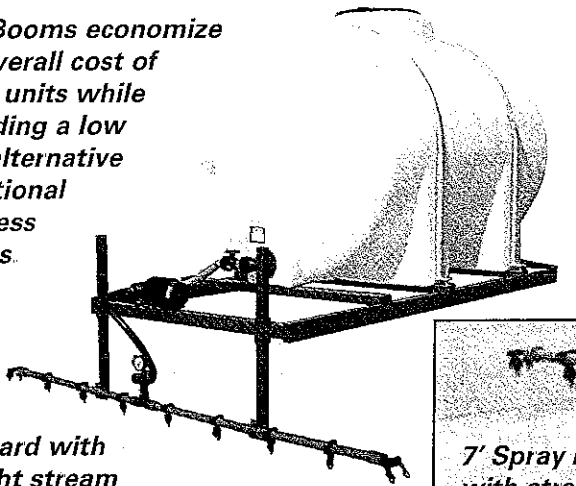

Standard with straight stream application nozzles.

DI525 Gal with spray boom.

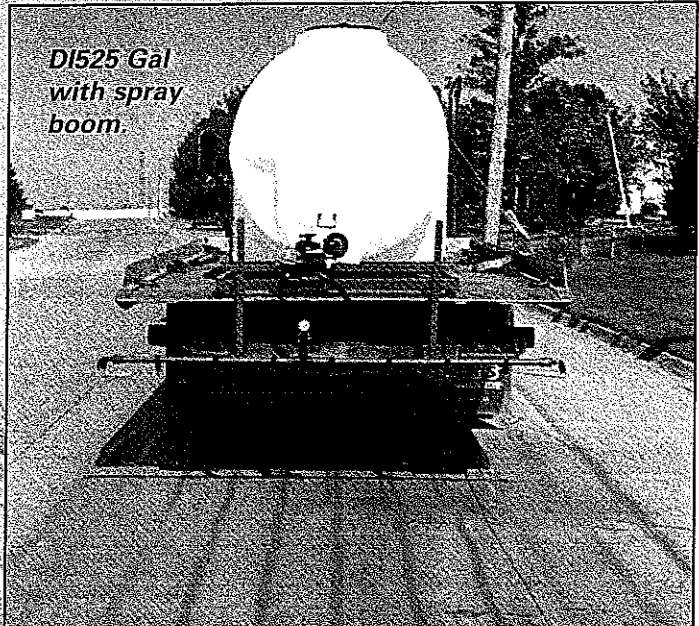

7' Spray bars with straight stream nozzles can provide up to 12' of coverage.

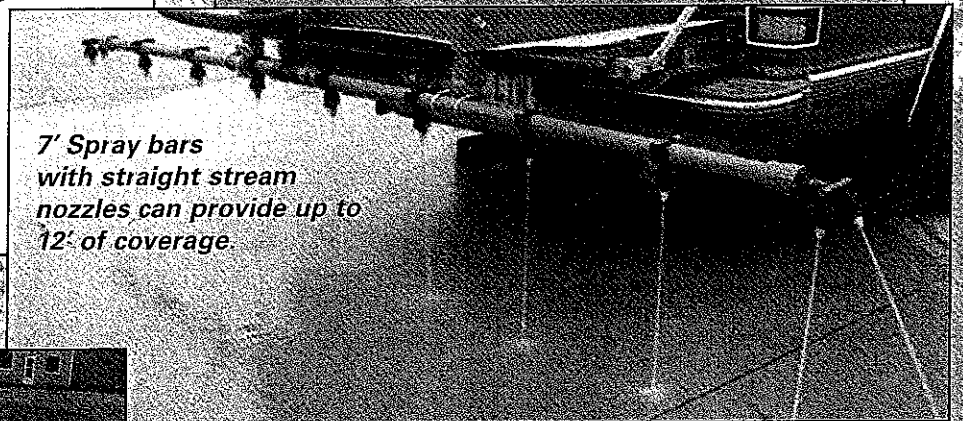

DI225 gal with PVC boom.

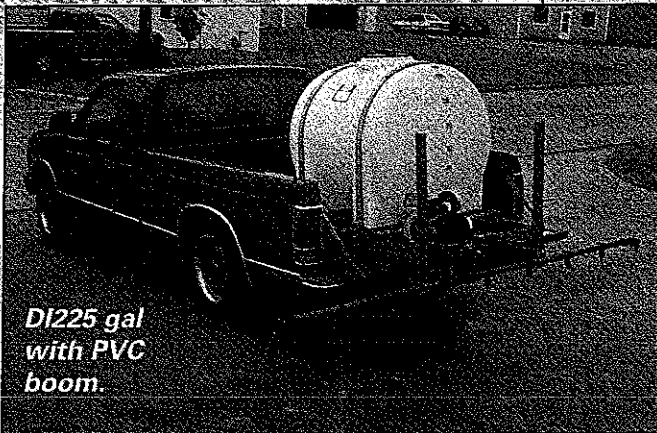

Standard with electric ball valves.

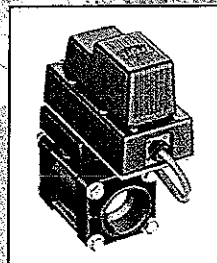

Economy anti-icing and de-icing units are standard equipped with HONDA engine-driven centrifugal pumps for maximum flow and pressure control.

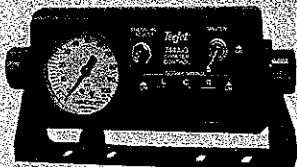
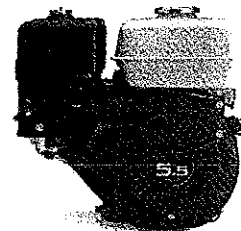

744 Standard Electric Controls.

Monitor Options

TeeJet - 834



TeeJet - 844

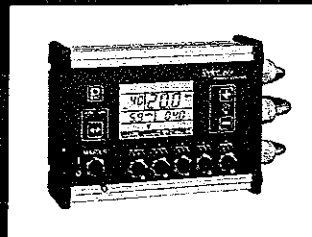

Raven 440

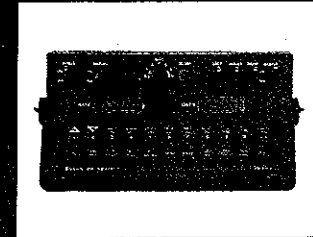

APPLICATIONS

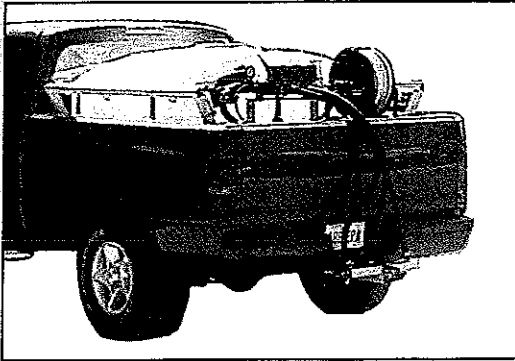

Full Speed Range.
Full Application Range.

3 lane/36' Coverage

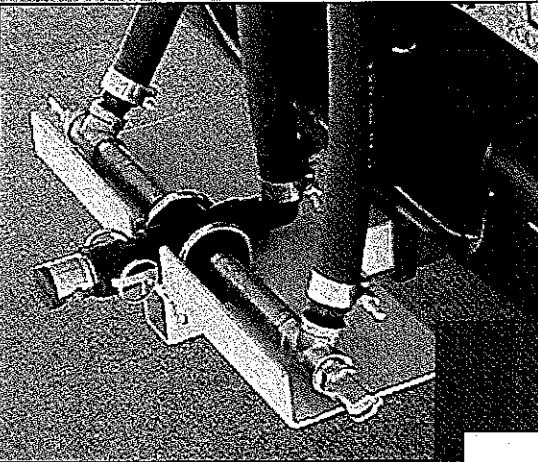

Boomless Nozzles
Great for Municipalities
and Parking Lot Maintenance

DI300 Anti-icing Unit

Easy-Loading Skid Units with Easy-Attach Booms

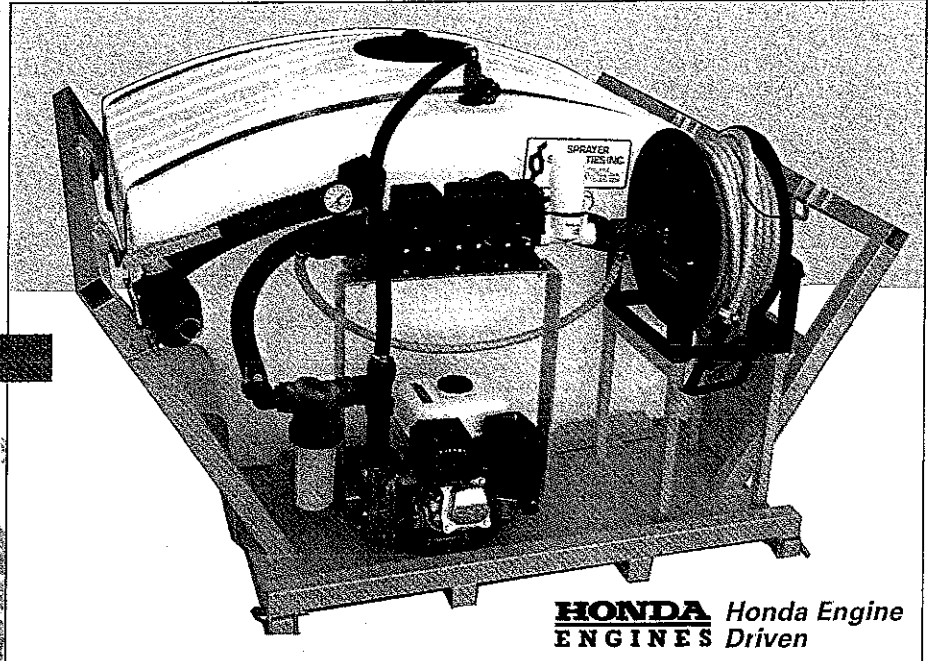

HONDA Honda Engine
ENGINES Driven

Boom Assembly Fits Standard Hitch Receiver

Monitor Options

TeeJet - 834

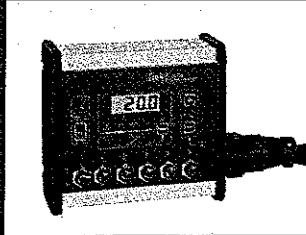

TeeJet - 844

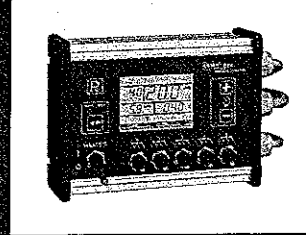

Raven 440

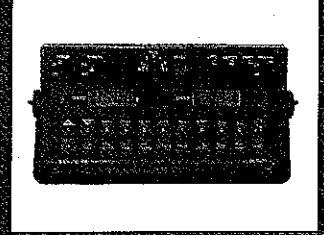

**SPRAYER
SPECIALTIES, INC.**

5149 N.W. 111th Drive
Capitol City Industrial Park
Des Moines, Iowa 50111



Same Day Shipping!

For More Information Call Toll Free
1-800-351-1587 or FAX
515-986-9257

ON THE DRAWING BOARD

PORTABLE & WALL HUNG DE-ICERS AND BRINE MAKERS FOR CONVENIENCE STORES, SMALL BUSINESS USES, TO KEEP SIDEWALKS AND DRIVEWAYS CLEAR.

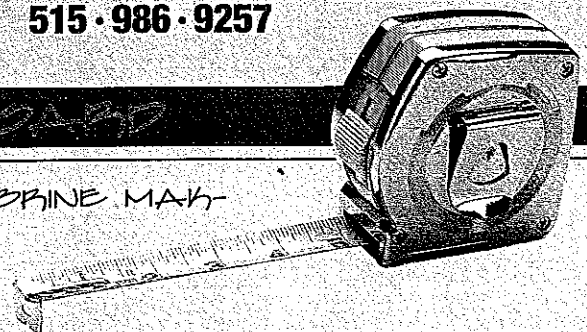

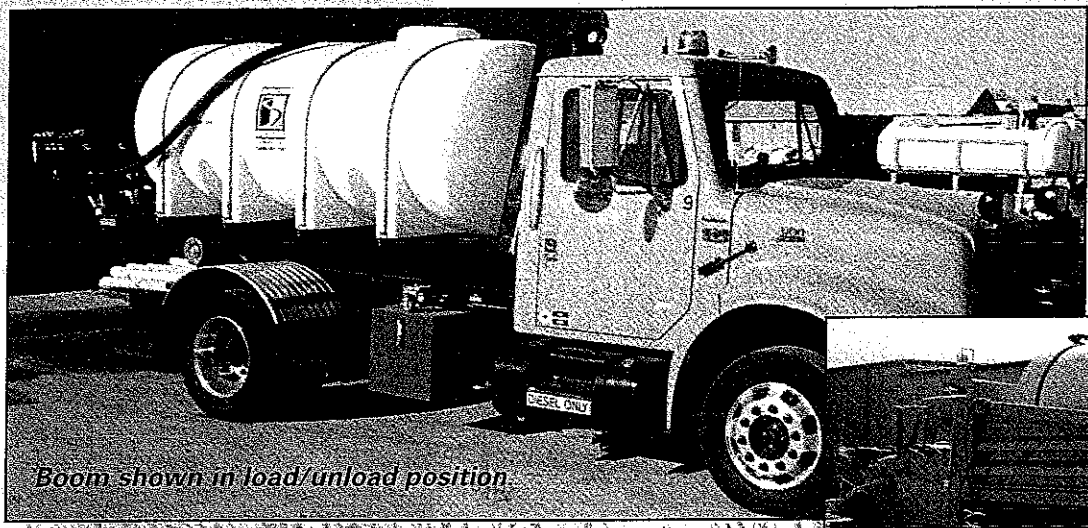

DI 925 with drive under frame and dual stage boom.

Boom shown in load/unload position

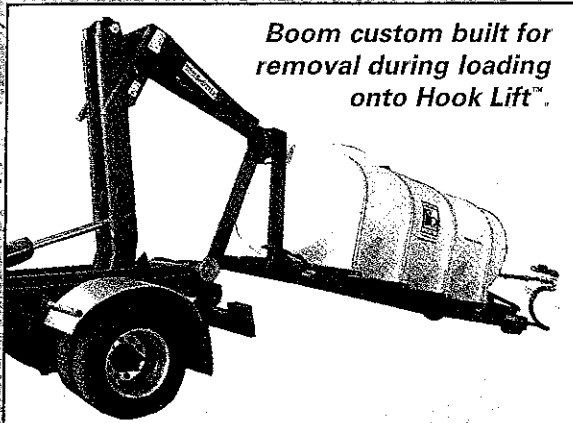
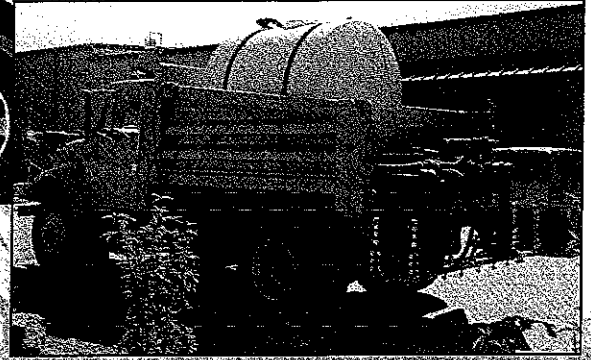

Boom custom built for removal during loading onto Hook Lift™.

CUSTOMIZE

Sprayer Specialties can build to your order like this 1,235 Gallon unit. Built on a Hook Lift™ Frame.

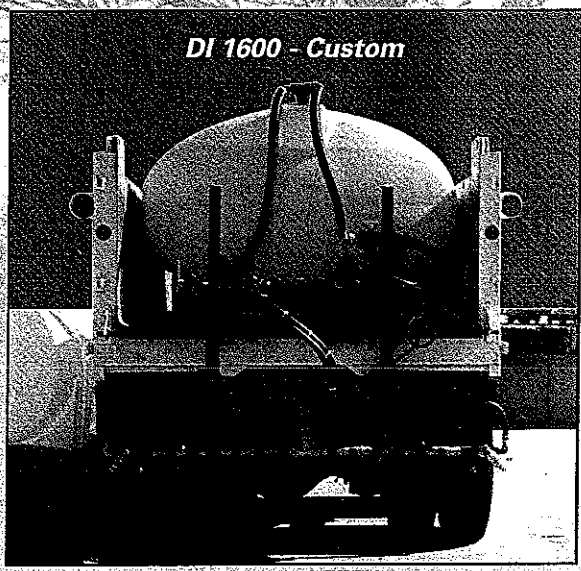

DI 1600 - Custom

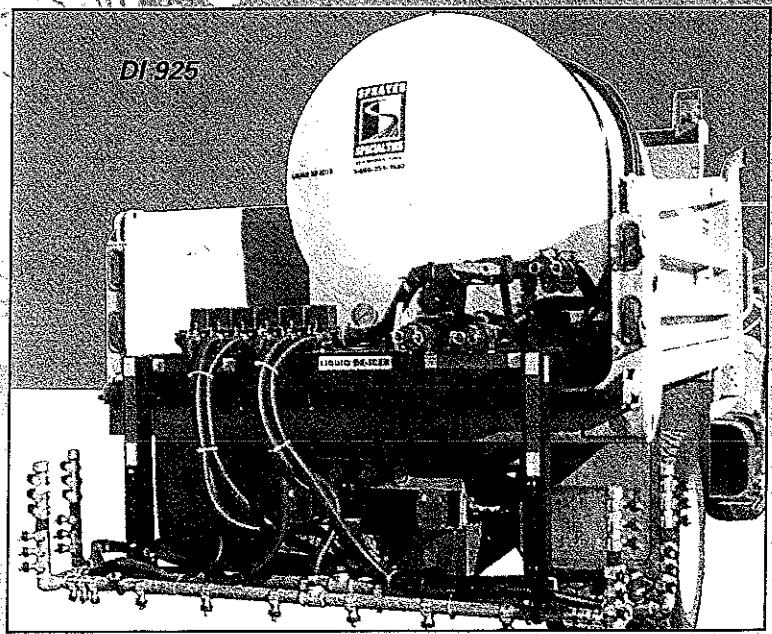

DI 925

... ON THE DRAWING BOARD

THE DRAWING BOARD IS ALWAYS READY TO DESIGN CUSTOMIZED SHED UNITS. LET US KNOW YOUR SPECIFICATIONS AND REQUIREMENTS.

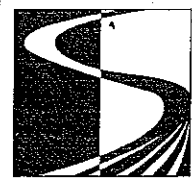
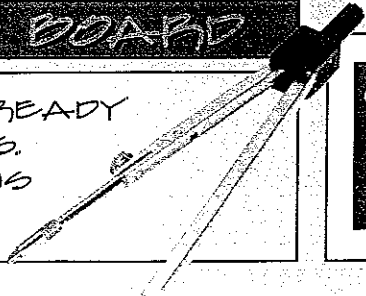

SPRAYER SPECIALTIES, INC.
5149 N.W. 111th Drive
Capitol City Industrial Park
Des Moines, Iowa 50111

APPLICATIONS

DI1800 Anti-icing Unit

Easy-Loading Drive Under Frames

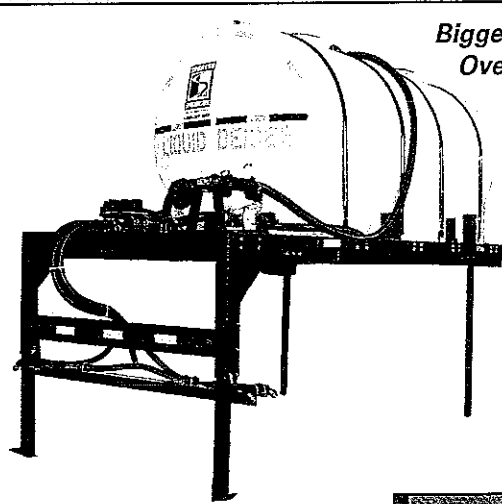
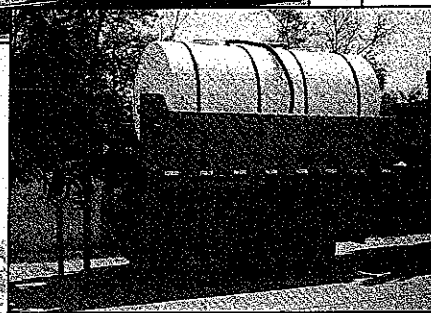

*Bigger Standard Frame
Overall Dimensions:*

Length: 174"
Width: 83"
Tank Width: 62"
Tank Length: 140"
Roller Height: 54"
Adjustable Boom Height

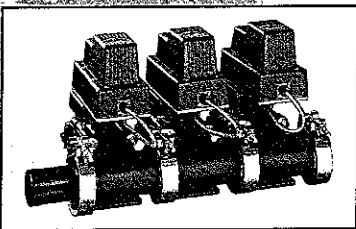

TeeJet Electric Ball Valves

- Premanufactured
- Extremely Fast
- Low Maintenance
- Dependable
- Standard on all DI 1800 units

Straight Stream Boom

For better control at all speeds

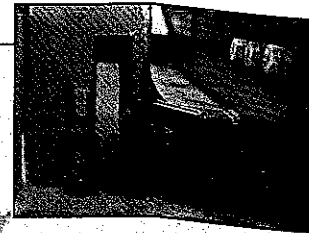
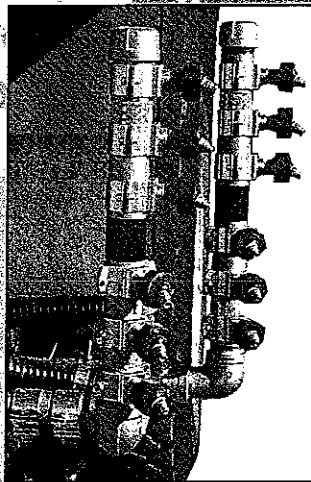

DI 1800 locks into truck box.

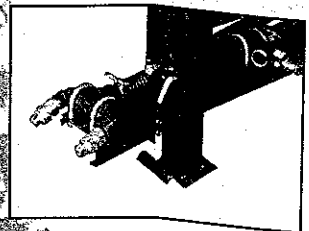

Large Fan Nozzles

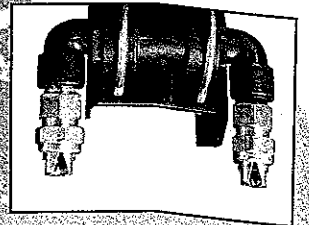

Optional Dual Stage Boom & Dual Stage Controller available.

TeeJet

834 - TeeJet Pressure based

TeeJet - 844 Flow based

DCS400

- Optional Dual Stage Boom Control
- Ice control on road beds
- Airport ice control
- Blast button option

Please Inquire about more information on Monitor Options.

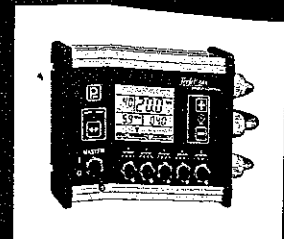
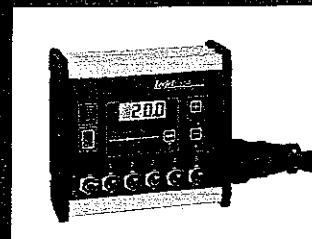

SPRAYER SPECIALTIES, INC.

Sales & Distribution Facility in Des Moines, Iowa

Sprayer Specialties, Inc. has a large inventory of new replacement parts for your de-icing and anti-icing equipment located in our warehouse distribution facility in Grimes, Iowa.

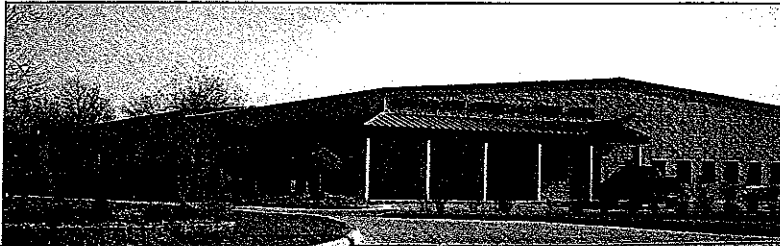

SPRAYER SPECIALTIES, INC.

5149 N.W. 111th Drive
Capitol City Industrial Park
Grimes, Iowa 50111

For More Information
CALL Toll Free 1-800-351-1587
or FAX to 515-986-9257



Call today
for your **FREE**
Comprehensive Parts Guide.

1-800-351-1587

www.sprayers.com

email: cccc111@aol.com