



Department of Administration
 Purchasing Division
 2019 Washington Street East
 Post Office Box 50130
 Charleston, WV 25305-0130

State of West Virginia Purchase Order

Order Date: 09-23-2022

CORRECT ORDER NUMBER MUST APPEAR
 ON ALL PACKAGES, INVOICES, AND
 SHIPPING PAPERS. QUESTIONS
 CONCERNING THIS ORDER SHOULD BE
 DIRECTED TO THE DEPARTMENT
 CONTACT.

Order Number:	CPO 0603 0603 ADJ2300000014 1	Procurement Folder:	1089036
Document Name:	Williamstown AASF#1 Taxiway & Apron Repairs (Construction)	Reason for Modification:	
Document Description:	Williamstown AASF#1 Taxiway & Apron Repairs (Construction)		
Procurement Type:	Central Purchase Order		
Buyer Name:	David H Pauline		
Telephone:	304-558-0067		
Email:	david.h.pauline@wv.gov		
Shipping Method:	Best Way	Effective Start Date:	
Free on Board:	FOB Dest, Freight Prepaid	Effective End Date:	

VENDOR		DEPARTMENT CONTACT		
Vendor Customer Code:	000000164510	Requestor Name:	Timothy D Hersman	
WOLF CREEK CONTRACTING CO LLC 403 WATERTOWN ROAD		Requestor Phone:	(304) 561-6453	
WATERFORD OH 45786		Requestor Email:	timothy.d.hersman.nfg@army.mil	
US		<div style="font-size: 48pt; font-weight: bold;">23</div> <div style="font-weight: bold;">FILE LOCATION</div>		
Vendor Contact Phone:	740-749-5818			Extension:
Discount Details:				
Discount Allowed	Discount Percentage			Discount Days
#1 No	0.0000			0
#2	Not Entered			
#3	Not Entered			
#4	Not Entered			

INVOICE TO	SHIP TO
DIVISION ENGINEERING & FACILITIES ADJUTANT GENERALS OFFICE 1707 COONSKIN DR	BUILDING TRADE SPECIALIST ARMY AVIATION SUPPORT FACILITY 1 387 AVIATION DR
CHARLESTON WV 25311	WILLIAMSTOWN WV 26187
US	US

Purchasing Division's File Copy

Total Order Amount:	\$1,198,255.00
----------------------------	----------------

ENTERED

PURCHASING DIVISION AUTHORIZATION DATE: <i>9/23/2022</i> ELECTRONIC SIGNATURE ON FILE: <i>[Signature]</i>	ATTORNEY GENERAL APPROVAL AS TO FORM DATE: <i>9/27/2022</i> ELECTRONIC SIGNATURE ON FILE: <i>[Signature]</i>	ENCUMBRANCE CERTIFICATION DATE: <i>9-27-22</i> ELECTRONIC SIGNATURE ON FILE: <i>[Signature]</i>
--	---	--

Extended Description:

Construction Contract
(Williamstown AASF#1 Taxiway & Apron Repairs)

The Vendor, Wolf Creek Contracting Company, LLC., agrees to enter into this one-time construction contract with the Agency, West Virginia Army National Guard, Construction and Facilities Management Office, to provide all labor, material, tools, equipment, supplies and supervision necessary to complete the Williamstown AASF#1 Taxiway & Apron Repairs, at the Army Aviation Support Facility #1, near Williamstown WV, per the bid requirements, terms, conditions, specifications, Addendum No. 1 issued 08/19/2022, Addendum No. 2 issued 08/29/2022 and the AIA A201-2017 WV Supplemental Conditions, and the vendor's bid dated 09/01/2022 all incorporated herein by reference and made apart of hereof.

Line	Commodity Code	Quantity	Unit	Unit Price	Total Price
1	72152700	0.00000		0.000000	932405.00
Service From	Service To	Manufacturer		Model No	

Commodity Line Description: Williamstown AASF#1 Taxiway & Apron Repairs (Construction)

Extended Description:

BASE BID (Per documentation)- Provide and furnish all labor, materials, tools, expendable equipment and all services to complete Williamstown AASF#1 Taxiway & Apron Repairs, near Williamstown WV per the attached specifications and documentation.

Line	Commodity Code	Quantity	Unit	Unit Price	Total Price
2	72152700	0.00000		0.000000	148250.00
Service From	Service To	Manufacturer		Model No	

Commodity Line Description: ADD-ALTERNATE 1- Per the Drawings & Specifications

Extended Description:

ADD- ALTERNATE NO.1(Per documentation)- Provide and furnish all labor, materials, tools, expendable equipment and all services to complete construction per Drawings and Specifications

Line	Commodity Code	Quantity	Unit	Unit Price	Total Price
3	72152700	0.00000		0.000000	57950.00
Service From	Service To	Manufacturer		Model No	

Commodity Line Description: ADD-ALTERNATE 2- Per the Drawings & Specifications

Extended Description:

ADD- ALTERNATE NO.2(Per documentation)- Provide and furnish all labor, materials, tools, expendable equipment and all services to complete construction per Drawings and Specifications

Line	Commodity Code	Quantity	Unit	Unit Price	Total Price
4	72152700	0.00000		0.000000	59650.00
Service From	Service To	Manufacturer		Model No	

Commodity Line Description: ADD-ALTERNATE 3- Per the Drawings & Specifications

Extended Description:

ADD- ALTERNATE NO. 3 (Per documentation)- Provide and furnish all labor, materials, tools, expendable equipment and all services to complete construction per Drawings and Specifications

	Document Phase	Document Description	Page
ADJ230000014	Draft	Williamstown AASF#1 Taxiway & Apron Repairs (Construction)	3

ADDITIONAL TERMS AND CONDITIONS

See attached document(s) for additional Terms and Conditions

GENERAL TERMS AND CONDITIONS:

1. CONTRACTUAL AGREEMENT: Issuance of an Award Document signed by the Purchasing Division Director, or his designee, and approved as to form by the Attorney General's office constitutes acceptance by the State of this Contract made by and between the State of West Virginia and the Vendor. Vendor's signature on its bid, or on the Contract if the Contract is not the result of a bid solicitation, signifies Vendor's agreement to be bound by and accept the terms and conditions contained in this Contract.

2. DEFINITIONS: As used in this Solicitation/Contract, the following terms shall have the meanings attributed to them below. Additional definitions may be found in the specifications included with this Solicitation/Contract.

2.1. "Agency" or "Agencies" means the agency, board, commission, or other entity of the State of West Virginia that is identified on the first page of the Solicitation or any other public entity seeking to procure goods or services under this Contract.

2.2. "Bid" or "Proposal" means the vendors submitted response to this solicitation.

2.3. "Contract" means the binding agreement that is entered into between the State and the Vendor to provide the goods or services requested in the Solicitation.

2.4. "Director" means the Director of the West Virginia Department of Administration, Purchasing Division.

2.5. "Purchasing Division" means the West Virginia Department of Administration, Purchasing Division.

2.6. "Award Document" means the document signed by the Agency and the Purchasing Division, and approved as to form by the Attorney General, that identifies the Vendor as the contract holder.

2.7. "Solicitation" means the official notice of an opportunity to supply the State with goods or services that is published by the Purchasing Division.

2.8. "State" means the State of West Virginia and/or any of its agencies, commissions, boards, etc. as context requires.

2.9. "Vendor" or "Vendors" means any entity submitting a bid in response to the Solicitation, the entity that has been selected as the lowest responsible bidder, or the entity that has been awarded the Contract as context requires.

3. CONTRACT TERM; RENEWAL; EXTENSION: The term of this Contract shall be determined in accordance with the category that has been identified as applicable to this Contract below:

Term Contract

Initial Contract Term: The Initial Contract Term will be for a period of _____ . The Initial Contract Term becomes effective on the effective start date listed on the first page of this Contract, identified as the State of West Virginia contract cover page containing the signatures of the Purchasing Division, Attorney General, and Encumbrance clerk (or another page identified as _____), and the Initial Contract Term ends on the effective end date also shown on the first page of this Contract.

Renewal Term: This Contract may be renewed upon the mutual written consent of the Agency, and the Vendor, with approval of the Purchasing Division and the Attorney General's office (Attorney General approval is as to form only). Any request for renewal should be delivered to the Agency and then submitted to the Purchasing Division thirty (30) days prior to the expiration date of the initial contract term or appropriate renewal term. A Contract renewal shall be in accordance with the terms and conditions of the original contract. Unless otherwise specified below, renewal of this Contract is limited to _____ successive one (1) year periods or multiple renewal periods of less than one year, provided that the multiple renewal periods do not exceed the total number of months available in all renewal years combined. Automatic renewal of this Contract is prohibited. Renewals must be approved by the Vendor, Agency, Purchasing Division and Attorney General's office (Attorney General approval is as to form only)

Alternate Renewal Term – This contract may be renewed for _____ successive _____ year periods or shorter periods provided that they do not exceed the total number of months contained in all available renewals. Automatic renewal of this Contract is prohibited. Renewals must be approved by the Vendor, Agency, Purchasing Division and Attorney General's office (Attorney General approval is as to form only)

Delivery Order Limitations: In the event that this contract permits delivery orders, a delivery order may only be issued during the time this Contract is in effect. Any delivery order issued within one year of the expiration of this Contract shall be effective for one year from the date the delivery order is issued. No delivery order may be extended beyond one year after this Contract has expired.

Fixed Period Contract: This Contract becomes effective upon Vendor's receipt of the notice to proceed and must be completed within One hundred eighty (180) calendar days.

Fixed Period Contract with Renewals: This Contract becomes effective upon Vendor's receipt of the notice to proceed and part of the Contract more fully described in the attached specifications must be completed within _____ days. Upon completion of the work covered by the preceding sentence, the vendor agrees that:

the contract will continue for _____ years;

the contract may be renewed for _____ successive _____ year periods or shorter periods provided that they do not exceed the total number of months contained in all available renewals. Automatic renewal of this Contract is prohibited. Renewals must be approved by the Vendor, Agency, Purchasing Division and Attorney General's Office (Attorney General approval is as to form only).

One-Time Purchase: The term of this Contract shall run from the issuance of the Award Document until all of the goods contracted for have been delivered, but in no event will this Contract extend for more than one fiscal year.

Construction/Project Oversight: This Contract becomes effective on the effective start date listed on the first page of this Contract, identified as the State of West Virginia contract cover page containing the signatures of the Purchasing Division, Attorney General, and Encumbrance clerk (or another page identified as _____), and continues until the project for which the vendor is providing oversight is complete.

Other: Contract Term specified in _____

4. AUTHORITY TO PROCEED: Vendor is authorized to begin performance of this contract on the date of encumbrance listed on the front page of the Award Document unless either the box for "Fixed Period Contract" or "Fixed Period Contract with Renewals" has been checked in Section 3 above. If either "Fixed Period Contract" or "Fixed Period Contract with Renewals" has been checked, Vendor must not begin work until it receives a separate notice to proceed from the State. The notice to proceed will then be incorporated into the Contract via change order to memorialize the official date that work commenced.

5. QUANTITIES: The quantities required under this Contract shall be determined in accordance with the category that has been identified as applicable to this Contract below.

Open End Contract: Quantities listed in this Solicitation/Award Document are approximations only, based on estimates supplied by the Agency. It is understood and agreed that the Contract shall cover the quantities actually ordered for delivery during the term of the Contract, whether more or less than the quantities shown.

Service: The scope of the service to be provided will be more clearly defined in the specifications included herewith.

Combined Service and Goods: The scope of the service and deliverable goods to be provided will be more clearly defined in the specifications included herewith.

One-Time Purchase: This Contract is for the purchase of a set quantity of goods that are identified in the specifications included herewith. Once those items have been delivered, no additional goods may be procured under this Contract without an appropriate change order approved by the Vendor, Agency, Purchasing Division, and Attorney General's office.

6. EMERGENCY PURCHASES: The Purchasing Division Director may authorize the Agency to purchase goods or services in the open market that Vendor would otherwise provide under this Contract if those goods or services are for immediate or expedited delivery in an emergency. Emergencies shall include, but are not limited to, delays in transportation or an unanticipated increase in the volume of work. An emergency purchase in the open market, approved by the Purchasing Division Director, shall not constitute a breach of this Contract and shall not entitle the Vendor to any form of compensation or damages. This provision does not excuse the State from fulfilling its obligations under a One-Time Purchase contract.

7. REQUIRED DOCUMENTS: All of the items checked in this section must be provided to the Purchasing Division by the Vendor as specified:

BID BOND (Construction Only): Pursuant to the requirements contained in W. Va. Code § 5-22-1(c), All Vendors submitting a bid on a construction project shall furnish a valid bid bond in the amount of five percent (5%) of the total amount of the bid protecting the State of West Virginia. The bid bond must be submitted with the bid.

PERFORMANCE BOND: The apparent successful Vendor shall provide a performance bond in the amount of 100% of the contract. The performance bond must be received by the Purchasing Division prior to Contract award.

LABOR/MATERIAL PAYMENT BOND: The apparent successful Vendor shall provide a labor/material payment bond in the amount of 100% of the Contract value. The labor/material payment bond must be delivered to the Purchasing Division prior to Contract award.

In lieu of the Bid Bond, Performance Bond, and Labor/Material Payment Bond, the Vendor may provide certified checks, cashier's checks, or irrevocable letters of credit. Any certified check, cashier's check, or irrevocable letter of credit provided in lieu of a bond must be of the same amount and delivered on the same schedule as the bond it replaces. A letter of credit submitted in lieu of a performance and labor/material payment bond will only be allowed for projects under \$100,000. Personal or business checks are not acceptable. Notwithstanding the foregoing, West Virginia Code § 5-22-1 (d) mandates that a vendor provide a performance and labor/material payment bond for construction projects. Accordingly, substitutions for the performance and labor/material payment bonds for construction projects is not permitted.

MAINTENANCE BOND: The apparent successful Vendor shall provide a two (2) year maintenance bond covering the roofing system. The maintenance bond must be issued and delivered to the Purchasing Division prior to Contract award.

LICENSE(S) / CERTIFICATIONS / PERMITS: In addition to anything required under the Section of the General Terms and Conditions entitled Licensing, the apparent successful Vendor shall furnish proof of the following licenses, certifications, and/or permits upon request and in a form acceptable to the State. The request may be prior to or after contract award at the State's sole discretion.

West Virginia Contractor's license

The apparent successful Vendor shall also furnish proof of any additional licenses or certifications contained in the specifications regardless of whether or not that requirement is listed above.

8. INSURANCE: The apparent successful Vendor shall furnish proof of the insurance identified by a checkmark below and must include the State as an additional insured on each policy prior to Contract award. The insurance coverages identified below must be maintained throughout the life of this contract. Thirty (30) days prior to the expiration of the insurance policies, Vendor shall provide the Agency with proof that the insurance mandated herein has been continued. Vendor must also provide Agency with immediate notice of any changes in its insurance policies, including but not limited to, policy cancelation, policy reduction, or change in insurers. The apparent successful Vendor shall also furnish proof of any additional insurance requirements contained in the specifications prior to Contract award regardless of whether that insurance requirement is listed in this section.

Vendor must maintain:

Commercial General Liability Insurance in at least an amount of: \$1,000,000.00 per occurrence.

Automobile Liability Insurance in at least an amount of: \$1,000,000.00 per occurrence.

Professional/Malpractice/Errors and Omission Insurance in at least an amount of: _____ per occurrence. Notwithstanding the forgoing, Vendor's are not required to list the State as an additional insured for this type of policy.

Commercial Crime and Third Party Fidelity Insurance in an amount of: _____ per occurrence.

Cyber Liability Insurance in an amount of: _____ per occurrence.

Builders Risk Insurance in an amount equal to 100% of the amount of the Contract.

Pollution Insurance in an amount of: _____ per occurrence.

Aircraft Liability in an amount of: _____ per occurrence.

*****Please make Insurance Certificate Holder to Read***
West Virginia Army National Guard
1707 Coonskin Drive, Charleston, WV 25311**

Notwithstanding anything contained in this section to the contrary, the Director of the Purchasing Division reserves the right to waive the requirement that the State be named as an additional insured on one or more of the Vendor's insurance policies if the Director finds that doing so is in the State's best interest.

9. WORKERS' COMPENSATION INSURANCE: Vendor shall comply with laws relating to workers compensation, shall maintain workers' compensation insurance when required, and shall furnish proof of workers' compensation insurance upon request.

10. [Reserved]

11. LIQUIDATED DAMAGES: This clause shall in no way be considered exclusive and shall not limit the State or Agency's right to pursue any other available remedy. Vendor shall pay liquidated damages in the amount specified below or as described in the specifications:

_____ for _____.

Liquidated Damages Contained in the Specifications.

Liquidated Damages Are Not Included in this Contract.

12. ACCEPTANCE: Vendor's signature on its bid, or on the certification and signature page, constitutes an offer to the State that cannot be unilaterally withdrawn, signifies that the product or service proposed by vendor meets the mandatory requirements contained in the Solicitation for that product or service, unless otherwise indicated, and signifies acceptance of the terms and conditions contained in the Solicitation unless otherwise indicated.

13. PRICING: The pricing set forth herein is firm for the life of the Contract, unless specified elsewhere within this Solicitation/Contract by the State. A Vendor's inclusion of price adjustment provisions in its bid, without an express authorization from the State in the Solicitation to do so, may result in bid disqualification. Notwithstanding the foregoing, Vendor must extend any publicly advertised sale price to the State and invoice at the lower of the contract price or the publicly advertised sale price.

14. PAYMENT IN ARREARS: Payments for goods/services will be made in arrears only upon receipt of a proper invoice, detailing the goods/services provided or receipt of the goods/services, whichever is later. Notwithstanding the foregoing, payments for software maintenance, licenses, or subscriptions may be paid annually in advance.

15. PAYMENT METHODS: Vendor must accept payment by electronic funds transfer and P-Card. (The State of West Virginia's Purchasing Card program, administered under contract by a banking institution, processes payment for goods and services through state designated credit cards.)

16. TAXES: The Vendor shall pay any applicable sales, use, personal property or any other taxes arising out of this Contract and the transactions contemplated thereby. The State of West Virginia is exempt from federal and state taxes and will not pay or reimburse such taxes.

17. ADDITIONAL FEES: Vendor is not permitted to charge additional fees or assess additional charges that were not either expressly provided for in the solicitation published by the State of West Virginia, included in the Contract, or included in the unit price or lump sum bid amount that Vendor is required by the solicitation to provide. Including such fees or charges as notes to the solicitation may result in rejection of vendor's bid. Requesting such fees or charges be paid after the contract has been awarded may result in cancellation of the contract.

18. FUNDING: This Contract shall continue for the term stated herein, contingent upon funds being appropriated by the Legislature or otherwise being made available. In the event funds are not appropriated or otherwise made available, this Contract becomes void and of no effect beginning on July 1 of the fiscal year for which funding has not been appropriated or otherwise made available. If that occurs, the State may notify the Vendor that an alternative source of funding has been obtained and thereby avoid the automatic termination. Non-appropriation or non-funding shall not be considered an event of default.

19. CANCELLATION: The Purchasing Division Director reserves the right to cancel this Contract immediately upon written notice to the vendor if the materials or workmanship supplied do not conform to the specifications contained in the Contract. The Purchasing Division Director may also cancel any purchase or Contract upon 30 days written notice to the Vendor in accordance with West Virginia Code of State Rules § 148-1-5.2.b.

20. TIME: Time is of the essence regarding all matters of time and performance in this Contract.

21. APPLICABLE LAW: This Contract is governed by and interpreted under West Virginia law without giving effect to its choice of law principles. Any information provided in specification manuals, or any other source, verbal or written, which contradicts or violates the West Virginia Constitution, West Virginia Code, or West Virginia Code of State Rules is void and of no effect.

22. COMPLIANCE WITH LAWS: Vendor shall comply with all applicable federal, state, and local laws, regulations and ordinances. By submitting a bid, Vendor acknowledges that it has reviewed, understands, and will comply with all applicable laws, regulations, and ordinances.

SUBCONTRACTOR COMPLIANCE: Vendor shall notify all subcontractors providing commodities or services related to this Contract that as subcontractors, they too are required to comply with all applicable laws, regulations, and ordinances. Notification under this provision must occur prior to the performance of any work under the contract by the subcontractor.

23. ARBITRATION: Any references made to arbitration contained in this Contract, Vendor's bid, or in any American Institute of Architects documents pertaining to this Contract are hereby deleted, void, and of no effect.

24. MODIFICATIONS: This writing is the parties' final expression of intent. Notwithstanding anything contained in this Contract to the contrary no modification of this Contract shall be binding without mutual written consent of the Agency, and the Vendor, with approval of the Purchasing Division and the Attorney General's office (Attorney General approval is as to form only). Any change to existing contracts that adds work or changes contract cost, and were not included in the original contract, must be approved by the Purchasing Division and the Attorney General's Office (as to form) prior to the implementation of the change or commencement of work affected by the change.

25. WAIVER: The failure of either party to insist upon a strict performance of any of the terms or provision of this Contract, or to exercise any option, right, or remedy herein contained, shall not be construed as a waiver or a relinquishment for the future of such term, provision, option, right, or remedy, but the same shall continue in full force and effect. Any waiver must be expressly stated in writing and signed by the waiving party.

26. SUBSEQUENT FORMS: The terms and conditions contained in this Contract shall supersede any and all subsequent terms and conditions which may appear on any form documents submitted by Vendor to the Agency or Purchasing Division such as price lists, order forms, invoices, sales agreements, or maintenance agreements, and includes internet websites or other electronic documents. Acceptance or use of Vendor's forms does not constitute acceptance of the terms and conditions contained thereon.

27. ASSIGNMENT: Neither this Contract nor any monies due, or to become due hereunder, may be assigned by the Vendor without the express written consent of the Agency, the Purchasing Division, the Attorney General's office (as to form only), and any other government agency or office that may be required to approve such assignments.

28. WARRANTY: The Vendor expressly warrants that the goods and/or services covered by this Contract will: (a) conform to the specifications, drawings, samples, or other description furnished or specified by the Agency; (b) be merchantable and fit for the purpose intended; and (c) be free from defect in material and workmanship.

29. STATE EMPLOYEES: State employees are not permitted to utilize this Contract for personal use and the Vendor is prohibited from permitting or facilitating the same.

30. PRIVACY, SECURITY, AND CONFIDENTIALITY: The Vendor agrees that it will not disclose to anyone, directly or indirectly, any such personally identifiable information or other confidential information gained from the Agency, unless the individual who is the subject of the information consents to the disclosure in writing or the disclosure is made pursuant to the Agency's policies, procedures, and rules. Vendor further agrees to comply with the Confidentiality Policies and Information Security Accountability Requirements, set forth in <http://www.state.wv.us/admin/purchase/privacy/default.html>.

31. YOUR SUBMISSION IS A PUBLIC DOCUMENT: Vendor's entire response to the Solicitation and the resulting Contract are public documents. As public documents, they will be disclosed to the public following the bid/proposal opening or award of the contract, as required by the competitive bidding laws of West Virginia Code §§ 5A-3-1 et seq., 5-22-1 et seq., and 5G-1-1 et seq. and the Freedom of Information Act West Virginia Code §§ 29B-1-1 et seq.

DO NOT SUBMIT MATERIAL YOU CONSIDER TO BE CONFIDENTIAL, A TRADE SECRET, OR OTHERWISE NOT SUBJECT TO PUBLIC DISCLOSURE.

Submission of any bid, proposal, or other document to the Purchasing Division constitutes your explicit consent to the subsequent public disclosure of the bid, proposal, or document. The Purchasing Division will disclose any document labeled "confidential," "proprietary," "trade secret," "private," or labeled with any other claim against public disclosure of the documents, to include any "trade secrets" as defined by West Virginia Code § 47-22-1 et seq. All submissions are subject to public disclosure without notice.

32. LICENSING: In accordance with West Virginia Code of State Rules § 148-1-6.1.e, Vendor must be licensed and in good standing in accordance with any and all state and local laws and requirements by any state or local agency of West Virginia, including, but not limited to, the West Virginia Secretary of State's Office, the West Virginia Tax Department, West Virginia Insurance Commission, or any other state agency or political subdivision. Obligations related to political subdivisions may include, but are not limited to, business licensing, business and occupation taxes, inspection compliance, permitting, etc. Upon request, the Vendor must provide all necessary releases to obtain information to enable the Purchasing Division Director or the Agency to verify that the Vendor is licensed and in good standing with the above entities.

SUBCONTRACTOR COMPLIANCE: Vendor shall notify all subcontractors providing commodities or services related to this Contract that as subcontractors, they too are required to be licensed, in good standing, and up-to-date on all state and local obligations as described in this section. Obligations related to political subdivisions may include, but are not limited to, business licensing, business and occupation taxes, inspection compliance, permitting, etc. Notification under this provision must occur prior to the performance of any work under the contract by the subcontractor.

33. ANTITRUST: In submitting a bid to, signing a contract with, or accepting a Award Document from any agency of the State of West Virginia, the Vendor agrees to convey, sell, assign, or transfer to the State of West Virginia all rights, title, and interest in and to all causes of action it may now or hereafter acquire under the antitrust laws of the United States and the State of West Virginia for price fixing and/or unreasonable restraints of trade relating to the particular commodities or services purchased or acquired by the State of West Virginia. Such assignment shall be made and become effective at the time the purchasing agency tenders the initial payment to Vendor.

34. VENDOR CERTIFICATIONS: By signing its bid or entering into this Contract, Vendor certifies (1) that its bid or offer was made without prior understanding, agreement, or connection with any corporation, firm, limited liability company, partnership, person or entity submitting a bid or offer for the same material, supplies, equipment or services; (2) that its bid or offer is in all respects fair and without collusion or fraud; (3) that this Contract is accepted or entered into without any prior understanding, agreement, or connection to any other entity that could be considered a violation of law; and (4) that it has reviewed this Solicitation in its entirety; understands the requirements, terms and conditions, and other information contained herein.

Vendor's signature on its bid or offer also affirms that neither it nor its representatives have any interest, nor shall acquire any interest, direct or indirect, which would compromise the performance of its services hereunder. Any such interests shall be promptly presented in detail to the Agency. The individual signing this bid or offer on behalf of Vendor certifies that he or she is authorized by the Vendor to execute this bid or offer or any documents related thereto on Vendor's behalf; that he or she is authorized to bind the Vendor in a contractual relationship; and that, to the best of his or her knowledge, the Vendor has properly registered with any State agency that may require registration.

35. VENDOR RELATIONSHIP: The relationship of the Vendor to the State shall be that of an independent contractor and no principal-agent relationship or employer-employee relationship is contemplated or created by this Contract. The Vendor as an independent contractor is solely liable for the acts and omissions of its employees and agents. Vendor shall be responsible for selecting, supervising, and compensating any and all individuals employed pursuant to the terms of this Solicitation and resulting contract. Neither the Vendor, nor any employees or subcontractors of the Vendor, shall be deemed to be employees of the State for any purpose whatsoever. Vendor shall be exclusively responsible for payment of employees and contractors for all wages and salaries, taxes, withholding payments, penalties, fees, fringe benefits, professional liability insurance premiums, contributions to insurance and pension, or other deferred compensation plans, including but not limited to, Workers' Compensation and Social Security obligations, licensing fees, etc. and the filing of all necessary documents, forms, and returns pertinent to all of the foregoing.

Vendor shall hold harmless the State, and shall provide the State and Agency with a defense against any and all claims including, but not limited to, the foregoing payments, withholdings, contributions, taxes, Social Security taxes, and employer income tax returns.

36. INDEMNIFICATION: The Vendor agrees to indemnify, defend, and hold harmless the State and the Agency, their officers, and employees from and against: (1) Any claims or losses for services rendered by any subcontractor, person, or firm performing or supplying services, materials, or supplies in connection with the performance of the Contract; (2) Any claims or losses resulting to any person or entity injured or damaged by the Vendor, its officers, employees, or subcontractors by the publication, translation, reproduction, delivery, performance, use, or disposition of any data used under the Contract in a manner not authorized by the Contract, or by Federal or State statutes or regulations; and (3) Any failure of the Vendor, its officers, employees, or subcontractors to observe State and Federal laws including, but not limited to, labor and wage and hour laws.

37. NO DEBT CERTIFICATION: In accordance with West Virginia Code §§ 5A-3-10a and 5-22-1(i), the State is prohibited from awarding a contract to any bidder that owes a debt to the State or a political subdivision of the State. By submitting a bid, or entering into a contract with the State, Vendor is affirming that (1) for construction contracts, the Vendor is not in default on any monetary obligation owed to the state or a political subdivision of the state, and (2) for all other contracts, neither the Vendor nor any related party owe a debt as defined above, and neither the Vendor nor any related party are in employer default as defined in the statute cited above unless the debt or employer default is permitted under the statute.

38. CONFLICT OF INTEREST: Vendor, its officers or members or employees, shall not presently have or acquire an interest, direct or indirect, which would conflict with or compromise the performance of its obligations hereunder. Vendor shall periodically inquire of its officers, members and employees to ensure that a conflict of interest does not arise. Any conflict of interest discovered shall be promptly presented in detail to the Agency.

39. REPORTS: Vendor shall provide the Agency and/or the Purchasing Division with the following reports identified by a checked box below:

Such reports as the Agency and/or the Purchasing Division may request. Requested reports may include, but are not limited to, quantities purchased, agencies utilizing the contract, total contract expenditures by agency, etc.

Quarterly reports detailing the total quantity of purchases in units and dollars, along with a listing of purchases by agency. Quarterly reports should be delivered to the Purchasing Division via email at purchasing.division@wv.gov.

40. BACKGROUND CHECK: In accordance with W. Va. Code § 15-2D-3, the State reserves the right to prohibit a service provider's employees from accessing sensitive or critical information or to be present at the Capitol complex based upon results addressed from a criminal background check. Service providers should contact the West Virginia Division of Protective Services by phone at (304) 558-9911 for more information.

41. PREFERENCE FOR USE OF DOMESTIC STEEL PRODUCTS: Except when authorized by the Director of the Purchasing Division pursuant to W. Va. Code § 5A-3-56, no contractor may use or supply steel products for a State Contract Project other than those steel products made in the United States. A contractor who uses steel products in violation of this section may be subject to civil penalties pursuant to W. Va. Code § 5A-3-56. As used in this section:

- a. "State Contract Project" means any erection or construction of, or any addition to, alteration of or other improvement to any building or structure, including, but not limited to, roads or highways, or the installation of any heating or cooling or ventilating plants or other equipment, or the supply of and materials for such projects, pursuant to a contract with the State of West Virginia for which bids were solicited on or after June 6, 2001.
- b. "Steel Products" means products rolled, formed, shaped, drawn, extruded, forged, cast, fabricated or otherwise similarly processed, or processed by a combination of two or more or such operations, from steel made by the open heath, basic oxygen, electric furnace, Bessemer or other steel making process.
- c. The Purchasing Division Director may, in writing, authorize the use of foreign steel products if:
 1. The cost for each contract item used does not exceed one tenth of one percent (.1%) of the total contract cost or two thousand five hundred dollars (\$2,500.00), whichever is greater. For the purposes of this section, the cost is the value of the steel product as delivered to the project; or
 2. The Director of the Purchasing Division determines that specified steel materials are not produced in the United States in sufficient quantity or otherwise are not reasonably available to meet contract requirements.

42. PREFERENCE FOR USE OF DOMESTIC ALUMINUM, GLASS, AND STEEL: In Accordance with W. Va. Code § 5-19-1 et seq., and W. Va. CSR § 148-10-1 et seq., for every contract or subcontract, subject to the limitations contained herein, for the construction, reconstruction, alteration, repair, improvement or maintenance of public works or for the purchase of any item of machinery or equipment to be used at sites of public works, only domestic aluminum, glass or steel products shall be supplied unless the spending officer determines, in writing, after the receipt of offers or bids, (1) that the cost of domestic aluminum, glass or steel products is unreasonable or inconsistent with the public interest of the State of West Virginia, (2) that domestic aluminum, glass or steel products are not produced in sufficient quantities to meet the contract requirements, or (3) the available domestic aluminum, glass, or steel do not meet the contract specifications. This provision only applies to public works contracts awarded in an amount more than fifty thousand dollars (\$50,000) or public works contracts that require more than ten thousand pounds of steel products.

The cost of domestic aluminum, glass, or steel products may be unreasonable if the cost is more than twenty percent (20%) of the bid or offered price for foreign made aluminum, glass, or steel products. If the domestic aluminum, glass or steel products to be supplied or produced in a "substantial labor surplus area", as defined by the United States Department of Labor, the cost of domestic aluminum, glass, or steel products may be unreasonable if the cost is more than thirty percent (30%) of the bid or offered price for foreign made aluminum, glass, or steel

Revised 07/01/2022

products. This preference shall be applied to an item of machinery or equipment, as indicated above, when the item is a single unit of equipment or machinery manufactured primarily of aluminum, glass or steel, is part of a public works contract and has the sole purpose or of being a permanent part of a single public works project. This provision does not apply to equipment or machinery purchased by a spending unit for use by that spending unit and not as part of a single public works project.

All bids and offers including domestic aluminum, glass or steel products that exceed bid or offer prices including foreign aluminum, glass or steel products after application of the preferences provided in this provision may be reduced to a price equal to or lower than the lowest bid or offer price for foreign aluminum, glass or steel products plus the applicable preference. If the reduced bid or offer prices are made in writing and supersede the prior bid or offer prices, all bids or offers, including the reduced bid or offer prices, will be reevaluated in accordance with this rule.

43. INTERESTED PARTY SUPPLEMENTAL DISCLOSURE: W. Va. Code § 6D-1-2 requires that for contracts with an actual or estimated value of at least \$1 million, the Vendor must submit to the Agency a disclosure of interested parties prior to beginning work under this Contract. Additionally, the Vendor must submit a supplemental disclosure of interested parties reflecting any new or differing interested parties to the contract, which were not included in the original pre-work interested party disclosure, within 30 days following the completion or termination of the contract. A copy of that form is included with this solicitation or can be obtained from the WV Ethics Commission. This requirement does not apply to publicly traded companies listed on a national or international stock exchange. A more detailed definition of interested parties can be obtained from the form referenced above.

44. PROHIBITION AGAINST USED OR REFURBISHED: Unless expressly permitted in the solicitation published by the State, Vendor must provide new, unused commodities, and is prohibited from supplying used or refurbished commodities, in fulfilling its responsibilities under this Contract.

45. VOID CONTRACT CLAUSES – This Contract is subject to the provisions of West Virginia Code § 5A-3-62, which automatically voids certain contract clauses that violate State law.

46. ISRAEL BOYCOTT: Bidder understands and agrees that, pursuant to W. Va. Code § 5A-3-63, it is prohibited from engaging in a boycott of Israel during the term of this contract.

ADDITIONAL TERMS AND CONDITIONS (Construction Contracts Only)

1. CONTRACTOR'S LICENSE: Until June 15, 2021, West Virginia Code § 21-11-2, and after that date, § 30-42-2, requires that all persons desiring to perform contracting work in this state be licensed. The West Virginia Contractors Licensing Board is empowered to issue the contractor's license. Applications for a contractor's license may be made by contacting the West Virginia Contractor Licensing Board.

The apparent successful Vendor must furnish a copy of its contractor's license prior to the issuance of a contract award document.

2. DRUG-FREE WORKPLACE AFFIDAVIT: W. Va. Code § 21-1D-5 provides that any solicitation for a public improvement contract requires each Vendor that submits a bid for the work to submit an affidavit that the Vendor has a written plan for a drug-free workplace policy. If the affidavit is not submitted with the bid submission, the Purchasing Division shall promptly request by telephone and electronic mail that the low bidder and second low bidder provide the affidavit within one business day of the request. Failure to submit the affidavit within one business day of receiving the request shall result in disqualification of the bid. To comply with this law, Vendor should complete the enclosed drug-free workplace affidavit and submit the same with its bid. Failure to submit the signed and notarized drugfree workplace affidavit or a similar affidavit that fully complies with the requirements of the applicable code, within one business day of being requested to do so shall result in disqualification of Vendor's bid. Pursuant to W. Va. Code 21-1D-2(b) and (k), this provision does not apply to public improvement contracts the value of which is \$100,000 or less or temporary or emergency repairs.

2.1. DRUG-FREE WORKPLACE POLICY: Pursuant to W. Va. Code § 21-1D-4, Vendor and its subcontractors must implement and maintain a written drug-free workplace policy that complies with said article. The awarding public authority shall cancel this contract if: (1) Vendor fails to implement and maintain a written drug-free workplace policy described in the preceding paragraph, (2) Vendor fails to provide information regarding implementation of its drug-free workplace policy at the request of the public authority; or (3) Vendor provides to the public authority false information regarding the contractor's drug-free workplace policy.

Pursuant to W. Va. Code 21-1D-2(b) and (k), this provision does not apply to public improvement contracts the value of which is \$100,000 or less or temporary or emergency repairs.

3. DRUG FREE WORKPLACE REPORT: Pursuant to W. Va. Code § 21-1D-7b, no less than once per year, or upon completion of the project, every contractor shall provide a certified report to the public authority which let the contract. For contracts over \$25,000, the public authority shall be the West Virginia Purchasing Division. For contracts of \$25,000 or less, the public authority shall be the agency issuing the contract. The report shall include:

(1) Information to show that the education and training service to the requirements of West Virginia Code § 21-1D-5 was provided;

(2) The name of the laboratory certified by the United States Department of Health and Human Services or its successor that performs the drug tests;

(3) The average number of employees in connection with the construction on the public improvement;

(4) Drug test results for the following categories including the number of positive tests and the number of negative tests: (A) Pre-employment and new hires; (B) Reasonable suspicion; (C) Post-accident; and (D) Random.

Vendor should utilize the attached Certified Drug Free Workplace Report Coversheet when submitting the report required hereunder. Pursuant to W. Va. Code 21-1D-2(b) and (k), this provision does not apply to public improvement contracts the value of which is \$100,000 or less or temporary or emergency repairs.

4. AIA DOCUMENTS: All construction contracts that will be completed in conjunction with architectural services procured under Chapter 5G of the West Virginia Code will be governed by the attached AIA documents, as amended by the Supplementary Conditions for the State of West Virginia, in addition to the terms and conditions contained herein.

4A. PROHIBITION AGAINST GENERAL CONDITIONS: Notwithstanding anything contained in the AIA Documents or the Supplementary Conditions, the State of West Virginia will not pay for general conditions, or winter conditions, or any other condition representing a delay in the contracts. The Vendor is expected to mitigate delay costs to the greatest extent possible and any costs associated with Delays must be specifically and concretely identified. The state will not consider an average daily rate multiplied by the number of days extended to be an acceptable charge.

5. GREEN BUILDINGS MINIMUM ENERGY STANDARDS: In accordance with § 22-29-4, all new building construction projects of public agencies that have not entered the schematic design phase prior to July 1, 2012, or any building construction project receiving state grant funds and appropriations, including public schools, that have not entered the schematic design phase prior to July 1, 2012, shall be designed and constructed complying with the ICC International Energy Conservation Code, adopted by the State Fire Commission, and the ANSI/ASHRAE/IESNA Standard 90.1-2007: Provided, That if any construction project has a commitment of federal funds to pay for a portion of such project, this provision shall only apply to the extent such standards are consistent with the federal standards.

6. LOCAL LABOR MARKET HIRING REQUIREMENT: Pursuant to West Virginia Code §21-1C-1 et seq., Employers shall hire at least seventy-five percent of employees for public improvement construction projects from the local labor market, to be rounded off, with at least two employees from outside the local labor market permissible for each employer per project.

Any employer unable to employ the minimum number of employees from the local labor market shall inform the nearest office of Workforce West Virginia of the number of qualified employees needed and provide a job description of the positions to be filled.

If, within three business days following the placing of a job order, Workforce West Virginia is unable to refer any qualified job applicants to the employer or refers less qualified job applicants than the number requested, then Workforce West Virginia shall issue a waiver to the employer

stating the unavailability of applicant and shall permit the employer to fill any positions covered by the waiver from outside the local labor market. The waiver shall be in writing and shall be issued within the prescribed three days. A waiver certificate shall be sent to both the employer for its permanent project records and to the public authority.

Any employer who violates this requirement is subject to a civil penalty of \$250 per each employee less than the required threshold of seventy-five percent per day of violation after receipt of a notice of violation.

Any employer that continues to violate any provision of this article more than fourteen calendar days after receipt of a notice of violation is subject to a civil penalty of \$500 per each employee less than the required threshold of seventy-five percent per day of violation.

The following terms used in this section have the meaning shown below.

(1) The term “construction project” means any construction, reconstruction, improvement, enlargement, painting, decorating or repair of any public improvement let to contract in an amount equal to or greater than \$500,000. The term “construction project” does not include temporary or emergency repairs;

(2) The term “employee” means any person hired or permitted to perform hourly work for wages by a person, firm or corporation in the construction industry; The term “employee” does not include:(i) Bona fide employees of a public authority or individuals engaged in making temporary or emergency repairs;(ii) Bona fide independent contractors; or(iii) Salaried supervisory personnel necessary to assure efficient execution of the employee's work;

(3) The term “employer” means any person, firm or corporation employing one or more employees on any public improvement and includes all contractors and subcontractors;

(4) The term “local labor market” means every county in West Virginia and any county outside of West Virginia if any portion of that county is within fifty miles of the border of West Virginia;

(5) The term “public improvement” includes the construction of all buildings, roads, highways, bridges, streets, alleys, sewers, ditches, sewage disposal plants, waterworks, airports and all other structures that may be let to contract by a public authority, excluding improvements funded, in whole or in part, by federal funds.

7. DAVIS-BACON AND RELATED ACT WAGE RATES:

The work performed under this contract is federally funded in whole, or in part. Pursuant to 2 CFR 200.317, Vendors are required to pay applicable Davis-Bacon wage rates.

The work performed under this contract is not subject to Davis-Bacon wage rates.

8. SUBCONTRACTOR LIST SUBMISSION: In accordance with W. Va. Code § 5-22-1, the apparent low bidder on a contract valued at more than \$250,000.00 for the construction, alteration, decoration, painting or improvement of a new or existing building or structure shall submit a list of all subcontractors who will perform more than \$25,000.00 of work on the project including labor and materials. (This section does not apply to any other construction projects, such as highway, mine reclamation, water or sewer projects.) The subcontractor list shall be provided to the Purchasing Division within one business day of the opening of bids for review.

If the apparent low bidder fails to submit the subcontractor list, the Purchasing Division shall promptly request by telephone and electronic mail that the low bidder and second low bidder provide the subcontractor list within one business day of the request. Failure to submit the subcontractor list within one business day of receiving the request shall result in disqualification of the bid.

If no subcontractors who will perform more than \$25,000.00 of work are to be used to complete the project, the apparent low bidder must make this clear on the subcontractor list, in the bid itself, or in response to the Purchasing Division's request for the subcontractor list.

a. Required Information. The subcontractor list must contain the following information:

i. Bidder's name

ii. Name of each subcontractor performing more than \$25,000 of work on the project.

iii. The license number of each subcontractor, as required by W. Va. Code § 21-11-1 et. seq.

iv. If applicable, a notation that no subcontractor will be used to perform more than \$25,000.00 of work. (This item iv. is not required if the vendor makes this clear in the bid itself or in documentation following the request for the subcontractor list.)

b. Subcontractor List Submission Form: The subcontractor list may be submitted in any form, including the attached form, as long as the required information noted above is included. If any information is missing from the bidder's subcontractor list submission, it may be obtained from other documents such as bids, emails, letters, etc. that accompany the subcontractor list submission.

c. Substitution of Subcontractor. Written approval must be obtained from the State Spending Unit before any subcontractor substitution is permitted. Substitutions are not permitted unless:

i. The subcontractor listed in the original bid has filed for bankruptcy;

ii. The subcontractor in the original bid has been debarred or suspended; or

iii. The contractor certifies in writing that the subcontractor listed in the original bid fails, is unable, or refuses to perform his subcontract.

Subcontractor List Submission (Construction Contracts Only)

Bidder's Name: Wolf Creek Contracting Company, LLC

Check this box if no subcontractors will perform more than \$25,000.00 of work to complete the project.

Subcontractor Name	License Number if Required by W. Va. Code § 21-11-1 et. seq.
Mid Atlantic Maintenance	WV047493

Attach additional pages if necessary

DESIGNATED CONTACT: Vendor appoints the individual identified in this Section as the Contract Administrator and the initial point of contact for matters relating to this Contract.

Julie Wagner Construction Administrator
(Name, Title)
Julie Wagner - Construction Administrator
(Printed Name and Title)
403 Watertown Road, Waterford, OH 45786
(Address)
740-749-5772 / 740-422-1244
(Phone Number) / (Fax Number)
jwagner@wolfcreekcontractors.com
(email address)

CERTIFICATION AND SIGNATURE: By signing below, or submitting documentation through wvOASIS, I certify that: I have reviewed this Solicitation in its entirety; that I understand the requirements, terms and conditions, and other information contained herein; that this bid, offer or proposal constitutes an offer to the State that cannot be unilaterally withdrawn; that the product or service proposed meets the mandatory requirements contained in the Solicitation for that product or service, unless otherwise stated herein; that the Vendor accepts the terms and conditions contained in the Solicitation, unless otherwise stated herein; that I am submitting this bid, offer or proposal for review and consideration; that I am authorized by the vendor to execute and submit this bid, offer, or proposal, or any documents related thereto on vendor's behalf; that I am authorized to bind the vendor in a contractual relationship; and that to the best of my knowledge, the vendor has properly registered with any State agency that may require registration.

By signing below, I further certify that I understand this Contract is subject to the provisions of West Virginia Code § 5A-3-62, which automatically voids certain contract clauses that violate State law.

Wolf Creek Contracting Company, LLC
(Company)
Doug Taylor Chief Financial Officer
(Authorized Signature) (Representative Name, Title)

Doug Taylor - Chief Financial Officer
(Printed Name and Title of Authorized Representative)

September 7, 2022
(Date)

740-749-5831 / 740-422-1244
(Phone Number) (Fax Number)

REQUEST FOR QUOTATION – CRFQ ADJ23*07
Williamstown AASF#1 Taxiway & Apron Repairs

GENERAL CONSTRUCTION SPECIFICATIONS

1. **PURPOSE AND SCOPE:** The West Virginia Purchasing Division is soliciting bids on behalf of the West Virginia Army National Guard, Construction & Facilities Management Office, to establish a contract for the one-time purchase of all material, labor, tools, taxes, transportation and expendable equipment necessary for the satisfactory and full completion of Williamstown AASF#1 Taxiway & Apron Repairs, located near Williamstown, WV. The Thrasher Group, Inc., is serving as the Architect on this project. This definition of scope is provided only to indicate the very general nature of the work that is more fully defined in the Drawings, Specifications and Project Plans.

Please follow the guidelines below regarding the meeting.

- No more than two (2) representatives of the interested bidder may attend the site visit; to limit group size.
- Site visits will take place the day of the Pre-Bid meeting in small groups as directed by the Agency Project Manager, vendors should plan on the possibility of being onsite for several hours, depending on the number of contractors who attend.
- Visiting bidder representative(s) must abide by all safety precautions for safe social distancing, as prescribed by the Agency Project Manager.
- The site visit is NOT an opportunity to ask or submit technical questions about the project. No verbal representations provided at a site visit are binding in any manner. Interested bidders should submit all technical questions per the instructions in the CRFQ.

2. **DEFINITIONS:** The terms listed below shall have the meanings assigned to them below. Additional definitions can be found in section 2 of the General Terms and Conditions and in the Specification's Manual as defined below.

2.1 "Construction Services" means materials, labor, tools, taxes, transportation and expendable equipment necessary to complete Williamstown AASF#1 Taxiway & Apron Repairs, as more fully described in these specifications and the Drawings/Specifications/Project Manual.

2.2 "Pricing Page" means the pages contained in wvOASIS, attached hereto, or included in the Specifications/Project Manual upon which Vendor should list its proposed price for the Construction Services.

REQUEST FOR QUOTATION – CRFQ ADJ23*07
Williamstown AASF#1 Taxiway & Apron Repairs

2.3 “Solicitation” means the official notice of an opportunity to supply the State with Construction Services that is published by the Purchasing Division.

2.4 “Specifications/Project Manual” means the American Institute of Architect forms, specifications, plans, drawings, and related documents developed by the architect, engineer, or Agency that provide detailed instructions on how the Construction Services are to be performed along with any American Institute of Architects documents (“AIA documents”) attached thereto.

- 3. ORDER OF PRECEDENCE:** This General Construction Specifications document will have priority over, and supersede, anything contained in the Specifications/Project Manual.
- 4. QUALIFICATIONS:** Vendor, or Vendor’s staff if requirements are inherently limited to individuals rather than corporate entities, shall have the following minimum qualifications:
- 4.1. Experience:** Vendor, or Vendor’s supervisory staff assigned to this project, must have successfully completed at least 5 (five) projects that involved work similar to that described in the Specifications/Project Manual. Compliance with this experience requirement will be determined prior to contract award by the State through references provided by the Vendor upon request, through knowledge or documentation of the Vendor’s past projects, through confirmation of experience requirements from the architect assisting the State in this project, or some other method that the State determines to be acceptable. Vendor must provide any documentation requested by the State to assist in confirmation of compliance with this provision. References, documentation, or other information to confirm compliance with this experience requirement may be requested after bid opening and prior to contract award.
- 5. CONTRACT AWARD:** The Contract is intended to provide Agency with a purchase price for the Construction Services. The Contract will be awarded to the lowest qualified responsible bidder meeting the required specifications. If the Pricing Pages contain alternates/add-ons, the Contract will be awarded based on the grand total of the base bid and any alternates/add-ons selected. This contract has **Three (3)** alternates.
- 6. SELECTION OF ALTERNATES:** Pursuant to W. Va. Code § 5-22-1(f), any solicitation of bids shall include no more than five alternates. Alternates, if accepted, shall be accepted in the order in which they are listed on the bid form. Any unaccepted alternate contained within a bid shall expire 90 days after the date of the opening of bids for review. Determination of the lowest qualified responsible bidder shall be based on the sum of the base bid and any alternates accepted. Alternate selection will be identified in the Purchase Order. This contract has **Three (3)** alternates.

REQUEST FOR QUOTATION – CRFQ ADJ23*07
Williamstown AASF#1 Taxiway & Apron Repairs

7. **PROGRESS PAYMENTS:** The Vendor will be paid in the form of periodic progress payments for work completed. Payment requests along with documentation supporting the request will be submitted to and reviewed by the Architect. If approved, the Architect will communicate approval to the Owner and Owner will process payment. The Owner reserves the right to withhold liquidated damages from progress payments. Progress payments will be made no more than monthly.

Approval and payment of progress payments will be based on Contractor's submission of a payment allocation schedule which allocates the entire contract sum to payment milestones. Architect and Owner will review the payment allocation and may mandate changes that they believe are necessary.

8. **RETAINAGE:** Agency is entitled to withhold 10% from each progress payment made as retainage. Agency will partially release retainage upon certification of substantial completion by the Architect in accordance with this Contract but will continue to retain amounts sufficient to cover activities needed to reach final completion.

9. **PERFORMANCE:** Vendor shall perform the Construction Services in accordance with this document and the Specifications/Project Manual.

10. **SUBSTANTIAL AND FINAL COMPLETION:** Vendor shall achieve substantial completion by a date to be determined based on the notice to proceed and final completion by a date to be determined based on the notice to proceed. Failure to meet the deadlines established herein, unless extended by change order authorizing additional time free of liquidated damages, will result in liquidated damages being applied.

11. **LIQUIDATED DAMAGES:** Contractor shall pay liquidated damages in the amount of \$1,500.00 per day of delay, plus a one-time fixed cost of \$1,250.00 for Staff Judge Advocate review for work not completed after contract completion date. This clause shall in no way be considered exclusive and shall not limit the State or Agency's right to pursue any other available remedy.

12. **PROJECT PLANS:** Copies of the project plans can be obtained by contacting the entity identified below.

The Thrasher Group, Inc.
600 White Oaks Boulevard
Bridgeport, WV 26330

Information and Bidding Documents for the Project can be found at the following designated website:

REQUEST FOR QUOTATION – CRFQ ADJ23*07
Williamstown AASF#1 Taxiway & Apron Repairs

QuestCDN: <https://tinyurl.com/zu5z8553> Or www.thethrashergroup.com

Bidding Documents may be downloaded from the designated website. Prospective Bidders are urged to register with the designated website as a plan holder, even if Bidding Documents are obtained from a plan room or source other than the designated website in either electronic or paper format.

Prospective Bidders may obtain or examine the Bidding Documents at the Issuing Office on Monday through Friday between the hours of **8:00 am to 5:00 pm** and may obtain copies of the Bidding Documents from the Issuing Office as described below.

Printed copies of the Bidding Documents may be obtained from the Issuing Office by paying the amount of each set listed below.

Bidding Documents may be purchased from the Issuing Office during the hours indicated above. Cost does not include shipping charges. Upon Issuing Office's receipt of payment, printed Bidding Documents or electronic documents will be transmitted to the prospective Bidder. The shipping charge amount will depend on the shipping method requested. Bidding Documents are available for purchase in the following formats:

- Bidding Documents issued as hard copy full-size drawings and hard copy specifications, are available for **\$50.00** per set.
- Bidding Documents issued as hard copy half-size drawings and hard copy specifications, are available for **\$50.00** per set.
- Bidding Documents issued as digital drawings and digital specifications, are available for **\$30.00** per set via the following link:

QuestCDN: <https://tinyurl.com/zu5z8553>

Amounts paid are not subject to refund.

Partial sets of Bidding Documents will not be available from the Issuing Office. Neither Owner nor Engineer will be responsible for full or partial sets of Bidding Documents, including Addenda if any, obtained from sources other than the Issuing Office.

REQUEST FOR QUOTATION – CRFQ ADJ23*07
Williamstown AASF#1 Taxiway & Apron Repairs

Copies of project plans can be examined at the following locations

Contractor's Association of West Virginia
2114 Kanawha Boulevard East
Charleston, WV 25311
(304) 342-1166 FAX: (304) 342-1074

13. SUBSTITUTIONS: Any substitution requests must be submitted in accordance with the official question and answer period described in the INSTRUCTIONS TO VENDORS SUBMITTING BIDS, Paragraph 4. Vendor Question Deadline.

14. FACILITIES ACCESS: Performance of Contract Services may require access cards and/or keys to gain entrance to Agency's facilities. In the event that access cards and/or keys are required:

- 14.1. Vendor must identify principal service personnel which will be issued access cards and/or keys to perform service.
- 14.2. Vendor will be responsible for controlling cards and keys and will pay replacement fee, if the cards or keys become lost or stolen.
- 14.3. Vendor shall notify Agency immediately of any lost, stolen, or missing card or key.
- 14.4. Anyone performing under this Contract will be subject to Agency's security protocol and procedures.
- 14.5. Vendor shall inform all staff of Agency's security protocol and procedures.

15. MISCELLANEOUS:

15.1. Contract Manager: During its performance of this Contract, Vendor must designate and maintain a primary contract manager responsible for overseeing Vendor's responsibilities under this Contract. The Contract manager must be available during normal business hours to address any customer service or other issues related to this Contract. Vendor should list its Contract manager and his or her contact information below.

Contract Manager: _____

REQUEST FOR QUOTATION – CRFQ ADJ23*07
Williamstown AASF#1 Taxiway & Apron Repairs

Telephone Number: _____

Fax Number: _____

Email Address: _____

15.2. Owner's Representative: Owner's representative for notice purposes is

Name: ___Jim Skaggs_____

Telephone Number: ___304-561-6550_____

Email Address: ___robert.a.skaggsii.nfg@army.mil___

16. Initial Decision Maker: ___The Thrasher Group, Inc._____, the Architect, shall serve as the Initial Decision Maker in matters relating to this contract.



Department of Administration
 Purchasing Division
 2019 Washington Street East
 Post Office Box 50130
 Charleston, WV 25305-0130

State of West Virginia
 Centralized Request for Quote

Proc Folder: 1089036			Reason for Modification: Addendum No. 1 to provide pre-bid sign-in in sheets, and provide revised drawings, see attached.
Doc Description: Williamstown AASF#1 Taxiway & Apron Repairs (Construction)			
Proc Type: Central Purchase Order			
Date Issued	Solicitation Closes	Solicitation No	Version
2022-08-19	2022-09-01 13:30	CRFQ 0603 ADJ2300000007	2

BID RECEIVING LOCATION
BID CLERK DEPARTMENT OF ADMINISTRATION PURCHASING DIVISION 2019 WASHINGTON ST E CHARLESTON WV 25305 US

VENDOR
Vendor Customer Code: Vendor Name : Address : Street : City : State : Country : Zip : Principal Contact : Vendor Contact Phone: Extension:

FOR INFORMATION CONTACT THE BUYER
David H Pauline 304-558-0067 david.h.pauline@wv.gov

Vendor Signature X	FEIN#	DATE
---------------------------	--------------	-------------

All offers subject to all terms and conditions contained in this solicitation

ADDITIONAL INFORMATION
Addendum No. 1
1) Provide copies of the Pre-Bid Sign-in sheets for the solicitation-(see attached) 2) Provide revised drawings from the Architect for the solicitation- (see attached)
Bid opening remains September 1, 2022 at 1:30 pm est.
No other changes.

INVOICE TO	SHIP TO
ADJUTANT GENERALS OFFICE 1707 COONSKIN DR	ARMY AVIATION SUPPORT FACILITY 1 387 AVIATION DR
CHARLESTON WV US	WILLIAMSTOWN WV US

Line	Comm Ln Desc	Qty	Unit Issue	Unit Price	Total Price
1	Williamstown AASF#1 Taxiway & Apron Repairs (Construction)				

Comm Code	Manufacturer	Specification	Model #
72152700			

Extended Description:
BASE BID (Per documentation)- Provide and furnish all labor, materials, tools, expendable equipment and all services to complete Williamstown AASF#1 Taxiway & Apron Repairs, near Williamstown WV per the attached specifications and documentation.

INVOICE TO	SHIP TO
ADJUTANT GENERALS OFFICE 1707 COONSKIN DR	ARMY AVIATION SUPPORT FACILITY 1 387 AVIATION DR
CHARLESTON WV US	WILLIAMSTOWN WV US

Line	Comm Ln Desc	Qty	Unit Issue	Unit Price	Total Price
2	ADD-ALTERNATE 1- Per the Drawings & Specifications				

Comm Code	Manufacturer	Specification	Model #
72152700			

Extended Description:
ADD- ALTERNATE NO.1(Per documentation)- Provide and furnish all labor, materials, tools, expendable equipment and all services to complete construction per Drawings and Specifications

INVOICE TO		SHIP TO	
ADJUTANT GENERALS OFFICE 1707 COONSKIN DR		ARMY AVIATION SUPPORT FACILITY 1 387 AVIATION DR	
CHARLESTON	WV	WILLIAMSTOWN	WV
US		US	

Line	Comm Ln Desc	Qty	Unit Issue	Unit Price	Total Price
3	ADD-ALTERNATE 2- Per the Drawings & Specifications				

Comm Code	Manufacturer	Specification	Model #
72152700			

Extended Description:

ADD- ALTERNATE NO.2(Per documentation)- Provide and furnish all labor, materials, tools, expendable equipment and all services to complete construction per Drawings and Specifications

INVOICE TO		SHIP TO	
ADJUTANT GENERALS OFFICE 1707 COONSKIN DR		ARMY AVIATION SUPPORT FACILITY 1 387 AVIATION DR	
CHARLESTON	WV	WILLIAMSTOWN	WV
US		US	

Line	Comm Ln Desc	Qty	Unit Issue	Unit Price	Total Price
4	ADD-ALTERNATE 3- Per the Drawings & Specifications				

Comm Code	Manufacturer	Specification	Model #
72152700			

Extended Description:

ADD- ALTERNATE NO. 3 (Per documentation)- Provide and furnish all labor, materials, tools, expendable equipment and all services to complete construction per Drawings and Specifications

SCHEDULE OF EVENTS

<u>Line</u>	<u>Event</u>	<u>Event Date</u>
1	Mandatory Pre-Bid Meeting at 10:30 am est.	2022-08-17
2	Vendor Technical Questions Due By Noon est.	2022-08-26

	Document Phase	Document Description	Page 4
ADJ2300000007	Draft	Williamstown AASF#1 Taxiway & Apron Repairs (Construction)	

ADDITIONAL TERMS AND CONDITIONS

See attached document(s) for additional Terms and Conditions

SOLICITATION NUMBER: CRFQ ADJ2300000007

Addendum Number: 1

The purpose of this addendum is to modify the solicitation identified as CRFQ ADJ2300000007 to reflect the change(s) identified and described below.

Applicable Addendum Category:

- Modify bid opening date and time
- Modify specifications of product or service being sought
- To respond to technical questions
- Attachment of pre-bid sign-in sheet
- Correction of error
- Other

Additional Documentation:

1. To attach pre-bid sign-in sheets, see attached.
2. To provide revised drawing from the Architect for the solicitation, see attached.
3. Bid opening date and time remains September 1, 2022, at 1:30 pm est.
4. No other changes.

Terms and Conditions:

1. All provisions of the Solicitation and other addenda not modified herein shall remain in full force and effect.
2. Vendor should acknowledge receipt of all addenda issued for this Solicitation by completing an Addendum Acknowledgment, a copy of which is included herewith. Failure to acknowledge addenda may result in bid disqualification. The addendum acknowledgement should be submitted with the bid to expedite document processing.

Pre-Bid Sign-In Sheet

Solicitation Number: ADJ2300000007

Date of Pre-Bid Meeting: August 17th, 2022

Location of Prebid Meeting: Williamstown, WV

Please Note:

Vendors must sign-in on this sheet to verify attendance at the Pre-Bid meeting.
 Failure to legibly sign in may be grounds for declaring a vendor ineligible to bid.
 For further verification, please also provide a business card if possible.

Firm Represented:*	Rep Name (Printed):	Firm Address:	Telephone #:	Fax #:	Email:
CFMU	Jim Staggis	Charleston, WV	304-561-6550		
CFMO	Craig Welch	Charleston, WV	304-881-2369		
WV Military Authority	Dean Winger	1707 Wainwright Pr We Charleston WV 25311	304 561-6629		
Wolfes excavating	Trent Shepherd	70 Columbia Blvd Clarksburg WV 26301	304-771-7906		TShepherd@wolfesexcavating.com
Mid Atlantic Maintenance	Austin Edman	PO Box 3405 ²⁶¹⁰³ Parkersburg WV	304 483 4360		aedman@midatlanticusa.com
The Thrasher Group	Nicole Jones	600 White Oaks Blvd Bridgeport, WV 26330	304-423-5991		njones@thetrashergroup.com

***One Vendor Per Representative - No one individual is permitted to represent more than one vendor at the pre-bid meeting. Any individual that does attempt to represent two or more vendors will be required to select one vendor to which the individual's attendance will be attributed. The vendors not selected will be deemed to have not attended the pre-bid meeting unless another individual attended on their behalf.**

Pre-Bid Sign-In Sheet

Solicitation Number: ADJ2300000007

Date of Pre-Bid Meeting: August 17th, 2022

Location of Prebid Meeting: Williamstown, WV

Please Note:

Vendors must sign-in on this sheet to verify attendance at the Pre-Bid meeting.
 Failure to legibly sign in may be grounds for declaring a vendor ineligible to bid.
 For further verification, please also provide a business card if possible.

Firm Represented:*	Rep Name (Printed):	Firm Address:	Telephone #:	Fax #:	Email:
Mountaineer Contractors	Chris Shumow	P.O. Box 606 Kingwood WV 26537	304-552-4330		Chris.Shumow@MTCWV.com
Wolf Creek Contracting	Rou Patterson	408 Watertown Rd Waterford, OH	304-538-4768		RPatterson@WolfCreekContractors.com
Bear Contracting	Eric Sprouse	1 Columbia Blvd Clarksburg, WV	304-326-0160		estimating@bear-contracting.com

***One Vendor Per Representative** - No one individual is permitted to represent more than one vendor at the pre-bid meeting. Any individual that does attempt to represent two or more vendors will be required to select one vendor to which the individual's attendance will be attributed. The vendors not selected will be deemed to have not attended the pre-bid meeting unless another individual attended on their behalf.



THRASHER
 800 WHITE OAKS BLVD,
 P.O. BOX 840
 BRIDGEPORT, WV 26330
 P (304) 834-4108
 F (304) 524-7821
 www.thrashergroup.com

THE INFORMATION CONTAINED HEREIN IS THE SOLE PROPERTY OF THRASHER GROUP, INC. NO REPRODUCTION OF THIS DOCUMENT IS PERMITTED WITHOUT THE WRITTEN PERMISSION OF THRASHER GROUP, INC.

NO.	REV.	DATE	DESCRIPTION
1	001	7/16/22	ISSUED THROUGH THE PROJECT AS A PERMITS DRAWING

WILLIAMSTOWN AASF #1
TAXWAY AND APRON REPAIRS
 WEST VIRGINIA ARMY NATIONAL GUARD
 WOOD COUNTY, WEST VIRGINIA
 JUNE 22, 2022
 CONSTRUCTION PLANS

DRAWN: DATE:
 CHECKED: DATE:
 APPROVED: DATE:

PROJECT NO.
 T80-1104

SITE PLAN OVERALL
3

CAD FILE: R:\DATA\150-1001-00-Storm Rehab-WV\150-1001-00-Storm Rehab-WV.dwg PLOT DATE/TIME: 8/15/2022 3:47 AM USBC - COPY RITER LATITUDE: 4-30E PLAN



- #### PLAN NOTES
1. ALL PROPOSED CONCRETE JOINTS SHALL MATCH THE EXISTING JOINT TYPE (CONSTRUCTION AND/OR EXPANSION) AND JOINT LOCATION
 2. AREAS OF APRON THAT HAVE EXISTING STRIPING SHALL BE REPLACED PRIOR TO CONCRETE BEING OPENED TO TRAFFIC.
 3. ALL JOINTS TO BE SEALED SHALL BE THOROUGHLY CLEANED REMOVING ALL DIRT AND LOOSE CONCRETE PRIOR TO RE-SEALING.
 4. CONTROL POINT (NAIL) LOCATED AT:
 NORTHING: 317206.8860°
 EASTING: 1418277.1500°
 ELEV.: 830.375°
 11. CONTRACTOR IS RESPONSIBLE FOR ALL MAINTENANCE OF ACCESS TO HANGARS AS WELL AS TO AND FROM THE RUNWAY FOR THE ARMY NATIONAL GUARD. THE CONTRACTOR SHALL COORDINATE CONCRETE REPLACEMENT SCHEDULE WITH THE ARMY NATIONAL GUARD OPERATIONS SCHEDULE SO THAT ACCESS TO AND FROM THE RUNWAY IS MAINTAINED THROUGHOUT CONSTRUCTION.

MATCHLINE SHEET 5

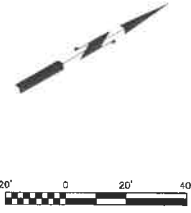

THRASHER
 THE THRASHER GROUP
 500 WHITE OAKS BLVD,
 P.O. BOX 349
 BRIDGEPORT, WV 26330
 P (304) 624-4106
 F (304) 624-7831
 www.thrashergroup.com

THE INFORMATION CONTAINED HEREIN IS THE PROPERTY OF THE THRASHER GROUP AND IS FOR USE ONLY FOR THE PROJECT AND AT THE USER'S SOLE RISK. WITHOUT PRIOR WRITTEN PERMISSION FROM THRASHER GROUP, THIS INFORMATION IS NOT TO BE REPRODUCED, COPIED, OR TRANSMITTED IN ANY MANNER.
 DATE: 06/22/22
 THE THRASHER GROUP, INC.

ID	DATE	BY	DESCRIPTION

WILLIAMSTOWN AASF#1
TAXIWAY AND APRON REPAIRS
 WEST VIRGINIA ARMY NATIONAL GUARD
 WOOD COUNTY, WEST VIRGINIA
 JUNE 22, 2022
 CONSTRUCTION PLANS

DRAWN: _____ DATE: _____
 CHECKED: _____ DATE: _____
 APPROVED: _____ DATE: _____

TAB-1016

PLAN SHEET

4

CAD FILE: R:\003\108-110\102-6\plan Media-PLAN-CONSTRUCTION\101_L_Site_Plan.dwg PLOT DATE/TIME: 6/7/2022 11:55 AM LAYOUT: 2-SITE PLAN USER: csp-wjw

MATCHLINE SHEET 4

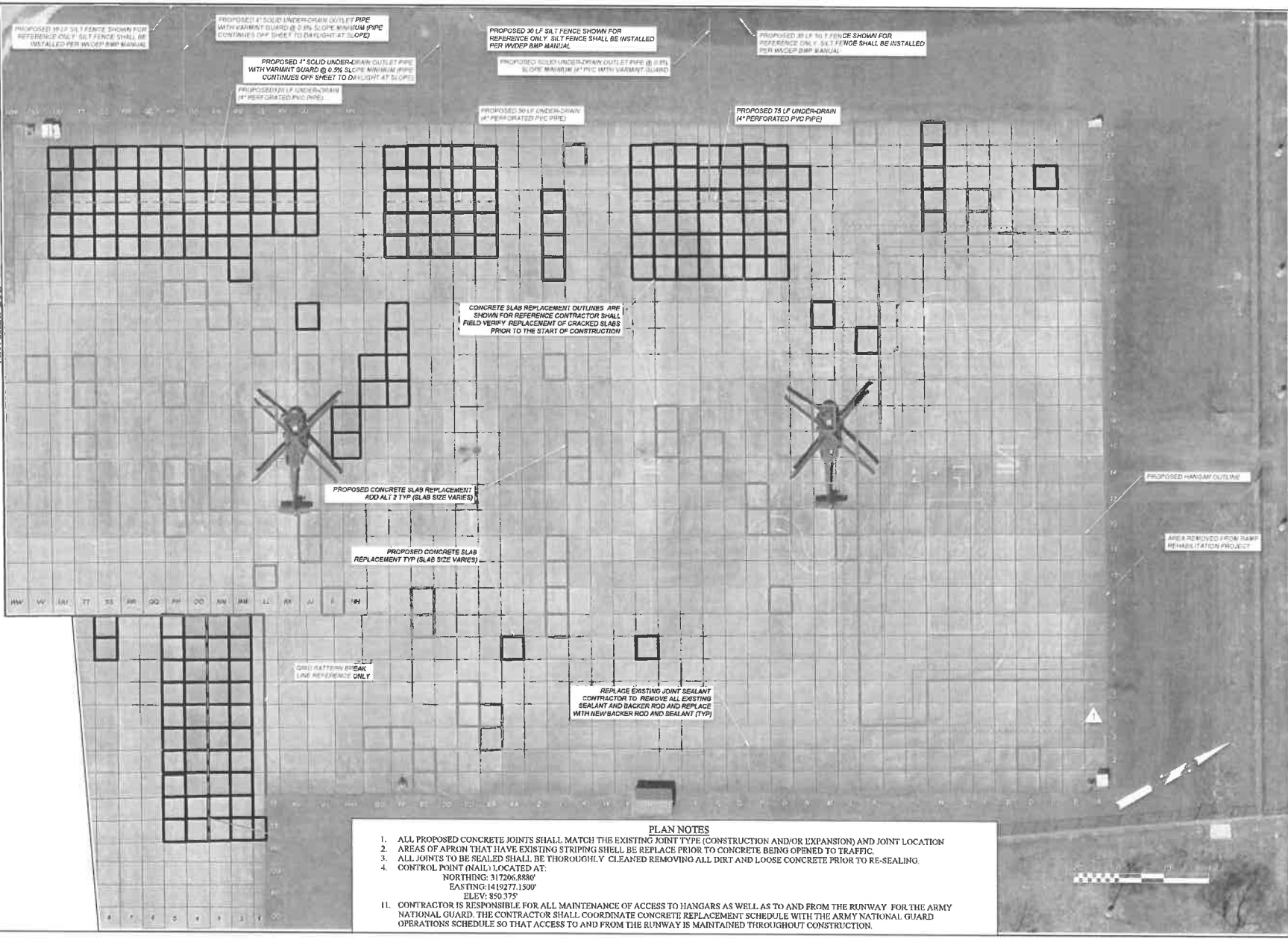

- PLAN NOTES**
1. ALL PROPOSED CONCRETE JOINTS SHALL MATCH THE EXISTING JOINT TYPE (CONSTRUCTION AND/OR EXPANSION) AND JOINT LOCATION
 2. AREAS OF APRON THAT HAVE EXISTING STRIPING SHALL BE REPLACE PRIOR TO CONCRETE BEING OPENED TO TRAFFIC.
 3. ALL JOINTS TO BE SEALED SHALL BE THOROUGHLY CLEANED REMOVING ALL DIRT AND LOOSE CONCRETE PRIOR TO RE-SEALING.
 4. CONTROL POINT (NAIL) LOCATED AT:
NORTHING: 31726.8580'
EASTING: 141927.1500'
ELEV: 850.375'
 11. CONTRACTOR IS RESPONSIBLE FOR ALL MAINTENANCE OF ACCESS TO HANGARS AS WELL AS TO AND FROM THE RUNWAY FOR THE ARMY NATIONAL GUARD. THE CONTRACTOR SHALL COORDINATE CONCRETE REPLACEMENT SCHEDULE WITH THE ARMY NATIONAL GUARD OPERATIONS SCHEDULE SO THAT ACCESS TO AND FROM THE RUNWAY IS MAINTAINED THROUGHOUT CONSTRUCTION.

THRASHER
 10101 WOODHURST BLVD
 FORT WORTH, TX 76116
 P (817) 624-4108
 F (817) 624-7831
 www.thrashergroup.com

THE INFORMATION CONTAINED HEREIN IS THE SOLE PROPERTY OF THRASHER GROUP, INC. NO PORTION OF THIS DOCUMENT IS TO BE REPRODUCED OR TRANSMITTED IN ANY FORM OR BY ANY MEANS WITHOUT THE WRITTEN PERMISSION OF THRASHER GROUP, INC. COPYRIGHT © 2022 THRASHER GROUP, INC.

NO.	REV.	DATE	DESCRIPTION
1	NEW	7/14/22	ISSUED FOR PERMIT. SEE PERMIT FOR FULL HANGAR DETAILS.

**WILLIAMSTOWN AASE#1
 TAXIWAY AND APRON REPAIRS**
 WEST VIRGINIA ARMY NATIONAL GUARD
 WOOD COUNTY, WEST VIRGINIA
 JUNE 22, 2022
 CONSTRUCTION PLANS

DRAWN: DATE:
 CHECKED: DATE:
 APPROVED: DATE:
 PROJECT NO.: T&E-11014

PLAN SHEET

CAD FILE: R:\VRS\150-1101-100-0000-REBAR-RWMC-VIRGINIA\1101-100-0000.dwg
 PLOT DATE/TIME: 6/16/2022 10:12 AM
 LAYER: 7-DETAILS
 USER: cory moyer

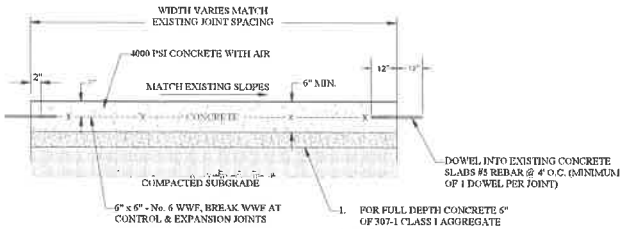

- NOTES:**
1. PLACE EXPANSION JOINT ALONG EXISTING CONCRETE SLABS AND STRUCTURES.
 2. PLACE EXPANSION JOINTS TO MATCH EXISTING EXPANSION JOINT LOCATIONS.
 3. PLACE CONTRACTION JOINTS TO MATCH EXISTING CONTRACTION JOINT LOCATIONS.
 4. FINISH SURFACE WITH A NON-SLIP BROOM SWEEP FINISH.

TYPICAL CONCRETE REPLACEMENT SECTION
NOT TO SCALE

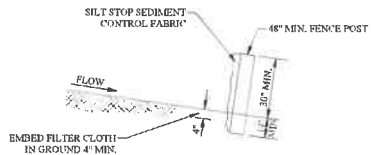

SECTION VIEW

- NOTE:**
1. SET SILT FENCE PARALLEL TO THE CONTOURS AT ALL POINTS ALONG ITS LENGTH

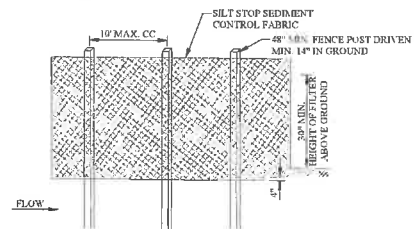

PERSPECTIVE VIEW

SILT FENCE
NOT TO SCALE

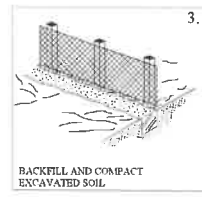
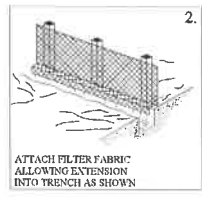
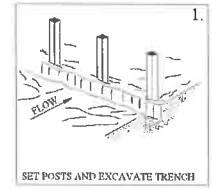

BUILDING SILT FENCE - STEP BY STEP PROCEDURE
NOT TO SCALE

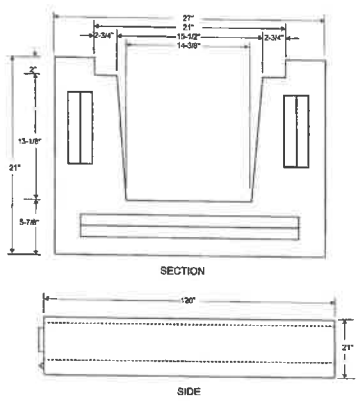

TRENCH DRAIN DETAIL
NOT TO SCALE

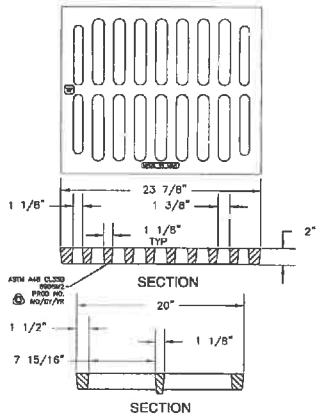

TRENCH GRATE DETAIL
NOT TO SCALE

- NOTES:**
1. THE CONTRACTOR SHALL FURNISH, INSTALL, SECURE AND MAINTAIN THE BARRICADES FOR THE DURATION OF THE PROJECTS COMPLETION.
 2. THE CONTRACTOR SHALL ENSURE THE LIGHTS, BATTERY, AND PHOTOCELL ARE IN WORKING ORDER PRIOR TO LEAVING THE SITE EVERY NIGHT. CONTRACTOR SHALL ENSURE THAT BARRICADES CONFORM TO THE LATEST ADVISORY CIRCULAR AND ARE FILLED WITH WATER OR SAND PRIOR TO MOVEMENT.
 3. BARRICADES SHALL BE LOCATED AS DEFINED IN THE CONSTRUCTION SAFETY AND PHASING PLAN (CSPP) WITH A MAXIMUM SPACING OF 16' O.C. OR AS DIRECTED BY THE ENGINEER.
 4. CONTRACTOR SHALL REPLACE ANY DAMAGED LOW PROFILE BARRICADES AT NO ADDITIONAL COST TO THE OWNER.
 5. LIGHTS MUST BE RED, EITHER BY STEADY BURNING OR FLASHING, AND MUST MEET THE LUMINANCE REQUIREMENT OF THE DIVISION OF HIGHWAYS. LIGHTS MUST BE MOUNTED ON BARRICADES AND SPACED AT NO MORE THAN 10 FT. LIGHTS MUST BE OPERATED BETWEEN SUNSET AND SUNRISE AND DURING PERIODS OF LOW-VISIBILITY WHENEVER THE AIRPORT IS OPEN TO OPERATIONS. THE LIGHTS MAY BE BATTERY POWERED OR OPERATED BY PHOTOCELL, THE CONTRACTOR MAY BE REQUIRED TO RUN THEM ON MANUALLY DURING LOW-VISIBILITY SITUATIONS.

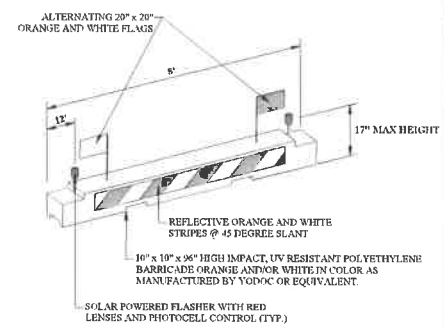

LOW PROFILE AIRCRAFT BARRICADES
NOT TO SCALE

THRASHER
 THE THRASHER GROUP, INC.
 500 WHITE OAK BLVD,
 FLOESCK 940
 BRIDGEPORT, WV 26330
 P (304) 524-4105
 F (304) 524-7851
 www.thrashergroup.com

THE INFORMATION CONTAINED HEREIN IS THE PROPERTY OF THE COMPANY. IT IS TO BE USED ONLY FOR THE PROJECT AND NOT FOR ANY OTHER PURPOSES WITHOUT THE WRITTEN PERMISSION OF THE COMPANY.

NO.	BY	DATE	DESCRIPTION
1	DM	FILED	UPDATE REPLACE DETAIL, STONE ERTING

WILLIAMSTOWN AASF#1
TAXIWAY AND APRON REPAIRS
 WEST VIRGINIA ARMY NATIONAL GUARD
 WOOD COUNTY, WEST VIRGINIA
 JUNE 22, 2022
 CONSTRUCTION PLANS

DRAWN: DATE
 CHECKED: DATE
 APPROVED: DATE

15041014

DETAILS

ADDENDUM ACKNOWLEDGEMENT FORM
SOLICITATION NO.: CRFQ ADJ230000007

Instructions: Please acknowledge receipt of all addenda issued with this solicitation by completing this addendum acknowledgment form. Check the box next to each addendum received and sign below. Failure to acknowledge addenda may result in bid disqualification.

Acknowledgment: I hereby acknowledge receipt of the following addenda and have made the necessary revisions to my proposal, plans and/or specification, etc.

Addendum Numbers Received:

(Check the box next to each addendum received)

- | | | | |
|-------------------------------------|----------------|--------------------------|-----------------|
| <input checked="" type="checkbox"/> | Addendum No. 1 | <input type="checkbox"/> | Addendum No. 6 |
| <input type="checkbox"/> | Addendum No. 2 | <input type="checkbox"/> | Addendum No. 7 |
| <input type="checkbox"/> | Addendum No. 3 | <input type="checkbox"/> | Addendum No. 8 |
| <input type="checkbox"/> | Addendum No. 4 | <input type="checkbox"/> | Addendum No. 9 |
| <input type="checkbox"/> | Addendum No. 5 | <input type="checkbox"/> | Addendum No. 10 |

I understand that failure to confirm the receipt of addenda may be cause for rejection of this bid. I further understand that that any verbal representation made or assumed to be made during any oral discussion held between Vendor's representatives and any state personnel is not binding. Only the information issued in writing and added to the specifications by an official addendum is binding.



Wolf Creek Contracting Company, LLC

Company

Authorized Signature

09/01/2022

Date

NOTE: This addendum acknowledgment should be submitted with the bid to expedite document processing.

ADDITIONAL INFORMATION	
Addendum No. 2	
1) To respond to vendor technical questions, see attached.	
Bid opening remains September 1, 2022 at 1:30 pm est.	
No other changes.	

INVOICE TO		SHIP TO	
ADJUTANT GENERALS OFFICE 1707 COONSKIN DR		ARMY AVIATION SUPPORT FACILITY 1 387 AVIATION DR	
CHARLESTON	WV	WILLIAMSTOWN	WV
US		US	

Line	Comm Ln Desc	Qty	Unit Issue	Unit Price	Total Price
1	Williamstown AASF#1 Taxiway & Apron Repairs (Construction)				

Comm Code	Manufacturer	Specification	Model #
72152700			

Extended Description:

BASE BID (Per documentation)- Provide and furnish all labor, materials, tools, expendable equipment and all services to complete Williamstown AASF#1 Taxiway & Apron Repairs, near Williamstown WV per the attached specifications and documentation.

INVOICE TO		SHIP TO	
ADJUTANT GENERALS OFFICE 1707 COONSKIN DR		ARMY AVIATION SUPPORT FACILITY 1 387 AVIATION DR	
CHARLESTON	WV	WILLIAMSTOWN	WV
US		US	

Line	Comm Ln Desc	Qty	Unit Issue	Unit Price	Total Price
2	ADD-ALTERNATE 1- Per the Drawings & Specifications				

Comm Code	Manufacturer	Specification	Model #
72152700			

Extended Description:

ADD- ALTERNATE NO.1(Per documentation)- Provide and furnish all labor, materials, tools, expendable equipment and all services to complete construction per Drawings and Specifications

INVOICE TO		SHIP TO	
ADJUTANT GENERALS OFFICE 1707 COONSKIN DR		ARMY AVIATION SUPPORT FACILITY 1 387 AVIATION DR	
CHARLESTON US	WV	WILLIAMSTOWN US	WV

Line	Comm Ln Desc	Qty	Unit Issue	Unit Price	Total Price
3	ADD-ALTERNATE 2- Per the Drawings & Specifications				

Comm Code	Manufacturer	Specification	Model #
72152700			

Extended Description:

ADD- ALTERNATE NO.2(Per documentation)- Provide and furnish all labor, materials, tools, expendable equipment and all services to complete construction per Drawings and Specifications

INVOICE TO		SHIP TO	
ADJUTANT GENERALS OFFICE 1707 COONSKIN DR		ARMY AVIATION SUPPORT FACILITY 1 387 AVIATION DR	
CHARLESTON US	WV	WILLIAMSTOWN US	WV

Line	Comm Ln Desc	Qty	Unit Issue	Unit Price	Total Price
4	ADD-ALTERNATE 3- Per the Drawings & Specifications				

Comm Code	Manufacturer	Specification	Model #
72152700			

Extended Description:

ADD- ALTERNATE NO. 3 (Per documentation)- Provide and furnish all labor, materials, tools, expendable equipment and all services to complete construction per Drawings and Specifications

SCHEDULE OF EVENTS

Line	Event	Event Date
1	Mandatory Pre-Bid Meeting at 10:30 am est.	2022-08-17
2	Vendor Technical Questions Due By Noon est.	2022-08-26

	Document Phase	Document Description	Page
ADJ2300000007	Draft	Williamstown AASF#1 Taxiway & Apron Repairs (Construction)	4

ADDITIONAL TERMS AND CONDITIONS

See attached document(s) for additional Terms and Conditions

SOLICITATION NUMBER: CRFQ ADJ2300000007

Addendum Number: 2

The purpose of this addendum is to modify the solicitation identified as CRFQ ADJ2300000007 to reflect the change(s) identified and described below.

Applicable Addendum Category:

- Modify bid opening date and time
- Modify specifications of product or service being sought
- To respond to technical questions
- Attachment of pre-bid sign-in sheet
- Correction of error
- Other

Additional Documentation:

1. To respond to vendor questions, see attached.
2. Bid opening date and time remains September 1, 2022, at 1:30 pm est.
3. No other changes.

Terms and Conditions:

1. All provisions of the Solicitation and other addenda not modified herein shall remain in full force and effect.
2. Vendor should acknowledge receipt of all addenda issued for this Solicitation by completing an Addendum Acknowledgment, a copy of which is included herewith. Failure to acknowledge addenda may result in bid disqualification. The addendum acknowledgement should be submitted with the bid to expedite document processing.

Vendor Questions-CRFQ 0603 ADJ2300000007
Williamstown AASF#1 Taxiway & Apron Repairs (Construction)

1. I have a question about the completion date for this project. Given the relatively late anticipated award and subsequent start date, would the engineer be willing to hold the NTP until next spring to be able to avoid winter concrete work?

Answer) Yes, the OWNER is willing to hold the Notice to Proceed to avoid winter concrete work.

2. Would this project fall under highway construction projects for Davis Bacon wages?

Answer) Yes, this project is to be bid using Davis Bacon Wage rates as stated in the Terms & Conditions and at the Pre-Bid meeting. However, this work has nothing to do with highway construction or the Department of Highways. Davis Bacon wage rates can be found at the Federal Department of Labor's website.

3. Will fence be removed to access the area of the underdrain installation? Or will we need to remove the fence ourselves and replace it when finished?

Answer) The contractor is responsible for removing the fence to install outlet drains, the use of a temporary fencing solution is acceptable, that fence must meet security standards for the site. At the end of the project, the fence must be restored to the original condition.

ADDENDUM ACKNOWLEDGEMENT FORM
SOLICITATION NO.: CRFQ ADJ2300000007

Instructions: Please acknowledge receipt of all addenda issued with this solicitation by completing this addendum acknowledgment form. Check the box next to each addendum received and sign below. Failure to acknowledge addenda may result in bid disqualification.

Acknowledgment: I hereby acknowledge receipt of the following addenda and have made the necessary revisions to my proposal, plans and/or specification, etc.

Addendum Numbers Received:

(Check the box next to each addendum received)

- | | | | |
|-------------------------------------|----------------|--------------------------|-----------------|
| <input type="checkbox"/> | Addendum No. 1 | <input type="checkbox"/> | Addendum No. 6 |
| <input checked="" type="checkbox"/> | Addendum No. 2 | <input type="checkbox"/> | Addendum No. 7 |
| <input type="checkbox"/> | Addendum No. 3 | <input type="checkbox"/> | Addendum No. 8 |
| <input type="checkbox"/> | Addendum No. 4 | <input type="checkbox"/> | Addendum No. 9 |
| <input type="checkbox"/> | Addendum No. 5 | <input type="checkbox"/> | Addendum No. 10 |

I understand that failure to confirm the receipt of addenda may be cause for rejection of this bid. I further understand that that any verbal representation made or assumed to be made during any oral discussion held between Vendor's representatives and any state personnel is not binding. Only the information issued in writing and added to the specifications by an official addendum is binding.



Wolf Creek Contracting Company, LLC
Company

Handwritten Signature
Authorized Signature

09/01/2022
Date

NOTE: This addendum acknowledgment should be submitted with the bid to expedite document processing.

AIA® Document A201® – 2017

General Conditions of the Contract for Construction

for the following PROJECT:

(Name and location or address)

Williamstown AASF #1 Taxiway and Apron Repairs

THE OWNER:

(Name, legal status and address)

WV Army National Guard
1707 Coonskin Drive
Charleston, WV 25311

THE ARCHITECT:

(Name, legal status and address)

The Thrasher Group, Inc.
PO Box 940
600 White Oaks Blvd.
Bridgeport, WV 26330

TABLE OF ARTICLES

- | | |
|----|---|
| 1 | GENERAL PROVISIONS |
| 2 | OWNER |
| 3 | CONTRACTOR |
| 4 | ARCHITECT |
| 5 | SUBCONTRACTORS |
| 6 | CONSTRUCTION BY OWNER OR BY SEPARATE CONTRACTORS |
| 7 | CHANGES IN THE WORK |
| 8 | TIME |
| 9 | PAYMENTS AND COMPLETION |
| 10 | PROTECTION OF PERSONS AND PROPERTY |
| 11 | INSURANCE AND BONDS |
| 12 | UNCOVERING AND CORRECTION OF WORK |
| 13 | MISCELLANEOUS PROVISIONS |

ADDITIONS AND DELETIONS:

The author of this document has added information needed for its completion. The author may also have revised the text of the original AIA standard form. An *Additions and Deletions Report* that notes added information as well as revisions to the standard form text is available from the author and should be reviewed. A vertical line in the left margin of this document indicates where the author has added necessary information and where the author has added to or deleted from the original AIA text.

This document has important legal consequences. Consultation with an attorney is encouraged with respect to its completion or modification.

For guidance in modifying this document to include supplementary conditions, see AIA Document A503™, Guide for Supplementary Conditions.

Init.

AIA Document A201® – 2017. Copyright © 1911, 1915, 1918, 1925, 1937, 1951, 1958, 1961, 1963, 1966, 1970, 1976, 1987, 1997, 2007 and 2017 by The American Institute of Architects. All rights reserved. The "American Institute of Architects," "AIA," the AIA Logo, "A201," and "AIA Contract Documents" are registered trademarks and may not be used without permission. This document was produced by AIA software at 10:53:20 ET on 06/30/2022 under Order No.2054927631 which expires on 08/20/2022, is not for resale, is licensed for one-time use only, and may only be used in accordance with the AIA Contract Documents® Terms of Service. To report copyright violations, e-mail copyright@aia.org.

User Notes:

(1652185154)

- 14 TERMINATION OR SUSPENSION OF THE CONTRACT
- 15 CLAIMS AND DISPUTES

Init.

AIA Document A201® – 2017. Copyright © 1911, 1915, 1918, 1925, 1937, 1951, 1958, 1961, 1963, 1966, 1970, 1976, 1987, 1997, 2007 and 2017 by The American Institute of Architects. All rights reserved. The "American Institute of Architects," "AIA," the AIA Logo, "A201," and "AIA Contract Documents" are registered trademarks and may not be used without permission. This document was produced by AIA software at 10:53:20 ET on 06/30/2022 under Order No.2054927631 which expires on 08/20/2022, is not for resale, is licensed for one-time use only, and may only be used in accordance with the AIA Contract Documents® Terms of Service. To report copyright violations, e-mail copyright@aia.org.
User Notes:

(1652185154)

INDEX

(Topics and numbers in bold are Section headings.)

Acceptance of Nonconforming Work

9.6.6, 9.9.3, **12.3**

Acceptance of Work

9.6.6, 9.8.2, 9.9.3, 9.10.1, 9.10.3, 12.3

Access to Work

3.16, 6.2.1, 12.1

Accident Prevention

10

Acts and Omissions

3.2, 3.3.2, 3.12.8, 3.18, 4.2.3, 8.3.1, 9.5.1, 10.2.5, 10.2.8, 13.3.2, 14.1, 15.1.2, 15.2

Addenda

1.1.1

Additional Costs, Claims for

3.7.4, 3.7.5, 10.3.2, 15.1.5

Additional Inspections and Testing

9.4.2, 9.8.3, 12.2.1, **13.4**

Additional Time, Claims for

3.2.4, 3.7.4, 3.7.5, 3.10.2, 8.3.2, **15.1.6**

Administration of the Contract

3.1.3, **4.2**, 9.4, 9.5

Advertisement or Invitation to Bid

1.1.1

Aesthetic Effect

4.2.13

Allowances

3.8

Applications for Payment

4.2.5, 7.3.9, 9.2, **9.3**, 9.4, 9.5.1, 9.5.4, 9.6.3, 9.7, 9.10

Approvals

2.1.1, 2.3.1, 2.5, 3.1.3, 3.10.2, 3.12.8, 3.12.9, 3.12.10.1, 4.2.7, 9.3.2, 13.4.1

Arbitration

8.3.1, 15.3.2, **15.4**

ARCHITECT

4

Architect, Definition of

4.1.1

Architect, Extent of Authority

2.5, 3.12.7, 4.1.2, 4.2, 5.2, 6.3, 7.1.2, 7.3.4, 7.4, 9.2, 9.3.1, 9.4, 9.5, 9.6.3, 9.8, 9.10.1, 9.10.3, 12.1, 12.2.1, 13.4.1, 13.4.2, 14.2.2, 14.2.4, 15.1.4, 15.2.1

Architect, Limitations of Authority and Responsibility

2.1.1, 3.12.4, 3.12.8, 3.12.10, 4.1.2, 4.2.1, 4.2.2, 4.2.3, 4.2.6, 4.2.7, 4.2.10, 4.2.12, 4.2.13, 5.2.1, 7.4, 9.4.2, 9.5.4, 9.6.4, 15.1.4, 15.2

Architect's Additional Services and Expenses

2.5, 12.2.1, 13.4.2, 13.4.3, 14.2.4

Architect's Administration of the Contract

3.1.3, 3.7.4, 15.2, 9.4.1, 9.5

Architect's Approvals

2.5, 3.1.3, 3.5, 3.10.2, 4.2.7

Architect's Authority to Reject Work

3.5, 4.2.6, 12.1.2, 12.2.1

Architect's Copyright

1.1.7, 1.5

Architect's Decisions

3.7.4, 4.2.6, 4.2.7, 4.2.11, 4.2.12, 4.2.13, 4.2.14, 6.3, 7.3.4, 7.3.9, 8.1.3, 8.3.1, 9.2, 9.4.1, 9.5, 9.8.4, 9.9.1, 13.4.2, 15.2

Architect's Inspections

3.7.4, 4.2.2, 4.2.9, 9.4.2, 9.8.3, 9.9.2, 9.10.1, 13.4

Architect's Instructions

3.2.4, 3.3.1, 4.2.6, 4.2.7, 13.4.2

Architect's Interpretations

4.2.11, 4.2.12

Architect's Project Representative

4.2.10

Architect's Relationship with Contractor

1.1.2, 1.5, 2.3.3, 3.1.3, 3.2.2, 3.2.3, 3.2.4, 3.3.1, 3.4.2, 3.5, 3.7.4, 3.7.5, 3.9.2, 3.9.3, 3.10, 3.11, 3.12, 3.16, 3.18, 4.1.2, 4.2, 5.2, 6.2.2, 7, 8.3.1, 9.2, 9.3, 9.4, 9.5, 9.7, 9.8, 9.9, 10.2.6, 10.3, 11.3, 12, 13.3.2, 13.4, 15.2

Architect's Relationship with Subcontractors

1.1.2, 4.2.3, 4.2.4, 4.2.6, 9.6.3, 9.6.4, 11.3

Architect's Representations

9.4.2, 9.5.1, 9.10.1

Architect's Site Visits

3.7.4, 4.2.2, 4.2.9, 9.4.2, 9.5.1, 9.9.2, 9.10.1, 13.4

Asbestos

10.3.1

Attorneys' Fees

3.18.1, 9.6.8, 9.10.2, 10.3.3

Award of Separate Contracts

6.1.1, 6.1.2

Award of Subcontracts and Other Contracts for Portions of the Work

5.2

Basic Definitions

1.1

Bidding Requirements

1.1.1

Binding Dispute Resolution

8.3.1, 9.7, 11.5, 13.1, 15.1.2, 15.1.3, 15.2.1, 15.2.5, 15.2.6.1, 15.3.1, 15.3.2, 15.3.3, 15.4.1

Bonds, Lien

7.3.4.4, 9.6.8, 9.10.2, 9.10.3

Bonds, Performance, and Payment

7.3.4.4, 9.6.7, 9.10.3, **11.1.2**, 11.1.3, **11.5**

Building Information Models Use and Reliance

1.8

Building Permit

3.7.1

Capitalization

1.3

Certificate of Substantial Completion

9.8.3, 9.8.4, 9.8.5

Init.

AIA Document A201® – 2017. Copyright © 1911, 1915, 1918, 1925, 1937, 1951, 1958, 1961, 1963, 1966, 1970, 1976, 1987, 1997, 2007 and 2017 by The American Institute of Architects. All rights reserved. The "American Institute of Architects," "AIA," the AIA Logo, "A201," and "AIA Contract Documents" are registered trademarks and may not be used without permission. This document was produced by AIA software at 10:53:20 ET on 06/30/2022 under Order No.2054927631 which expires on 08/20/2022, is not for resale, is licensed for one-time use only, and may only be used in accordance with the AIA Contract Documents® Terms of Service. To report copyright violations, e-mail copyright@aia.org.

User Notes:

(1652185154)

Certificates for Payment

4.2.1, 4.2.5, 4.2.9, 9.3.3, **9.4**, 9.5, 9.6.1, 9.6.6, 9.7, 9.10.1, 9.10.3, 14.1.1.3, 14.2.4, 15.1.4

Certificates of Inspection, Testing or Approval
13.4.4

Certificates of Insurance
9.10.2

Change Orders

1.1.1, 3.4.2, 3.7.4, 3.8.2.3, 3.11, 3.12.8, 4.2.8, 5.2.3, 7.1.2, 7.1.3, **7.2**, 7.3.2, 7.3.7, 7.3.9, 7.3.10, 8.3.1, 9.3.1.1, 9.10.3, 10.3.2, 11.2, 11.5, 12.1.2

Change Orders, Definition of

7.2.1

CHANGES IN THE WORK

2.2.2, 3.11, 4.2.8, 7, 7.2.1, 7.3.1, 7.4, 8.3.1, 9.3.1.1, 11.5

Claims, Definition of

15.1.1

Claims, Notice of

1.6.2, 15.1.3

CLAIMS AND DISPUTES

3.2.4, 6.1.1, 6.3, 7.3.9, 9.3.3, 9.10.4, 10.3.3, **15**, 15.4

Claims and Timely Assertion of Claims

15.4.1

Claims for Additional Cost

3.2.4, 3.3.1, 3.7.4, 7.3.9, 9.5.2, 10.2.5, 10.3.2, **15.1.5**

Claims for Additional Time

3.2.4, 3.3.1, 3.7.4, 6.1.1, 8.3.2, 9.5.2, 10.3.2, **15.1.6**

Concealed or Unknown Conditions, Claims for
3.7.4

Claims for Damages

3.2.4, 3.18, 8.3.3, 9.5.1, 9.6.7, 10.2.5, 10.3.3, 11.3, 11.3.2, 14.2.4, 15.1.7

Claims Subject to Arbitration

15.4.1

Cleaning Up

3.15, 6.3

Commencement of the Work, Conditions Relating to

2.2.1, 3.2.2, 3.4.1, 3.7.1, 3.10.1, 3.12.6, 5.2.1, 5.2.3, 6.2.2, 8.1.2, 8.2.2, 8.3.1, 11.1, 11.2, **15.1.5**

Commencement of the Work, Definition of

8.1.2

Communications

3.9.1, **4.2.4**

Completion, Conditions Relating to

3.4.1, 3.11, 3.15, 4.2.2, 4.2.9, 8.2, 9.4.2, 9.8, 9.9.1, 9.10, 12.2, 14.1.2, 15.1.2

COMPLETION, PAYMENTS AND

9

Completion, Substantial

3.10.1, 4.2.9, 8.1.1, 8.1.3, 8.2.3, 9.4.2, 9.8, 9.9.1, 9.10.3, 12.2, 15.1.2

Compliance with Laws

2.3.2, 3.2.3, 3.6, 3.7, 3.12.10, 3.13, 9.6.4, 10.2.2, 13.1, 13.3, 13.4.1, 13.4.2, 13.5, 14.1.1, 14.2.1.3, 15.2.8, 15.4.2, 15.4.3

Concealed or Unknown Conditions

3.7.4, 4.2.8, 8.3.1, 10.3

Conditions of the Contract

1.1.1, 6.1.1, 6.1.4

Consent, Written

3.4.2, 3.14.2, 4.1.2, 9.8.5, 9.9.1, 9.10.2, 9.10.3, 13.2, 15.4.4.2

Consolidation or Joinder

15.4.4

CONSTRUCTION BY OWNER OR BY SEPARATE CONTRACTORS

1.1.4, 6

Construction Change Directive, Definition of
7.3.1

Construction Change Directives

1.1.1, 3.4.2, 3.11, 3.12.8, 4.2.8, 7.1.1, 7.1.2, 7.1.3, **7.3**, 9.3.1.1

Construction Schedules, Contractor's

3.10, 3.11, 3.12.1, 3.12.2, 6.1.3, 15.1.6.2

Contingent Assignment of Subcontracts

5.4, 14.2.2.2

Continuing Contract Performance

15.1.4

Contract, Definition of

1.1.2

CONTRACT, TERMINATION OR SUSPENSION OF THE

5.4.1.1, 5.4.2, 11.5, **14**

Contract Administration

3.1.3, 4, 9.4, 9.5

Contract Award and Execution, Conditions Relating to

3.7.1, 3.10, 5.2, 6.1

Contract Documents, Copies Furnished and Use of

1.5.2, 2.3.6, 5.3

Contract Documents, Definition of

1.1.1

Contract Sum

2.2.2, 2.2.4, 3.7.4, 3.7.5, 3.8, 3.10.2, 5.2.3, 7.3, 7.4, **9.1**, 9.2, 9.4.2, 9.5.1.4, 9.6.7, 9.7, 10.3.2, 11.5, 12.1.2, 12.3, 14.2.4, 14.3.2, 15.1.4.2, **15.1.5**, **15.2.5**

Contract Sum, Definition of

9.1

Contract Time

1.1.4, 2.2.1, 2.2.2, 3.7.4, 3.7.5, 3.10.2, 5.2.3, 6.1.5, 7.2.1.3, 7.3.1, 7.3.5, 7.3.6, 7, 7, 7.3.10, 7.4, 8.1.1, 8.2.1, 8.2.3, 8.3.1, 9.5.1, 9.7, 10.3.2, 12.1.1, 12.1.2, 14.3.2, 15.1.4.2, 15.1.6.1, 15.2.5

Contract Time, Definition of

8.1.1

8.1.1

CONTRACTOR

3

Contractor, Definition of

3.1, **6.1.2**

Contractor's Construction and Submittal

Schedules

3.10, 3.12.1, 3.12.2, 4.2.3, 6.1.3, 15.1.6.2

Init.

AIA Document A201® – 2017. Copyright © 1911, 1915, 1918, 1925, 1937, 1951, 1958, 1961, 1963, 1966, 1970, 1976, 1987, 1997, 2007 and 2017 by The American Institute of Architects. All rights reserved. The "American Institute of Architects," "AIA," the AIA Logo, "A201," and "AIA Contract Documents" are registered trademarks and may not be used without permission. This document was produced by AIA software at 10:53:20 ET on 06/30/2022 under Order No.2054927631 which expires on 08/20/2022, is not for resale, is licensed for one-time use only, and may only be used in accordance with the AIA Contract Documents® Terms of Service. To report copyright violations, e-mail copyright@aia.org.

User Notes:

(1652185154)

Contractor's Employees
2.2.4, 3.3.2, 3.4.3, 3.8.1, 3.9, 3.18.2, 4.2.3, 4.2.6, 10.2,
10.3, 11.3, 14.1, 14.2.1.1

Contractor's Liability Insurance

11.1

Contractor's Relationship with Separate Contractors
and Owner's Forces

3.12.5, 3.14.2, 4.2.4, 6, 11.3, 12.2.4

Contractor's Relationship with Subcontractors

1.2.2, 2.2.4, 3.3.2, 3.18.1, 3.18.2, 4.2.4, 5, 9.6.2, 9.6.7,
9.10.2, 11.2, 11.3, 11.4

Contractor's Relationship with the Architect

1.1.2, 1.5, 2.3.3, 3.1.3, 3.2.2, 3.2.3, 3.2.4, 3.3.1, 3.4.2,
3.5.1, 3.7.4, 3.10, 3.11, 3.12, 3.16, 3.18, 4.2, 5.2, 6.2.2,
7, 8.3.1, 9.2, 9.3, 9.4, 9.5, 9.7, 9.8, 9.9, 10.2.6, 10.3,
11.3, 12, 13.4, 15.1.3, 15.2.1

Contractor's Representations

3.2.1, 3.2.2, 3.5, 3.12.6, 6.2.2, 8.2.1, 9.3.3, 9.8.2

Contractor's Responsibility for Those Performing the
Work

3.3.2, 3.18, 5.3, 6.1.3, 6.2, 9.5.1, 10.2.8

Contractor's Review of Contract Documents

3.2

Contractor's Right to Stop the Work

2.2.2, 9.7

Contractor's Right to Terminate the Contract

14.1

Contractor's Submittals

3.10, 3.11, 3.12, 4.2.7, 5.2.1, 5.2.3, 9.2, 9.3, 9.8.2,
9.8.3, 9.9.1, 9.10.2, 9.10.3

Contractor's Superintendent

3.9, 10.2.6

Contractor's Supervision and Construction

Procedures

1.2.2, 3.3, 3.4, 3.12.10, 4.2.2, 4.2.7, 6.1.3, 6.2.4, 7.1.3,
7.3.4, 7.3.6, 8.2, 10, 12, 14, 15.1.4

Coordination and Correlation

1.2, 3.2.1, 3.3.1, 3.10, 3.12.6, 6.1.3, 6.2.1

Copies Furnished of Drawings and Specifications

1.5, 2.3.6, 3.11

Copyrights

1.5, 3.17

Correction of Work

2.5, 3.7.3, 9.4.2, 9.8.2, 9.8.3, 9.9.1, 12.1.2, 12.2, 12.3,
15.1.3.1, 15.1.3.2, 15.2.1

Correlation and Intent of the Contract Documents

1.2

Cost, Definition of

7.3.4

Costs

2.5, 3.2.4, 3.7.3, 3.8.2, 3.15.2, 5.4.2, 6.1.1, 6.2.3,
7.3.3.3, 7.3.4, 7.3.8, 7.3.9, 9.10.2, 10.3.2, 10.3.6, 11.2,
12.1.2, 12.2.1, 12.2.4, 13.4, 14

Cutting and Patching

3.14, 6.2.5

**Damage to Construction of Owner or Separate
Contractors**

3.14.2, 6.2.4, 10.2.1.2, 10.2.5, 10.4, 12.2.4

Damage to the Work

3.14.2, 9.9.1, 10.2.1.2, 10.2.5, 10.4, 12.2.4

Damages, Claims for

3.2.4, 3.18, 6.1.1, 8.3.3, 9.5.1, 9.6.7, 10.3.3, 11.3.2,
11.3, 14.2.4, 15.1.7

Damages for Delay

6.2.3, 8.3.3, 9.5.1.6, 9.7, 10.3.2, 14.3.2

Date of Commencement of the Work, Definition of

8.1.2

Date of Substantial Completion, Definition of

8.1.3

Day, Definition of

8.1.4

Decisions of the Architect

3.7.4, 4.2.6, 4.2.7, 4.2.11, 4.2.12, 4.2.13, 6.3, 7.3.4,
7.3.9, 8.1.3, 8.3.1, 9.2, 9.4, 9.5.1, 9.8.4, 9.9.1, 13.4.2,
14.2.2, 14.2.4, 15.1, 15.2

Decisions to Withhold Certification

9.4.1, 9.5, 9.7, 14.1.1.3

**Defective or Nonconforming Work, Acceptance,
Rejection and Correction of**

2.5, 3.5, 4.2.6, 6.2.3, 9.5.1, 9.5.3, 9.6.6, 9.8.2, 9.9.3,
9.10.4, 12.2.1

Definitions

1.1, 2.1.1, 3.1.1, 3.5, 3.12.1, 3.12.2, 3.12.3, 4.1.1, 5.1,
6.1.2, 7.2.1, 7.3.1, 8.1, 9.1, 9.8.1, 15.1.1

Delays and Extensions of Time

**3.2, 3.7.4, 5.2.3, 7.2.1, 7.3.1, 7.4, 8.3, 9.5.1, 9.7,
10.3.2, 10.4, 14.3.2, 15.1.6, 15.2.5**

Digital Data Use and Transmission

1.7

Disputes

6.3, 7.3.9, 15.1, 15.2

Documents and Samples at the Site

3.11

Drawings, Definition of

1.1.5

Drawings and Specifications, Use and Ownership of

3.11

Effective Date of Insurance

8.2.2

Emergencies

10.4, 14.1.1.2, 15.1.5

Employees, Contractor's

3.3.2, 3.4.3, 3.8.1, 3.9, 3.18.2, 4.2.3, 4.2.6, 10.2,
10.3.3, 11.3, 14.1, 14.2.1.1

Equipment, Labor, or Materials

1.1.3, 1.1.6, 3.4, 3.5, 3.8.2, 3.8.3, 3.12, 3.13, 3.15.1,
4.2.6, 4.2.7, 5.2.1, 6.2.1, 7.3.4, 9.3.2, 9.3.3, 9.5.1.3,
9.10.2, 10.2.1, 10.2.4, 14.2.1.1, 14.2.1.2

Execution and Progress of the Work

1.1.3, 1.2.1, 1.2.2, 2.3.4, 2.3.6, 3.1, 3.3.1, 3.4.1, 3.7.1,
3.10.1, 3.12, 3.14, 4.2, 6.2.2, 7.1.3, 7.3.6, 8.2, 9.5.1,
9.9.1, 10.2, 10.3, 12.1, 12.2, 14.2, 14.3.1, 15.1.4

Init.

AIA Document A201® – 2017. Copyright © 1911, 1915, 1918, 1925, 1937, 1951, 1958, 1961, 1963, 1966, 1970, 1976, 1987, 1997, 2007 and 2017 by The American Institute of Architects. All rights reserved. The "American Institute of Architects," "AIA," the AIA Logo, "A201," and "AIA Contract Documents" are registered trademarks and may not be used without permission. This document was produced by AIA software at 10:53:20 ET on 06/30/2022 under Order No.2054927631 which expires on 08/20/2022, is not for resale, is licensed for one-time use only, and may only be used in accordance with the AIA Contract Documents® Terms of Service. To report copyright violations, e-mail copyright@aia.org.

User Notes:

(1652185154)

Extensions of Time
3.2.4, 3.7.4, 5.2.3, 7.2.1, 7.3, 7.4, 9.5.1, 9.7, 10.3.2,
10.4, 14.3, 15.1.6, **15.2.5**

Failure of Payment

9.5.1.3, **9.7**, 9.10.2, 13.5, 14.1.1.3, 14.2.1.2

Faulty Work

(See Defective or Nonconforming Work)

Final Completion and Final Payment

4.2.1, 4.2.9, 9.8.2, **9.10**, 12.3, 14.2.4, 14.4.3

Financial Arrangements, Owner's

2.2.1, 13.2.2, 14.1.1.4

GENERAL PROVISIONS

1

Governing Law

13.1

Guarantees (See Warranty)

Hazardous Materials and Substances

10.2.4, **10.3**

Identification of Subcontractors and Suppliers

5.2.1

Indemnification

3.17, **3.18**, 9.6.8, 9.10.2, 10.3.3, 11.3

Information and Services Required of the Owner

2.1.2, **2.2**, 2.3, 3.2.2, 3.12.10.1, 6.1.3, 6.1.4, 6.2.5,

9.6.1, 9.9.2, 9.10.3, 10.3.3, 11.2, 13.4.1, 13.4.2,

14.1.1.4, 14.1.4, 15.1.4

Initial Decision

15.2

Initial Decision Maker, Definition of

1.1.8

Initial Decision Maker, Decisions

14.2.4, 15.1.4.2, 15.2.1, 15.2.2, 15.2.3, 15.2.4, 15.2.5

Initial Decision Maker, Extent of Authority

14.2.4, 15.1.4.2, 15.2.1, 15.2.2, 15.2.3, 15.2.4, 15.2.5

Injury or Damage to Person or Property

10.2.8, 10.4

Inspections

3.1.3, 3.3.3, 3.7.1, 4.2.2, 4.2.6, 4.2.9, 9.4.2, 9.8.3,

9.9.2, 9.10.1, 12.2.1, 13.4

Instructions to Bidders

1.1.1

Instructions to the Contractor

3.2.4, 3.3.1, 3.8.1, 5.2.1, 7, 8.2.2, 12, 13.4.2

Instruments of Service, Definition of

1.1.7

Insurance

6.1.1, 7.3.4, 8.2.2, 9.3.2, 9.8.4, 9.9.1, 9.10.2, 10.2.5, **11**

Insurance, Notice of Cancellation or Expiration

11.1.4, 11.2.3

Insurance, Contractor's Liability

11.1

Insurance, Effective Date of

8.2.2, 14.4.2

Insurance, Owner's Liability

11.2

Insurance, Property

10.2.5, 11.2, 11.4, 11.5

Insurance, Stored Materials

9.3.2

INSURANCE AND BONDS

11

Insurance Companies, Consent to Partial Occupancy

9.9.1

Insured loss, Adjustment and Settlement of

11.5

Intent of the Contract Documents

1.2.1, 4.2.7, 4.2.12, 4.2.13

Interest

13.5

Interpretation

1.1.8, 1.2.3, **1.4**, 4.1.1, 5.1, 6.1.2, 15.1.1

Interpretations, Written

4.2.11, 4.2.12

Judgment on Final Award

15.4.2

Labor and Materials, Equipment

1.1.3, 1.1.6, **3.4**, 3.5, 3.8.2, 3.8.3, 3.12, 3.13, 3.15.1,

5.2.1, 6.2.1, 7.3.4, 9.3.2, 9.3.3, 9.5.1.3, 9.10.2, 10.2.1,

10.2.4, 14.2.1.1, 14.2.1.2

Labor Disputes

8.3.1

Laws and Regulations

1.5, 2.3.2, 3.2.3, 3.2.4, 3.6, 3.7, 3.12.10, 3.13, 9.6.4,

9.9.1, 10.2.2, 13.1, 13.3.1, 13.4.2, 13.5, 14, 15.2.8,

15.4

Liens

2.1.2, 9.3.1, 9.3.3, 9.6.8, 9.10.2, 9.10.4, 15.2.8

Limitations, Statutes of

12.2.5, 15.1.2, 15.4.1.1

Limitations of Liability

3.2.2, 3.5, 3.12.10, 3.12.10.1, 3.17, 3.18.1, 4.2.6,

4.2.7, 6.2.2, 9.4.2, 9.6.4, 9.6.7, 9.6.8, 10.2.5, 10.3.3,

11.3, 12.2.5, 13.3.1

Limitations of Time

2.1.2, 2.2, 2.5, 3.2.2, 3.10, 3.11, 3.12.5, 3.15.1, 4.2.7,

5.2, 5.3, 5.4.1, 6.2.4, 7.3, 7.4, 8.2, 9.2, 9.3.1, 9.3.3,

9.4.1, 9.5, 9.6, 9.7, 9.8, 9.9, 9.10, 12.2, 13.4, 14, 15,

15.1.2, 15.1.3, 15.1.5

Materials, Hazardous

10.2.4, **10.3**

Materials, Labor, Equipment and

1.1.3, 1.1.6, 3.4.1, 3.5, 3.8.2, 3.8.3, 3.12, 3.13, 3.15.1,

5.2.1, 6.2.1, 7.3.4, 9.3.2, 9.3.3, 9.5.1.3, 9.10.2,

10.2.1.2, 10.2.4, 14.2.1.1, 14.2.1.2

Means, Methods, Techniques, Sequences and

Procedures of Construction

3.3.1, 3.12.10, 4.2.2, 4.2.7, 9.4.2

Mechanic's Lien

2.1.2, 9.3.1, 9.3.3, 9.6.8, 9.10.2, 9.10.4, 15.2.8

Mediation

8.3.1, 15.1.3.2, 15.2.1, 15.2.5, 15.2.6, **15.3**, 15.4.1,

15.4.1.1

Minor Changes in the Work

1.1.1, 3.4.2, 3.12.8, 4.2.8, 7.1, 7.4

Init.

AIA Document A201® – 2017. Copyright © 1911, 1915, 1918, 1925, 1937, 1951, 1958, 1961, 1963, 1966, 1970, 1976, 1987, 1997, 2007 and 2017 by The American Institute of Architects. All rights reserved. The "American Institute of Architects," "AIA," the AIA Logo, "A201," and "AIA Contract Documents" are registered trademarks and may not be used without permission. This document was produced by AIA software at 10:53:20 ET on 06/30/2022 under Order No.2054927631 which expires on 08/20/2022, is not for resale, is licensed for one-time use only, and may only be used in accordance with the AIA Contract Documents® Terms of Service. To report copyright violations, e-mail copyright@aia.org.

User Notes:

(1652185154)

MISCELLANEOUS PROVISIONS

13

Modifications, Definition of

1.1.1

Modifications to the Contract

1.1.1, 1.1.2, 2.5, 3.11, 4.1.2, 4.2.1, 5.2.3, 7, 8.3.1, 9.7, 10.3.2

Mutual Responsibility

6.2

Nonconforming Work, Acceptance of

9.6.6, 9.9.3, 12.3

Nonconforming Work, Rejection and Correction of
2.4, 2.5, 3.5, 4.2.6, 6.2.4, 9.5.1, 9.8.2, 9.9.3, 9.10.4, 12.2

Notice

1.6, 1.6.1, 1.6.2, 2.1.2, 2.2.2., 2.2.3, 2.2.4, 2.5, 3.2.4, 3.3.1, 3.7.4, 3.7.5, 3.9.2, 3.12.9, 3.12.10, 5.2.1, 7.4, 8.2.2, 9.6.8, 9.7, 9.10.1, 10.2.8, 10.3.2, 11.5, 12.2.2.1, 13.4.1, 13.4.2, 14.1, 14.2.2, 14.4.2, 15.1.3, 15.1.5, 15.1.6, 15.4.1

Notice of Cancellation or Expiration of Insurance

11.1.4, 11.2.3

Notice of Claims

1.6.2, 2.1.2, 3.7.4, 9.6.8, 10.2.8, 15.1.3, 15.1.5, 15.1.6, 15.2.8, 15.3.2, 15.4.1

Notice of Testing and Inspections

13.4.1, 13.4.2

Observations, Contractor's

3.2, 3.7.4

Occupancy

2.3.1, 9.6.6, 9.8

Orders, Written

1.1.1, 2.4, 3.9.2, 7, 8.2.2, 11.5, 12.1, 12.2.2.1, 13.4.2, 14.3.1

OWNER

2

Owner, Definition of

2.1.1

Owner, Evidence of Financial Arrangements

2.2, 13.2.2, 14.1.1.4

Owner, Information and Services Required of the

2.1.2, 2.2, 2.3, 3.2.2, 3.12.10, 6.1.3, 6.1.4, 6.2.5, 9.3.2, 9.6.1, 9.6.4, 9.9.2, 9.10.3, 10.3.3, 11.2, 13.4.1, 13.4.2, 14.1.1.4, 14.1.4, 15.1.4

Owner's Authority

1.5, 2.1.1, 2.3.32.4, 2.5, 3.4.2, 3.8.1, 3.12.10, 3.14.2, 4.1.2, 4.2.4, 4.2.9, 5.2.1, 5.2.4, 5.4.1, 6.1, 6.3, 7.2.1, 7.3.1, 8.2.2, 8.3.1, 9.3.2, 9.5.1, 9.6.4, 9.9.1, 9.10.2, 10.3.2, 11.4, 11.5, 12.2.2, 12.3, 13.2.2, 14.3, 14.4, 15.2.7

Owner's Insurance

11.2

Owner's Relationship with Subcontractors

1.1.2, 5.2, 5.3, 5.4, 9.6.4, 9.10.2, 14.2.2

Owner's Right to Carry Out the Work

2.5, 14.2.2

Owner's Right to Clean Up

6.3

Owner's Right to Perform Construction and to Award Separate Contracts

6.1

Owner's Right to Stop the Work

2.4

Owner's Right to Suspend the Work

14.3

Owner's Right to Terminate the Contract

14.2, 14.4

Ownership and Use of Drawings, Specifications and Other Instruments of Service

1.1.1, 1.1.6, 1.1.7, 1.5, 2.3.6, 3.2.2, 3.11, 3.17, 4.2.12, 5.3

Partial Occupancy or Use

9.6.6, 9.9

Patching, Cutting and

3.14, 6.2.5

Patents

3.17

Payment, Applications for

4.2.5, 7.3.9, 9.2, 9.3, 9.4, 9.5, 9.6.3, 9.7, 9.8.5, 9.10.1, 14.2.3, 14.2.4, 14.4.3

Payment, Certificates for

4.2.5, 4.2.9, 9.3.3, 9.4, 9.5, 9.6.1, 9.6.6, 9.7, 9.10.1, 9.10.3, 14.1.1.3, 14.2.4

Payment, Failure of

9.5.1.3, 9.7, 9.10.2, 13.5, 14.1.1.3, 14.2.1.2

Payment, Final

4.2.1, 4.2.9, 9.10, 12.3, 14.2.4, 14.4.3

Payment Bond, Performance Bond and

7.3.4.4, 9.6.7, 9.10.3, 11.1.2

Payments, Progress

9.3, 9.6, 9.8.5, 9.10.3, 14.2.3, 15.1.4

PAYMENTS AND COMPLETION

9

Payments to Subcontractors

5.4.2, 9.5.1.3, 9.6.2, 9.6.3, 9.6.4, 9.6.7, 14.2.1.2

PCB

10.3.1

Performance Bond and Payment Bond

7.3.4.4, 9.6.7, 9.10.3, 11.1.2

Permits, Fees, Notices and Compliance with Laws

2.3.1, 3.7, 3.13, 7.3.4.4, 10.2.2

PERSONS AND PROPERTY, PROTECTION OF

10

Polychlorinated Biphenyl

10.3.1

Product Data, Definition of

3.12.2

Product Data and Samples, Shop Drawings

3.11, 3.12, 4.2.7

Progress and Completion

4.2.2, 8.2, 9.8, 9.9.1, 14.1.4, 15.1.4

Progress Payments

9.3, 9.6, 9.8.5, 9.10.3, 14.2.3, 15.1.4

Init.

AIA Document A201® – 2017. Copyright © 1911, 1915, 1918, 1925, 1937, 1951, 1958, 1961, 1963, 1966, 1970, 1976, 1987, 1997, 2007 and 2017 by The American Institute of Architects. All rights reserved. The "American Institute of Architects," "AIA," the AIA Logo, "A201," and "AIA Contract Documents" are registered trademarks and may not be used without permission. This document was produced by AIA software at 10:53:20 ET on 06/30/2022 under Order No.2054927631 which expires on 08/20/2022, is not for resale, is licensed for one-time use only, and may only be used in accordance with the AIA Contract Documents® Terms of Service. To report copyright violations, e-mail copyright@aia.org.

User Notes:

(1652185154)

Project, Definition of
1.1.4
Project Representatives
4.2.10
Property Insurance
10.2.5, **11.2**
Proposal Requirements
1.1.1
PROTECTION OF PERSONS AND PROPERTY
10
Regulations and Laws
1.5, 2.3.2, 3.2.3, 3.6, 3.7, 3.12.10, 3.13, 9.6.4, 9.9.1,
10.2.2, 13.1, 13.3, 13.4.1, 13.4.2, 13.5, 14, 15.2.8, 15.4
Rejection of Work
4.2.6, 12.2.1
Releases and Waivers of Liens
9.3.1, 9.10.2
Representations
3.2.1, 3.5, 3.12.6, 8.2.1, 9.3.3, 9.4.2, 9.5.1, 9.10.1
Representatives
2.1.1, 3.1.1, 3.9, 4.1.1, 4.2.10, 13.2.1
Responsibility for Those Performing the Work
3.3.2, 3.18, 4.2.2, 4.2.3, 5.3, 6.1.3, 6.2, 6.3, 9.5.1, 10
Retainage
9.3.1, 9.6.2, 9.8.5, 9.9.1, 9.10.2, 9.10.3
Review of Contract Documents and Field
Conditions by Contractor
3.2, 3.12.7, 6.1.3
Review of Contractor's Submittals by Owner and
Architect
3.10.1, 3.10.2, 3.11, 3.12, 4.2, 5.2, 6.1.3, 9.2, 9.8.2
Review of Shop Drawings, Product Data and Samples
by Contractor
3.12
Rights and Remedies
1.1.2, 2.4, 2.5, 3.5, 3.7.4, 3.15.2, 4.2.6, 5.3, 5.4, 6.1,
6.3, 7.3.1, 8.3, 9.5.1, 9.7, 10.2.5, 10.3, 12.2.1, 12.2.2,
12.2.4, **13.3**, 14, 15.4
Royalties, Patents and Copyrights
3.17
Rules and Notices for Arbitration
15.4.1
Safety of Persons and Property
10.2, 10.4
Safety Precautions and Programs
3.3.1, 4.2.2, 4.2.7, 5.3, **10.1**, 10.2, 10.4
Samples, Definition of
3.12.3
Samples, Shop Drawings, Product Data and
3.11, **3.12**, 4.2.7
Samples at the Site, Documents and
3.11
Schedule of Values
9.2, 9.3.1
Schedules, Construction
3.10, 3.12.1, 3.12.2, 6.1.3, 15.1.6.2

Separate Contracts and Contractors
1.1.4, 3.12.5, 3.14.2, 4.2.4, 4.2.7, 6, 8.3.1, 12.1.2
Separate Contractors, Definition of
6.1.1
Shop Drawings, Definition of
3.12.1
Shop Drawings, Product Data and Samples
3.11, **3.12**, 4.2.7
Site, Use of
3.13, 6.1.1, 6.2.1
Site Inspections
3.2.2, 3.3.3, 3.7.1, 3.7.4, 4.2, 9.9.2, 9.4.2, 9.10.1, 13.4
Site Visits, Architect's
3.7.4, 4.2.2, 4.2.9, 9.4.2, 9.5.1, 9.9.2, 9.10.1, 13.4
Special Inspections and Testing
4.2.6, 12.2.1, 13.4
Specifications, Definition of
1.1.6
Specifications
1.1.1, **1.1.6**, 1.2.2, 1.5, 3.12.10, 3.17, 4.2.14
Statute of Limitations
15.1.2, 15.4.1.1
Stopping the Work
2.2.2, 2.4, 9.7, 10.3, 14.1
Stored Materials
6.2.1, 9.3.2, 10.2.1.2, 10.2.4
Subcontractor, Definition of
5.1.1
SUBCONTRACTORS
5
Subcontractors, Work by
1.2.2, 3.3.2, 3.12.1, 3.18, 4.2.3, 5.2.3, 5.3, 5.4, 9.3.1.2,
9.6.7
Subcontractual Relations
5.3, 5.4, 9.3.1.2, 9.6, 9.10, 10.2.1, 14.1, 14.2.1
Submittals
3.10, 3.11, 3.12, 4.2.7, 5.2.1, 5.2.3, 7.3.4, 9.2, 9.3, 9.8,
9.9.1, 9.10.2, 9.10.3
Submittal Schedule
3.10.2, 3.12.5, 4.2.7
Subrogation, Waivers of
6.1.1, **11.3**
Substances, Hazardous
10.3
Substantial Completion
4.2.9, 8.1.1, 8.1.3, 8.2.3, 9.4.2, **9.8**, 9.9.1, 9.10.3, 12.2,
15.1.2
Substantial Completion, Definition of
9.8.1
Substitution of Subcontractors
5.2.3, 5.2.4
Substitution of Architect
2.3.3
Substitutions of Materials
3.4.2, 3.5, 7.3.8
Sub-subcontractor, Definition of
5.1.2

Init.

Subsurface Conditions
3.7.4

Successors and Assigns
13.2

Superintendent
3.9, 10.2.6

Supervision and Construction Procedures
1.2.2, **3.3**, 3.4, 3.12.10, 4.2.2, 4.2.7, 6.1.3, 6.2.4, 7.1.3,
7.3.4, 8.2, 8.3.1, 9.4.2, 10, 12, 14, 15.1.4

Suppliers
1.5, 3.12.1, 4.2.4, 4.2.6, 5.2.1, 9.3, 9.4.2, 9.5.4, 9.6,
9.10.5, 14.2.1

Surety
5.4.1.2, 9.6.8, 9.8.5, 9.10.2, 9.10.3, 11.1.2, 14.2.2,
15.2.7

Surety, Consent of
9.8.5, 9.10.2, 9.10.3

Surveys
1.1.7, 2.3.4

Suspension by the Owner for Convenience
14.3

Suspension of the Work
3.7.5, 5.4.2, 14.3

Suspension or Termination of the Contract
5.4.1.1, 14

Taxes
3.6, 3.8.2.1, 7.3.4.4

Termination by the Contractor
14.1, 15.1.7

Termination by the Owner for Cause
5.4.1.1, **14.2**, 15.1.7

Termination by the Owner for Convenience
14.4

Termination of the Architect
2.3.3

Termination of the Contractor Employment
14.2.2

TERMINATION OR SUSPENSION OF THE CONTRACT
14

Tests and Inspections
3.1.3, 3.3.3, 3.7.1, 4.2.2, 4.2.6, 4.2.9, 9.4.2, 9.8.3,
9.9.2, 9.10.1, 10.3.2, 12.2.1, **13.4**

TIME
8

Time, Delays and Extensions of
3.2.4, 3.7.4, 5.2.3, 7.2.1, 7.3.1, 7.4, **8.3**, 9.5.1, 9.7,
10.3.2, 10.4, 14.3.2, 15.1.6, 15.2.5

Time Limits
2.1.2, 2.2, 2.5, 3.2.2, 3.10, 3.11, 3.12.5, 3.15.1, 4.2,
5.2, 5.3, 5.4, 6.2.4, 7.3, 7.4, 8.2, 9.2, 9.3.1, 9.3.3, 9.4.1,
9.5, 9.6, 9.7, 9.8, 9.9, 9.10, 12.2, 13.4, 14, 15.1.2,
15.1.3, 15.4

Time Limits on Claims
3.7.4, 10.2.8, 15.1.2, 15.1.3

Title to Work
9.3.2, 9.3.3

UNCOVERING AND CORRECTION OF WORK
12

Uncovering of Work
12.1

Unforeseen Conditions, Concealed or Unknown
3.7.4, 8.3.1, 10.3

Unit Prices
7.3.3.2, 9.1.2

Use of Documents
1.1.1, 1.5, 2.3.6, 3.12.6, 5.3

Use of Site
3.13, 6.1.1, 6.2.1

Values, Schedule of
9.2, 9.3.1

Waiver of Claims by the Architect
13.3.2

Waiver of Claims by the Contractor
9.10.5, 13.3.2, **15.1.7**

Waiver of Claims by the Owner
9.9.3, 9.10.3, 9.10.4, 12.2.2.1, 13.3.2, 14.2.4, **15.1.7**

Waiver of Consequential Damages
14.2.4, 15.1.7

Waiver of Liens
9.3, 9.10.2, 9.10.4

Waivers of Subrogation
6.1.1, **11.3**

Warranty
3.5, 4.2.9, 9.3.3, 9.8.4, 9.9.1, 9.10.2, 9.10.4, 12.2.2,
15.1.2

Weather Delays
8.3, 15.1.6.2

Work, Definition of
1.1.3

Written Consent
1.5.2, 3.4.2, 3.7.4, 3.12.8, 3.14.2, 4.1.2, 9.3.2, 9.10.3,
13.2, 13.3.2, 15.4.4.2

Written Interpretations
4.2.11, 4.2.12

Written Orders
1.1.1, 2.4, 3.9, 7, 8.2.2, 12.1, 12.2, 13.4.2, 14.3.1

ARTICLE 1 GENERAL PROVISIONS

§ 1.1 Basic Definitions

§ 1.1.1 The Contract Documents

The Contract Documents are enumerated in the Agreement between the Owner and Contractor (hereinafter the Agreement) and consist of the Agreement, Conditions of the Contract (General, Supplementary and other Conditions), Drawings, Specifications, Addenda issued prior to execution of the Contract, other documents listed in the Agreement, and Modifications issued after execution of the Contract. A Modification is (1) a written amendment to the Contract signed by both parties, (2) a Change Order, (3) a Construction Change Directive, or (4) a written order for a minor change in the Work issued by the Architect. Unless specifically enumerated in the Agreement, the Contract Documents do not include the advertisement or invitation to bid, Instructions to Bidders, sample forms, other information furnished by the Owner in anticipation of receiving bids or proposals, the Contractor's bid or proposal, or portions of Addenda relating to bidding or proposal requirements.

§ 1.1.2 The Contract

The Contract Documents form the Contract for Construction. The Contract represents the entire and integrated agreement between the parties hereto and supersedes prior negotiations, representations, or agreements, either written or oral. The Contract may be amended or modified only by a Modification. The Contract Documents shall not be construed to create a contractual relationship of any kind (1) between the Contractor and the Architect or the Architect's consultants, (2) between the Owner and a Subcontractor or a Sub-subcontractor, (3) between the Owner and the Architect or the Architect's consultants, or (4) between any persons or entities other than the Owner and the Contractor. The Architect shall, however, be entitled to performance and enforcement of obligations under the Contract intended to facilitate performance of the Architect's duties.

§ 1.1.3 The Work

The term "Work" means the construction and services required by the Contract Documents, whether completed or partially completed, and includes all other labor, materials, equipment, and services provided or to be provided by the Contractor to fulfill the Contractor's obligations. The Work may constitute the whole or a part of the Project.

§ 1.1.4 The Project

The Project is the total construction of which the Work performed under the Contract Documents may be the whole or a part and which may include construction by the Owner and by Separate Contractors.

§ 1.1.5 The Drawings

The Drawings are the graphic and pictorial portions of the Contract Documents showing the design, location and dimensions of the Work, generally including plans, elevations, sections, details, schedules, and diagrams.

§ 1.1.6 The Specifications

The Specifications are that portion of the Contract Documents consisting of the written requirements for materials, equipment, systems, standards and workmanship for the Work, and performance of related services.

§ 1.1.7 Instruments of Service

Instruments of Service are representations, in any medium of expression now known or later developed, of the tangible and intangible creative work performed by the Architect and the Architect's consultants under their respective professional services agreements. Instruments of Service may include, without limitation, studies, surveys, models, sketches, drawings, specifications, and other similar materials.

§ 1.1.8 Initial Decision Maker

The Initial Decision Maker is the person identified in the Agreement to render initial decisions on Claims in accordance with Section 15.2. The Initial Decision Maker shall not show partiality to the Owner or Contractor and shall not be liable for results of interpretations or decisions rendered in good faith.

§ 1.2 Correlation and Intent of the Contract Documents

§ 1.2.1 The intent of the Contract Documents is to include all items necessary for the proper execution and completion of the Work by the Contractor. The Contract Documents are complementary, and what is required by one shall be as binding as if required by all; performance by the Contractor shall be required only to the extent consistent with the Contract Documents and reasonably inferable from them as being necessary to produce the indicated results.

§ 1.2.1.1 The invalidity of any provision of the Contract Documents shall not invalidate the Contract or its remaining provisions. If it is determined that any provision of the Contract Documents violates any law, or is otherwise invalid or unenforceable, then that provision shall be revised to the extent necessary to make that provision legal and enforceable. In such case the Contract Documents shall be construed, to the fullest extent permitted by law, to give effect to the parties' intentions and purposes in executing the Contract.

§ 1.2.2 Organization of the Specifications into divisions, sections and articles, and arrangement of Drawings shall not control the Contractor in dividing the Work among Subcontractors or in establishing the extent of Work to be performed by any trade.

§ 1.2.3 Unless otherwise stated in the Contract Documents, words that have well-known technical or construction industry meanings are used in the Contract Documents in accordance with such recognized meanings.

§ 1.3 Capitalization

Terms capitalized in these General Conditions include those that are (1) specifically defined, (2) the titles of numbered articles, or (3) the titles of other documents published by the American Institute of Architects.

§ 1.4 Interpretation

In the interest of brevity the Contract Documents frequently omit modifying words such as "all" and "any" and articles such as "the" and "an," but the fact that a modifier or an article is absent from one statement and appears in another is not intended to affect the interpretation of either statement.

§ 1.5 Ownership and Use of Drawings, Specifications, and Other Instruments of Service

§ 1.5.1 The Architect and the Architect's consultants shall be deemed the authors and owners of their respective Instruments of Service, including the Drawings and Specifications, and retain all common law, statutory, and other reserved rights in their Instruments of Service, including copyrights. The Contractor, Subcontractors, Sub-subcontractors, and suppliers shall not own or claim a copyright in the Instruments of Service. Submittal or distribution to meet official regulatory requirements or for other purposes in connection with the Project is not to be construed as publication in derogation of the Architect's or Architect's consultants' reserved rights.

§ 1.5.2 The Contractor, Subcontractors, Sub-subcontractors, and suppliers are authorized to use and reproduce the Instruments of Service provided to them, subject to any protocols established pursuant to Sections 1.7 and 1.8, solely and exclusively for execution of the Work. All copies made under this authorization shall bear the copyright notice, if any, shown on the Instruments of Service. The Contractor, Subcontractors, Sub-subcontractors, and suppliers may not use the Instruments of Service on other projects or for additions to the Project outside the scope of the Work without the specific written consent of the Owner, Architect, and the Architect's consultants.

§ 1.6 Notice

§ 1.6.1 Except as otherwise provided in Section 1.6.2, where the Contract Documents require one party to notify or give notice to the other party, such notice shall be provided in writing to the designated representative of the party to whom the notice is addressed and shall be deemed to have been duly served if delivered in person, by mail, by courier, or by electronic transmission if a method for electronic transmission is set forth in the Agreement.

§ 1.6.2 Notice of Claims as provided in Section 15.1.3 shall be provided in writing and shall be deemed to have been duly served only if delivered to the designated representative of the party to whom the notice is addressed by certified or registered mail, or by courier providing proof of delivery.

§ 1.7 Digital Data Use and Transmission

The parties shall agree upon protocols governing the transmission and use of Instruments of Service or any other information or documentation in digital form. The parties will use AIA Document E203™-2013, Building Information Modeling and Digital Data Exhibit, to establish the protocols for the development, use, transmission, and exchange of digital data.

§ 1.8 Building Information Models Use and Reliance

Any use of, or reliance on, all or a portion of a building information model without agreement to protocols governing the use of, and reliance on, the information contained in the model and without having those protocols set forth in AIA Document E203™-2013, Building Information Modeling and Digital Data Exhibit, and the requisite AIA Document

Init.

AIA Document A201® – 2017. Copyright © 1911, 1915, 1918, 1925, 1937, 1951, 1958, 1961, 1963, 1966, 1970, 1976, 1987, 1997, 2007 and 2017 by The American Institute of Architects. All rights reserved. The "American Institute of Architects," "AIA," the AIA Logo, "A201," and "AIA Contract Documents" are registered trademarks and may not be used without permission. This document was produced by AIA software at 10:53:20 ET on 06/30/2022 under Order No.2054927631 which expires on 08/20/2022, is not for resale, is licensed for one-time use only, and may only be used in accordance with the AIA Contract Documents® Terms of Service. To report copyright violations, e-mail copyright@aia.org.

User Notes:

(1652185154)

G202™–2013, Project Building Information Modeling Protocol Form, shall be at the using or relying party's sole risk and without liability to the other party and its contractors or consultants, the authors of, or contributors to, the building information model, and each of their agents and employees.

ARTICLE 2 OWNER

§ 2.1 General

§ 2.1.1 The Owner is the person or entity identified as such in the Agreement and is referred to throughout the Contract Documents as if singular in number. The Owner shall designate in writing a representative who shall have express authority to bind the Owner with respect to all matters requiring the Owner's approval or authorization. Except as otherwise provided in Section 4.2.1, the Architect does not have such authority. The term "Owner" means the Owner or the Owner's authorized representative.

§ 2.1.2 The Owner shall furnish to the Contractor, within fifteen days after receipt of a written request, information necessary and relevant for the Contractor to evaluate, give notice of, or enforce mechanic's lien rights. Such information shall include a correct statement of the record legal title to the property on which the Project is located, usually referred to as the site, and the Owner's interest therein.

§ 2.2 Evidence of the Owner's Financial Arrangements

§ 2.2.1 Prior to commencement of the Work and upon written request by the Contractor, the Owner shall furnish to the Contractor reasonable evidence that the Owner has made financial arrangements to fulfill the Owner's obligations under the Contract. The Contractor shall have no obligation to commence the Work until the Owner provides such evidence. If commencement of the Work is delayed under this Section 2.2.1, the Contract Time shall be extended appropriately.

§ 2.2.2 Following commencement of the Work and upon written request by the Contractor, the Owner shall furnish to the Contractor reasonable evidence that the Owner has made financial arrangements to fulfill the Owner's obligations under the Contract only if (1) the Owner fails to make payments to the Contractor as the Contract Documents require; (2) the Contractor identifies in writing a reasonable concern regarding the Owner's ability to make payment when due; or (3) a change in the Work materially changes the Contract Sum. If the Owner fails to provide such evidence, as required, within fourteen days of the Contractor's request, the Contractor may immediately stop the Work and, in that event, shall notify the Owner that the Work has stopped. However, if the request is made because a change in the Work materially changes the Contract Sum under (3) above, the Contractor may immediately stop only that portion of the Work affected by the change until reasonable evidence is provided. If the Work is stopped under this Section 2.2.2, the Contract Time shall be extended appropriately and the Contract Sum shall be increased by the amount of the Contractor's reasonable costs of shutdown, delay and start-up, plus interest as provided in the Contract Documents.

§ 2.2.3 After the Owner furnishes evidence of financial arrangements under this Section 2.2, the Owner shall not materially vary such financial arrangements without prior notice to the Contractor.

§ 2.2.4 Where the Owner has designated information furnished under this Section 2.2 as "confidential," the Contractor shall keep the information confidential and shall not disclose it to any other person. However, the Contractor may disclose "confidential" information, after seven (7) days' notice to the Owner, where disclosure is required by law, including a subpoena or other form of compulsory legal process issued by a court or governmental entity, or by court or arbitrator(s) order. The Contractor may also disclose "confidential" information to its employees, consultants, sureties, Subcontractors and their employees, Sub-subcontractors, and others who need to know the content of such information solely and exclusively for the Project and who agree to maintain the confidentiality of such information.

§ 2.3 Information and Services Required of the Owner

§ 2.3.1 Except for permits and fees that are the responsibility of the Contractor under the Contract Documents, including those required under Section 3.7.1, the Owner shall secure and pay for necessary approvals, easements, assessments and charges required for construction, use or occupancy of permanent structures or for permanent changes in existing facilities.

§ 2.3.2 The Owner shall retain an architect lawfully licensed to practice architecture, or an entity lawfully practicing architecture, in the jurisdiction where the Project is located. That person or entity is identified as the Architect in the Agreement and is referred to throughout the Contract Documents as if singular in number.

Init.

§ 2.3.3 If the employment of the Architect terminates, the Owner shall employ a successor to whom the Contractor has no reasonable objection and whose status under the Contract Documents shall be that of the Architect.

§ 2.3.4 The Owner shall furnish surveys describing physical characteristics, legal limitations and utility locations for the site of the Project, and a legal description of the site. The Contractor shall be entitled to rely on the accuracy of information furnished by the Owner but shall exercise proper precautions relating to the safe performance of the Work.

§ 2.3.5 The Owner shall furnish information or services required of the Owner by the Contract Documents with reasonable promptness. The Owner shall also furnish any other information or services under the Owner's control and relevant to the Contractor's performance of the Work with reasonable promptness after receiving the Contractor's written request for such information or services.

§ 2.3.6 Unless otherwise provided in the Contract Documents, the Owner shall furnish to the Contractor one copy of the Contract Documents for purposes of making reproductions pursuant to Section 1.5.2.

§ 2.4 Owner's Right to Stop the Work

If the Contractor fails to correct Work that is not in accordance with the requirements of the Contract Documents as required by Section 1.2.2 or repeatedly fails to carry out Work in accordance with the Contract Documents, the Owner may issue a written order to the Contractor to stop the Work, or any portion thereof, until the cause for such order has been eliminated; however, the right of the Owner to stop the Work shall not give rise to a duty on the part of the Owner to exercise this right for the benefit of the Contractor or any other person or entity, except to the extent required by Section 6.1.3.

§ 2.5 Owner's Right to Carry Out the Work

If the Contractor defaults or neglects to carry out the Work in accordance with the Contract Documents and fails within a ten-day period after receipt of notice from the Owner to commence and continue correction of such default or neglect with diligence and promptness, the Owner may, without prejudice to other remedies the Owner may have, correct such default or neglect. Such action by the Owner and amounts charged to the Contractor are both subject to prior approval of the Architect and the Architect may, pursuant to Section 9.5.1, withhold or nullify a Certificate for Payment in whole or in part, to the extent reasonably necessary to reimburse the Owner for the reasonable cost of correcting such deficiencies, including Owner's expenses and compensation for the Architect's additional services made necessary by such default, neglect, or failure. If current and future payments are not sufficient to cover such amounts, the Contractor shall pay the difference to the Owner. If the Contractor disagrees with the actions of the Owner or the Architect, or the amounts claimed as costs to the Owner, the Contractor may file a Claim pursuant to Article 15.

ARTICLE 3 CONTRACTOR

§ 3.1 General

§ 3.1.1 The Contractor is the person or entity identified as such in the Agreement and is referred to throughout the Contract Documents as if singular in number. The Contractor shall be lawfully licensed, if required in the jurisdiction where the Project is located. The Contractor shall designate in writing a representative who shall have express authority to bind the Contractor with respect to all matters under this Contract. The term "Contractor" means the Contractor or the Contractor's authorized representative.

§ 3.1.2 The Contractor shall perform the Work in accordance with the Contract Documents.

§ 3.1.3 The Contractor shall not be relieved of its obligations to perform the Work in accordance with the Contract Documents either by activities or duties of the Architect in the Architect's administration of the Contract, or by tests, inspections or approvals required or performed by persons or entities other than the Contractor.

§ 3.2 Review of Contract Documents and Field Conditions by Contractor

§ 3.2.1 Execution of the Contract by the Contractor is a representation that the Contractor has visited the site, become generally familiar with local conditions under which the Work is to be performed, and correlated personal observations with requirements of the Contract Documents.

Init.

§ 3.2.2 Because the Contract Documents are complementary, the Contractor shall, before starting each portion of the Work, carefully study and compare the various Contract Documents relative to that portion of the Work, as well as the information furnished by the Owner pursuant to Section 2.3.4, shall take field measurements of any existing conditions related to that portion of the Work, and shall observe any conditions at the site affecting it. These obligations are for the purpose of facilitating coordination and construction by the Contractor and are not for the purpose of discovering errors, omissions, or inconsistencies in the Contract Documents; however, the Contractor shall promptly report to the Architect any errors, inconsistencies or omissions discovered by or made known to the Contractor as a request for information in such form as the Architect may require. It is recognized that the Contractor's review is made in the Contractor's capacity as a contractor and not as a licensed design professional, unless otherwise specifically provided in the Contract Documents.

§ 3.2.3 The Contractor is not required to ascertain that the Contract Documents are in accordance with applicable laws, statutes, ordinances, codes, rules and regulations, or lawful orders of public authorities, but the Contractor shall promptly report to the Architect any nonconformity discovered by or made known to the Contractor as a request for information in such form as the Architect may require.

§ 3.2.4 If the Contractor believes that additional cost or time is involved because of clarifications or instructions the Architect issues in response to the Contractor's notices or requests for information pursuant to Sections 3.2.2 or 3.2.3, the Contractor shall submit Claims as provided in Article 15. If the Contractor fails to perform the obligations of Sections 3.2.2 or 3.2.3, the Contractor shall pay such costs and damages to the Owner, subject to Section 15.1.7, as would have been avoided if the Contractor had performed such obligations. If the Contractor performs those obligations, the Contractor shall not be liable to the Owner or Architect for damages resulting from errors, inconsistencies or omissions in the Contract Documents, for differences between field measurements or conditions and the Contract Documents, or for nonconformities of the Contract Documents to applicable laws, statutes, ordinances, codes, rules and regulations, and lawful orders of public authorities.

§ 3.3 Supervision and Construction Procedures

§ 3.3.1 The Contractor shall supervise and direct the Work, using the Contractor's best skill and attention. The Contractor shall be solely responsible for, and have control over, construction means, methods, techniques, sequences, and procedures, and for coordinating all portions of the Work under the Contract. If the Contract Documents give specific instructions concerning construction means, methods, techniques, sequences, or procedures, the Contractor shall evaluate the jobsite safety thereof and shall be solely responsible for the jobsite safety of such means, methods, techniques, sequences, or procedures. If the Contractor determines that such means, methods, techniques, sequences or procedures may not be safe, the Contractor shall give timely notice to the Owner and Architect, and shall propose alternative means, methods, techniques, sequences, or procedures. The Architect shall evaluate the proposed alternative solely for conformance with the design intent for the completed construction. Unless the Architect objects to the Contractor's proposed alternative, the Contractor shall perform the Work using its alternative means, methods, techniques, sequences, or procedures.

§ 3.3.2 The Contractor shall be responsible to the Owner for acts and omissions of the Contractor's employees, Subcontractors and their agents and employees, and other persons or entities performing portions of the Work for, or on behalf of, the Contractor or any of its Subcontractors.

§ 3.3.3 The Contractor shall be responsible for inspection of portions of Work already performed to determine that such portions are in proper condition to receive subsequent Work.

§ 3.4 Labor and Materials

§ 3.4.1 Unless otherwise provided in the Contract Documents, the Contractor shall provide and pay for labor, materials, equipment, tools, construction equipment and machinery, water, heat, utilities, transportation, and other facilities and services necessary for proper execution and completion of the Work, whether temporary or permanent and whether or not incorporated or to be incorporated in the Work.

§ 3.4.2 Except in the case of minor changes in the Work approved by the Architect in accordance with Section 3.12.8 or ordered by the Architect in accordance with Section 7.4, the Contractor may make substitutions only with the consent of the Owner, after evaluation by the Architect and in accordance with a Change Order or Construction Change Directive.

§ 3.4.3 The Contractor shall enforce strict discipline and good order among the Contractor's employees and other persons carrying out the Work. The Contractor shall not permit employment of unfit persons or persons not properly skilled in tasks assigned to them.

§ 3.5 Warranty

§ 3.5.1 The Contractor warrants to the Owner and Architect that materials and equipment furnished under the Contract will be of good quality and new unless the Contract Documents require or permit otherwise. The Contractor further warrants that the Work will conform to the requirements of the Contract Documents and will be free from defects, except for those inherent in the quality of the Work the Contract Documents require or permit. Work, materials, or equipment not conforming to these requirements may be considered defective. The Contractor's warranty excludes remedy for damage or defect caused by abuse, alterations to the Work not executed by the Contractor, improper or insufficient maintenance, improper operation, or normal wear and tear and normal usage. If required by the Architect, the Contractor shall furnish satisfactory evidence as to the kind and quality of materials and equipment.

§ 3.5.2 All material, equipment, or other special warranties required by the Contract Documents shall be issued in the name of the Owner, or shall be transferable to the Owner, and shall commence in accordance with Section 9.8.4.

§ 3.6 Taxes

The Contractor shall pay sales, consumer, use and similar taxes for the Work provided by the Contractor that are legally enacted when bids are received or negotiations concluded, whether or not yet effective or merely scheduled to go into effect.

§ 3.7 Permits, Fees, Notices and Compliance with Laws

§ 3.7.1 Unless otherwise provided in the Contract Documents, the Contractor shall secure and pay for the building permit as well as for other permits, fees, licenses, and inspections by government agencies necessary for proper execution and completion of the Work that are customarily secured after execution of the Contract and legally required at the time bids are received or negotiations concluded.

§ 3.7.2 The Contractor shall comply with and give notices required by applicable laws, statutes, ordinances, codes, rules and regulations, and lawful orders of public authorities applicable to performance of the Work.

§ 3.7.3 If the Contractor performs Work knowing it to be contrary to applicable laws, statutes, ordinances, codes, rules and regulations, or lawful orders of public authorities, the Contractor shall assume appropriate responsibility for such Work and shall bear the costs attributable to correction.

§ 3.7.4 Concealed or Unknown Conditions

If the Contractor encounters conditions at the site that are (1) subsurface or otherwise concealed physical conditions that differ materially from those indicated in the Contract Documents or (2) unknown physical conditions of an unusual nature that differ materially from those ordinarily found to exist and generally recognized as inherent in construction activities of the character provided for in the Contract Documents, the Contractor shall promptly provide notice to the Owner and the Architect before conditions are disturbed and in no event later than 14 days after first observance of the conditions. The Architect will promptly investigate such conditions and, if the Architect determines that they differ materially and cause an increase or decrease in the Contractor's cost of, or time required for, performance of any part of the Work, will recommend that an equitable adjustment be made in the Contract Sum or Contract Time, or both. If the Architect determines that the conditions at the site are not materially different from those indicated in the Contract Documents and that no change in the terms of the Contract is justified, the Architect shall promptly notify the Owner and Contractor, stating the reasons. If either party disputes the Architect's determination or recommendation, that party may submit a Claim as provided in Article 15.

§ 3.7.5 If, in the course of the Work, the Contractor encounters human remains or recognizes the existence of burial markers, archaeological sites or wetlands not indicated in the Contract Documents, the Contractor shall immediately suspend any operations that would affect them and shall notify the Owner and Architect. Upon receipt of such notice, the Owner shall promptly take any action necessary to obtain governmental authorization required to resume the operations. The Contractor shall continue to suspend such operations until otherwise instructed by the Owner but shall continue with all other operations that do not affect those remains or features. Requests for adjustments in the Contract Sum and Contract Time arising from the existence of such remains or features may be made as provided in Article 15.

Init.

§ 3.8 Allowances

§ 3.8.1 The Contractor shall include in the Contract Sum all allowances stated in the Contract Documents. Items covered by allowances shall be supplied for such amounts and by such persons or entities as the Owner may direct, but the Contractor shall not be required to employ persons or entities to whom the Contractor has reasonable objection.

§ 3.8.2 Unless otherwise provided in the Contract Documents,

- .1 allowances shall cover the cost to the Contractor of materials and equipment delivered at the site and all required taxes, less applicable trade discounts;
- .2 Contractor's costs for unloading and handling at the site, labor, installation costs, overhead, profit, and other expenses contemplated for stated allowance amounts shall be included in the Contract Sum but not in the allowances; and
- .3 whenever costs are more than or less than allowances, the Contract Sum shall be adjusted accordingly by Change Order. The amount of the Change Order shall reflect (1) the difference between actual costs and the allowances under Section 3.8.2.1 and (2) changes in Contractor's costs under Section 3.8.2.2.

§ 3.8.3 Materials and equipment under an allowance shall be selected by the Owner with reasonable promptness.

§ 3.9 Superintendent

§ 3.9.1 The Contractor shall employ a competent superintendent and necessary assistants who shall be in attendance at the Project site during performance of the Work. The superintendent shall represent the Contractor, and communications given to the superintendent shall be as binding as if given to the Contractor.

§ 3.9.2 The Contractor, as soon as practicable after award of the Contract, shall notify the Owner and Architect of the name and qualifications of a proposed superintendent. Within 14 days of receipt of the information, the Architect may notify the Contractor, stating whether the Owner or the Architect (1) has reasonable objection to the proposed superintendent or (2) requires additional time for review. Failure of the Architect to provide notice within the 14-day period shall constitute notice of no reasonable objection.

§ 3.9.3 The Contractor shall not employ a proposed superintendent to whom the Owner or Architect has made reasonable and timely objection. The Contractor shall not change the superintendent without the Owner's consent, which shall not unreasonably be withheld or delayed.

§ 3.10 Contractor's Construction and Submittal Schedules

§ 3.10.1 The Contractor, promptly after being awarded the Contract, shall submit for the Owner's and Architect's information a Contractor's construction schedule for the Work. The schedule shall contain detail appropriate for the Project, including (1) the date of commencement of the Work, interim schedule milestone dates, and the date of Substantial Completion; (2) an apportionment of the Work by construction activity; and (3) the time required for completion of each portion of the Work. The schedule shall provide for the orderly progression of the Work to completion and shall not exceed time limits current under the Contract Documents. The schedule shall be revised at appropriate intervals as required by the conditions of the Work and Project.

§ 3.10.2 The Contractor, promptly after being awarded the Contract and thereafter as necessary to maintain a current submittal schedule, shall submit a submittal schedule for the Architect's approval. The Architect's approval shall not be unreasonably delayed or withheld. The submittal schedule shall (1) be coordinated with the Contractor's construction schedule, and (2) allow the Architect reasonable time to review submittals. If the Contractor fails to submit a submittal schedule, or fails to provide submittals in accordance with the approved submittal schedule, the Contractor shall not be entitled to any increase in Contract Sum or extension of Contract Time based on the time required for review of submittals.

§ 3.10.3 The Contractor shall perform the Work in general accordance with the most recent schedules submitted to the Owner and Architect.

§ 3.11 Documents and Samples at the Site

The Contractor shall make available, at the Project site, the Contract Documents, including Change Orders, Construction Change Directives, and other Modifications, in good order and marked currently to indicate field changes and selections made during construction, and the approved Shop Drawings, Product Data, Samples, and similar required submittals. These shall be in electronic form or paper copy, available to the Architect and Owner, and

Init.

AIA Document A201® – 2017. Copyright © 1911, 1915, 1918, 1925, 1937, 1951, 1958, 1961, 1963, 1966, 1970, 1976, 1987, 1997, 2007 and 2017 by The American Institute of Architects. All rights reserved. The "American Institute of Architects," "AIA," the AIA Logo, "A201," and "AIA Contract Documents" are registered trademarks and may not be used without permission. This document was produced by AIA software at 10:53:20 ET on 06/30/2022 under Order No.2054927631 which expires on 08/20/2022, is not for resale, is licensed for one-time use only, and may only be used in accordance with the AIA Contract Documents® Terms of Service. To report copyright violations, e-mail copyright@aia.org.

User Notes:

(1652185154)

delivered to the Architect for submittal to the Owner upon completion of the Work as a record of the Work as constructed.

§ 3.12 Shop Drawings, Product Data and Samples

§ 3.12.1 Shop Drawings are drawings, diagrams, schedules, and other data specially prepared for the Work by the Contractor or a Subcontractor, Sub-subcontractor, manufacturer, supplier, or distributor to illustrate some portion of the Work.

§ 3.12.2 Product Data are illustrations, standard schedules, performance charts, instructions, brochures, diagrams, and other information furnished by the Contractor to illustrate materials or equipment for some portion of the Work.

§ 3.12.3 Samples are physical examples that illustrate materials, equipment, or workmanship, and establish standards by which the Work will be judged.

§ 3.12.4 Shop Drawings, Product Data, Samples, and similar submittals are not Contract Documents. Their purpose is to demonstrate how the Contractor proposes to conform to the information given and the design concept expressed in the Contract Documents for those portions of the Work for which the Contract Documents require submittals. Review by the Architect is subject to the limitations of Section 4.2.7. Informational submittals upon which the Architect is not expected to take responsive action may be so identified in the Contract Documents. Submittals that are not required by the Contract Documents may be returned by the Architect without action.

§ 3.12.5 The Contractor shall review for compliance with the Contract Documents, approve, and submit to the Architect, Shop Drawings, Product Data, Samples, and similar submittals required by the Contract Documents, in accordance with the submittal schedule approved by the Architect or, in the absence of an approved submittal schedule, with reasonable promptness and in such sequence as to cause no delay in the Work or in the activities of the Owner or of Separate Contractors.

§ 3.12.6 By submitting Shop Drawings, Product Data, Samples, and similar submittals, the Contractor represents to the Owner and Architect that the Contractor has (1) reviewed and approved them, (2) determined and verified materials, field measurements and field construction criteria related thereto, or will do so, and (3) checked and coordinated the information contained within such submittals with the requirements of the Work and of the Contract Documents.

§ 3.12.7 The Contractor shall perform no portion of the Work for which the Contract Documents require submittal and review of Shop Drawings, Product Data, Samples, or similar submittals, until the respective submittal has been approved by the Architect.

§ 3.12.8 The Work shall be in accordance with approved submittals except that the Contractor shall not be relieved of responsibility for deviations from the requirements of the Contract Documents by the Architect's approval of Shop Drawings, Product Data, Samples, or similar submittals, unless the Contractor has specifically notified the Architect of such deviation at the time of submittal and (1) the Architect has given written approval to the specific deviation as a minor change in the Work, or (2) a Change Order or Construction Change Directive has been issued authorizing the deviation. The Contractor shall not be relieved of responsibility for errors or omissions in Shop Drawings, Product Data, Samples, or similar submittals, by the Architect's approval thereof.

§ 3.12.9 The Contractor shall direct specific attention, in writing or on resubmitted Shop Drawings, Product Data, Samples, or similar submittals, to revisions other than those requested by the Architect on previous submittals. In the absence of such notice, the Architect's approval of a resubmission shall not apply to such revisions.

§ 3.12.10 The Contractor shall not be required to provide professional services that constitute the practice of architecture or engineering unless such services are specifically required by the Contract Documents for a portion of the Work or unless the Contractor needs to provide such services in order to carry out the Contractor's responsibilities for construction means, methods, techniques, sequences, and procedures. The Contractor shall not be required to provide professional services in violation of applicable law.

§ 3.12.10.1 If professional design services or certifications by a design professional related to systems, materials, or equipment are specifically required of the Contractor by the Contract Documents, the Owner and the Architect will

Init.

specify all performance and design criteria that such services must satisfy. The Contractor shall be entitled to rely upon the adequacy and accuracy of the performance and design criteria provided in the Contract Documents. The Contractor shall cause such services or certifications to be provided by an appropriately licensed design professional, whose signature and seal shall appear on all drawings, calculations, specifications, certifications, Shop Drawings, and other submittals prepared by such professional. Shop Drawings, and other submittals related to the Work, designed or certified by such professional, if prepared by others, shall bear such professional's written approval when submitted to the Architect. The Owner and the Architect shall be entitled to rely upon the adequacy and accuracy of the services, certifications, and approvals performed or provided by such design professionals, provided the Owner and Architect have specified to the Contractor the performance and design criteria that such services must satisfy. Pursuant to this Section 3.12.10, the Architect will review and approve or take other appropriate action on submittals only for the limited purpose of checking for conformance with information given and the design concept expressed in the Contract Documents.

§ 3.12.10.2 If the Contract Documents require the Contractor's design professional to certify that the Work has been performed in accordance with the design criteria, the Contractor shall furnish such certifications to the Architect at the time and in the form specified by the Architect.

§ 3.13 Use of Site

The Contractor shall confine operations at the site to areas permitted by applicable laws, statutes, ordinances, codes, rules and regulations, lawful orders of public authorities, and the Contract Documents and shall not unreasonably encumber the site with materials or equipment.

§ 3.14 Cutting and Patching

§ 3.14.1 The Contractor shall be responsible for cutting, fitting, or patching required to complete the Work or to make its parts fit together properly. All areas requiring cutting, fitting, or patching shall be restored to the condition existing prior to the cutting, fitting, or patching, unless otherwise required by the Contract Documents.

§ 3.14.2 The Contractor shall not damage or endanger a portion of the Work or fully or partially completed construction of the Owner or Separate Contractors by cutting, patching, or otherwise altering such construction, or by excavation. The Contractor shall not cut or otherwise alter construction by the Owner or a Separate Contractor except with written consent of the Owner and of the Separate Contractor. Consent shall not be unreasonably withheld. The Contractor shall not unreasonably withhold, from the Owner or a Separate Contractor, its consent to cutting or otherwise altering the Work.

§ 3.15 Cleaning Up

§ 3.15.1 The Contractor shall keep the premises and surrounding area free from accumulation of waste materials and rubbish caused by operations under the Contract. At completion of the Work, the Contractor shall remove waste materials, rubbish, the Contractor's tools, construction equipment, machinery, and surplus materials from and about the Project.

§ 3.15.2 If the Contractor fails to clean up as provided in the Contract Documents, the Owner may do so and the Owner shall be entitled to reimbursement from the Contractor.

§ 3.16 Access to Work

The Contractor shall provide the Owner and Architect with access to the Work in preparation and progress wherever located.

§ 3.17 Royalties, Patents and Copyrights

The Contractor shall pay all royalties and license fees. The Contractor shall defend suits or claims for infringement of copyrights and patent rights and shall hold the Owner and Architect harmless from loss on account thereof, but shall not be responsible for defense or loss when a particular design, process, or product of a particular manufacturer or manufacturers is required by the Contract Documents, or where the copyright violations are contained in Drawings, Specifications, or other documents prepared by the Owner or Architect. However, if an infringement of a copyright or patent is discovered by, or made known to, the Contractor, the Contractor shall be responsible for the loss unless the information is promptly furnished to the Architect.

§ 3.18 Indemnification

§ 3.18.1 To the fullest extent permitted by law, the Contractor shall indemnify and hold harmless the Owner, Architect, Architect's consultants, and agents and employees of any of them from and against claims, damages, losses, and expenses, including but not limited to attorneys' fees, arising out of or resulting from performance of the Work, provided that such claim, damage, loss, or expense is attributable to bodily injury, sickness, disease or death, or to injury to or destruction of tangible property (other than the Work itself), but only to the extent caused by the negligent acts or omissions of the Contractor, a Subcontractor, anyone directly or indirectly employed by them, or anyone for whose acts they may be liable, regardless of whether or not such claim, damage, loss, or expense is caused in part by a party indemnified hereunder. Such obligation shall not be construed to negate, abridge, or reduce other rights or obligations of indemnity that would otherwise exist as to a party or person described in this Section 3.18.

§ 3.18.2 In claims against any person or entity indemnified under this Section 3.18 by an employee of the Contractor, a Subcontractor, anyone directly or indirectly employed by them, or anyone for whose acts they may be liable, the indemnification obligation under Section 3.18.1 shall not be limited by a limitation on amount or type of damages, compensation, or benefits payable by or for the Contractor or a Subcontractor under workers' compensation acts, disability benefit acts, or other employee benefit acts.

ARTICLE 4 ARCHITECT

§ 4.1 General

§ 4.1.1 The Architect is the person or entity retained by the Owner pursuant to Section 2.3.2 and identified as such in the Agreement.

§ 4.1.2 Duties, responsibilities, and limitations of authority of the Architect as set forth in the Contract Documents shall not be restricted, modified, or extended without written consent of the Owner, Contractor, and Architect. Consent shall not be unreasonably withheld.

§ 4.2 Administration of the Contract

§ 4.2.1 The Architect will provide administration of the Contract as described in the Contract Documents and will be an Owner's representative during construction until the date the Architect issues the final Certificate for Payment. The Architect will have authority to act on behalf of the Owner only to the extent provided in the Contract Documents.

§ 4.2.2 The Architect will visit the site at intervals appropriate to the stage of construction, or as otherwise agreed with the Owner, to become generally familiar with the progress and quality of the portion of the Work completed, and to determine in general if the Work observed is being performed in a manner indicating that the Work, when fully completed, will be in accordance with the Contract Documents. However, the Architect will not be required to make exhaustive or continuous on-site inspections to check the quality or quantity of the Work. The Architect will not have control over, charge of, or responsibility for the construction means, methods, techniques, sequences or procedures, or for the safety precautions and programs in connection with the Work, since these are solely the Contractor's rights and responsibilities under the Contract Documents.

§ 4.2.3 On the basis of the site visits, the Architect will keep the Owner reasonably informed about the progress and quality of the portion of the Work completed, and promptly report to the Owner (1) known deviations from the Contract Documents, (2) known deviations from the most recent construction schedule submitted by the Contractor, and (3) defects and deficiencies observed in the Work. The Architect will not be responsible for the Contractor's failure to perform the Work in accordance with the requirements of the Contract Documents. The Architect will not have control over or charge of, and will not be responsible for acts or omissions of, the Contractor, Subcontractors, or their agents or employees, or any other persons or entities performing portions of the Work.

§ 4.2.4 Communications

The Owner and Contractor shall include the Architect in all communications that relate to or affect the Architect's services or professional responsibilities. The Owner shall promptly notify the Architect of the substance of any direct communications between the Owner and the Contractor otherwise relating to the Project. Communications by and with the Architect's consultants shall be through the Architect. Communications by and with Subcontractors and suppliers shall be through the Contractor. Communications by and with Separate Contractors shall be through the Owner. The Contract Documents may specify other communication protocols.

§ 4.2.5 Based on the Architect's evaluations of the Contractor's Applications for Payment, the Architect will review and certify the amounts due the Contractor and will issue Certificates for Payment in such amounts.

§ 4.2.6 The Architect has authority to reject Work that does not conform to the Contract Documents. Whenever the Architect considers it necessary or advisable, the Architect will have authority to require inspection or testing of the Work in accordance with Sections 13.4.2 and 13.4.3, whether or not the Work is fabricated, installed or completed. However, neither this authority of the Architect nor a decision made in good faith either to exercise or not to exercise such authority shall give rise to a duty or responsibility of the Architect to the Contractor, Subcontractors, suppliers, their agents or employees, or other persons or entities performing portions of the Work.

§ 4.2.7 The Architect will review and approve, or take other appropriate action upon, the Contractor's submittals such as Shop Drawings, Product Data, and Samples, but only for the limited purpose of checking for conformance with information given and the design concept expressed in the Contract Documents. The Architect's action will be taken in accordance with the submittal schedule approved by the Architect or, in the absence of an approved submittal schedule, with reasonable promptness while allowing sufficient time in the Architect's professional judgment to permit adequate review. Review of such submittals is not conducted for the purpose of determining the accuracy and completeness of other details such as dimensions and quantities, or for substantiating instructions for installation or performance of equipment or systems, all of which remain the responsibility of the Contractor as required by the Contract Documents. The Architect's review of the Contractor's submittals shall not relieve the Contractor of the obligations under Sections 3.3, 3.5, and 3.12. The Architect's review shall not constitute approval of safety precautions or of any construction means, methods, techniques, sequences, or procedures. The Architect's approval of a specific item shall not indicate approval of an assembly of which the item is a component.

§ 4.2.8 The Architect will prepare Change Orders and Construction Change Directives, and may order minor changes in the Work as provided in Section 7.4. The Architect will investigate and make determinations and recommendations regarding concealed and unknown conditions as provided in Section 3.7.4.

§ 4.2.9 The Architect will conduct inspections to determine the date or dates of Substantial Completion and the date of final completion; issue Certificates of Substantial Completion pursuant to Section 9.8; receive and forward to the Owner, for the Owner's review and records, written warranties and related documents required by the Contract and assembled by the Contractor pursuant to Section 9.10; and issue a final Certificate for Payment pursuant to Section 9.10.

§ 4.2.10 If the Owner and Architect agree, the Architect will provide one or more Project representatives to assist in carrying out the Architect's responsibilities at the site. The Owner shall notify the Contractor of any change in the duties, responsibilities and limitations of authority of the Project representatives.

§ 4.2.11 The Architect will interpret and decide matters concerning performance under, and requirements of, the Contract Documents on written request of either the Owner or Contractor. The Architect's response to such requests will be made in writing within any time limits agreed upon or otherwise with reasonable promptness.

§ 4.2.12 Interpretations and decisions of the Architect will be consistent with the intent of, and reasonably inferable from, the Contract Documents and will be in writing or in the form of drawings. When making such interpretations and decisions, the Architect will endeavor to secure faithful performance by both Owner and Contractor, will not show partiality to either, and will not be liable for results of interpretations or decisions rendered in good faith.

§ 4.2.13 The Architect's decisions on matters relating to aesthetic effect will be final if consistent with the intent expressed in the Contract Documents.

§ 4.2.14 The Architect will review and respond to requests for information about the Contract Documents. The Architect's response to such requests will be made in writing within any time limits agreed upon or otherwise with reasonable promptness. If appropriate, the Architect will prepare and issue supplemental Drawings and Specifications in response to the requests for information.

Init.

ARTICLE 5 SUBCONTRACTORS

§ 5.1 Definitions

§ 5.1.1 A Subcontractor is a person or entity who has a direct contract with the Contractor to perform a portion of the Work at the site. The term "Subcontractor" is referred to throughout the Contract Documents as if singular in number and means a Subcontractor or an authorized representative of the Subcontractor. The term "Subcontractor" does not include a Separate Contractor or the subcontractors of a Separate Contractor.

§ 5.1.2 A Sub-subcontractor is a person or entity who has a direct or indirect contract with a Subcontractor to perform a portion of the Work at the site. The term "Sub-subcontractor" is referred to throughout the Contract Documents as if singular in number and means a Sub-subcontractor or an authorized representative of the Sub-subcontractor.

§ 5.2 Award of Subcontracts and Other Contracts for Portions of the Work

§ 5.2.1 Unless otherwise stated in the Contract Documents, the Contractor, as soon as practicable after award of the Contract, shall notify the Owner and Architect of the persons or entities proposed for each principal portion of the Work, including those who are to furnish materials or equipment fabricated to a special design. Within 14 days of receipt of the information, the Architect may notify the Contractor whether the Owner or the Architect (1) has reasonable objection to any such proposed person or entity or (2) requires additional time for review. Failure of the Architect to provide notice within the 14-day period shall constitute notice of no reasonable objection.

§ 5.2.2 The Contractor shall not contract with a proposed person or entity to whom the Owner or Architect has made reasonable and timely objection. The Contractor shall not be required to contract with anyone to whom the Contractor has made reasonable objection.

§ 5.2.3 If the Owner or Architect has reasonable objection to a person or entity proposed by the Contractor, the Contractor shall propose another to whom the Owner or Architect has no reasonable objection. If the proposed but rejected Subcontractor was reasonably capable of performing the Work, the Contract Sum and Contract Time shall be increased or decreased by the difference, if any, occasioned by such change, and an appropriate Change Order shall be issued before commencement of the substitute Subcontractor's Work. However, no increase in the Contract Sum or Contract Time shall be allowed for such change unless the Contractor has acted promptly and responsively in submitting names as required.

§ 5.2.4 The Contractor shall not substitute a Subcontractor, person, or entity for one previously selected if the Owner or Architect makes reasonable objection to such substitution.

§ 5.3 Subcontractual Relations

By appropriate written agreement, the Contractor shall require each Subcontractor, to the extent of the Work to be performed by the Subcontractor, to be bound to the Contractor by terms of the Contract Documents, and to assume toward the Contractor all the obligations and responsibilities, including the responsibility for safety of the Subcontractor's Work that the Contractor, by these Contract Documents, assumes toward the Owner and Architect. Each subcontract agreement shall preserve and protect the rights of the Owner and Architect under the Contract Documents with respect to the Work to be performed by the Subcontractor so that subcontracting thereof will not prejudice such rights, and shall allow to the Subcontractor, unless specifically provided otherwise in the subcontract agreement, the benefit of all rights, remedies, and redress against the Contractor that the Contractor, by the Contract Documents, has against the Owner. Where appropriate, the Contractor shall require each Subcontractor to enter into similar agreements with Sub-subcontractors. The Contractor shall make available to each proposed Subcontractor, prior to the execution of the subcontract agreement, copies of the Contract Documents to which the Subcontractor will be bound, and, upon written request of the Subcontractor, identify to the Subcontractor terms and conditions of the proposed subcontract agreement that may be at variance with the Contract Documents. Subcontractors will similarly make copies of applicable portions of such documents available to their respective proposed Sub-subcontractors.

§ 5.4 Contingent Assignment of Subcontracts

§ 5.4.1 Each subcontract agreement for a portion of the Work is assigned by the Contractor to the Owner, provided that

- .1 assignment is effective only after termination of the Contract by the Owner for cause pursuant to Section 14.2 and only for those subcontract agreements that the Owner accepts by notifying the Subcontractor and Contractor; and
- .2 assignment is subject to the prior rights of the surety, if any, obligated under bond relating to the Contract.

Init.

AIA Document A201® – 2017. Copyright © 1911, 1915, 1918, 1925, 1937, 1951, 1958, 1961, 1963, 1966, 1970, 1976, 1987, 1997, 2007 and 2017 by The American Institute of Architects. All rights reserved. The "American Institute of Architects," "AIA," the AIA Logo, "A201," and "AIA Contract Documents" are registered trademarks and may not be used without permission. This document was produced by AIA software at 10:53:20 ET on 06/30/2022 under Order No.2054927631 which expires on 08/20/2022, is not for resale, is licensed for one-time use only, and may only be used in accordance with the AIA Contract Documents® Terms of Service. To report copyright violations, e-mail copyright@aia.org.

User Notes:

(1652185154)

When the Owner accepts the assignment of a subcontract agreement, the Owner assumes the Contractor's rights and obligations under the subcontract.

§ 5.4.2 Upon such assignment, if the Work has been suspended for more than 30 days, the Subcontractor's compensation shall be equitably adjusted for increases in cost resulting from the suspension.

§ 5.4.3 Upon assignment to the Owner under this Section 5.4, the Owner may further assign the subcontract to a successor contractor or other entity. If the Owner assigns the subcontract to a successor contractor or other entity, the Owner shall nevertheless remain legally responsible for all of the successor contractor's obligations under the subcontract.

ARTICLE 6 CONSTRUCTION BY OWNER OR BY SEPARATE CONTRACTORS

§ 6.1 Owner's Right to Perform Construction and to Award Separate Contracts

§ 6.1.1 The term "Separate Contractor(s)" shall mean other contractors retained by the Owner under separate agreements. The Owner reserves the right to perform construction or operations related to the Project with the Owner's own forces, and with Separate Contractors retained under Conditions of the Contract substantially similar to those of this Contract, including those provisions of the Conditions of the Contract related to insurance and waiver of subrogation.

§ 6.1.2 When separate contracts are awarded for different portions of the Project or other construction or operations on the site, the term "Contractor" in the Contract Documents in each case shall mean the Contractor who executes each separate Owner-Contractor Agreement.

§ 6.1.3 The Owner shall provide for coordination of the activities of the Owner's own forces and of each Separate Contractor with the Work of the Contractor, who shall cooperate with them. The Contractor shall participate with any Separate Contractors and the Owner in reviewing their construction schedules. The Contractor shall make any revisions to its construction schedule deemed necessary after a joint review and mutual agreement. The construction schedules shall then constitute the schedules to be used by the Contractor, Separate Contractors, and the Owner until subsequently revised.

§ 6.1.4 Unless otherwise provided in the Contract Documents, when the Owner performs construction or operations related to the Project with the Owner's own forces or with Separate Contractors, the Owner or its Separate Contractors shall have the same obligations and rights that the Contractor has under the Conditions of the Contract, including, without excluding others, those stated in Article 3, this Article 6, and Articles 10, 11, and 12.

§ 6.2 Mutual Responsibility

§ 6.2.1 The Contractor shall afford the Owner and Separate Contractors reasonable opportunity for introduction and storage of their materials and equipment and performance of their activities, and shall connect and coordinate the Contractor's construction and operations with theirs as required by the Contract Documents.

§ 6.2.2 If part of the Contractor's Work depends for proper execution or results upon construction or operations by the Owner or a Separate Contractor, the Contractor shall, prior to proceeding with that portion of the Work, promptly notify the Architect of apparent discrepancies or defects in the construction or operations by the Owner or Separate Contractor that would render it unsuitable for proper execution and results of the Contractor's Work. Failure of the Contractor to notify the Architect of apparent discrepancies or defects prior to proceeding with the Work shall constitute an acknowledgment that the Owner's or Separate Contractor's completed or partially completed construction is fit and proper to receive the Contractor's Work. The Contractor shall not be responsible for discrepancies or defects in the construction or operations by the Owner or Separate Contractor that are not apparent.

§ 6.2.3 The Contractor shall reimburse the Owner for costs the Owner incurs that are payable to a Separate Contractor because of the Contractor's delays, improperly timed activities or defective construction. The Owner shall be responsible to the Contractor for costs the Contractor incurs because of a Separate Contractor's delays, improperly timed activities, damage to the Work or defective construction.

§ 6.2.4 The Contractor shall promptly remedy damage that the Contractor wrongfully causes to completed or partially completed construction or to property of the Owner or Separate Contractor as provided in Section 10.2.5.

Init.

§ 6.2.5 The Owner and each Separate Contractor shall have the same responsibilities for cutting and patching as are described for the Contractor in Section 3.14.

§ 6.3 Owner's Right to Clean Up

If a dispute arises among the Contractor, Separate Contractors, and the Owner as to the responsibility under their respective contracts for maintaining the premises and surrounding area free from waste materials and rubbish, the Owner may clean up and the Architect will allocate the cost among those responsible.

ARTICLE 7 CHANGES IN THE WORK

§ 7.1 General

§ 7.1.1 Changes in the Work may be accomplished after execution of the Contract, and without invalidating the Contract, by Change Order, Construction Change Directive or order for a minor change in the Work, subject to the limitations stated in this Article 7 and elsewhere in the Contract Documents.

§ 7.1.2 A Change Order shall be based upon agreement among the Owner, Contractor, and Architect. A Construction Change Directive requires agreement by the Owner and Architect and may or may not be agreed to by the Contractor. An order for a minor change in the Work may be issued by the Architect alone.

§ 7.1.3 Changes in the Work shall be performed under applicable provisions of the Contract Documents. The Contractor shall proceed promptly with changes in the Work, unless otherwise provided in the Change Order, Construction Change Directive, or order for a minor change in the Work.

§ 7.2 Change Orders

§ 7.2.1 A Change Order is a written instrument prepared by the Architect and signed by the Owner, Contractor, and Architect stating their agreement upon all of the following:

- .1 The change in the Work;
- .2 The amount of the adjustment, if any, in the Contract Sum; and
- .3 The extent of the adjustment, if any, in the Contract Time.

§ 7.3 Construction Change Directives

§ 7.3.1 A Construction Change Directive is a written order prepared by the Architect and signed by the Owner and Architect, directing a change in the Work prior to agreement on adjustment, if any, in the Contract Sum or Contract Time, or both. The Owner may by Construction Change Directive, without invalidating the Contract, order changes in the Work within the general scope of the Contract consisting of additions, deletions, or other revisions, the Contract Sum and Contract Time being adjusted accordingly.

§ 7.3.2 A Construction Change Directive shall be used in the absence of total agreement on the terms of a Change Order.

§ 7.3.3 If the Construction Change Directive provides for an adjustment to the Contract Sum, the adjustment shall be based on one of the following methods:

- .1 Mutual acceptance of a lump sum properly itemized and supported by sufficient substantiating data to permit evaluation;
- .2 Unit prices stated in the Contract Documents or subsequently agreed upon;
- .3 Cost to be determined in a manner agreed upon by the parties and a mutually acceptable fixed or percentage fee; or
- .4 As provided in Section 7.3.4.

§ 7.3.4 If the Contractor does not respond promptly or disagrees with the method for adjustment in the Contract Sum, the Architect shall determine the adjustment on the basis of reasonable expenditures and savings of those performing the Work attributable to the change, including, in case of an increase in the Contract Sum, an amount for overhead and profit as set forth in the Agreement, or if no such amount is set forth in the Agreement, a reasonable amount. In such case, and also under Section 7.3.3.3, the Contractor shall keep and present, in such form as the Architect may prescribe, an itemized accounting together with appropriate supporting data. Unless otherwise provided in the Contract Documents, costs for the purposes of this Section 7.3.4 shall be limited to the following:

Init.

- .1 Costs of labor, including applicable payroll taxes, fringe benefits required by agreement or custom, workers' compensation insurance, and other employee costs approved by the Architect;
- .2 Costs of materials, supplies, and equipment, including cost of transportation, whether incorporated or consumed;
- .3 Rental costs of machinery and equipment, exclusive of hand tools, whether rented from the Contractor or others;
- .4 Costs of premiums for all bonds and insurance, permit fees, and sales, use, or similar taxes, directly related to the change; and
- .5 Costs of supervision and field office personnel directly attributable to the change.

§ 7.3.5 If the Contractor disagrees with the adjustment in the Contract Time, the Contractor may make a Claim in accordance with applicable provisions of Article 15.

§ 7.3.6 Upon receipt of a Construction Change Directive, the Contractor shall promptly proceed with the change in the Work involved and advise the Architect of the Contractor's agreement or disagreement with the method, if any, provided in the Construction Change Directive for determining the proposed adjustment in the Contract Sum or Contract Time.

§ 7.3.7 A Construction Change Directive signed by the Contractor indicates the Contractor's agreement therewith, including adjustment in Contract Sum and Contract Time or the method for determining them. Such agreement shall be effective immediately and shall be recorded as a Change Order.

§ 7.3.8 The amount of credit to be allowed by the Contractor to the Owner for a deletion or change that results in a net decrease in the Contract Sum shall be actual net cost as confirmed by the Architect. When both additions and credits covering related Work or substitutions are involved in a change, the allowance for overhead and profit shall be figured on the basis of net increase, if any, with respect to that change.

§ 7.3.9 Pending final determination of the total cost of a Construction Change Directive to the Owner, the Contractor may request payment for Work completed under the Construction Change Directive in Applications for Payment. The Architect will make an interim determination for purposes of monthly certification for payment for those costs and certify for payment the amount that the Architect determines, in the Architect's professional judgment, to be reasonably justified. The Architect's interim determination of cost shall adjust the Contract Sum on the same basis as a Change Order, subject to the right of either party to disagree and assert a Claim in accordance with Article 15.

§ 7.3.10 When the Owner and Contractor agree with a determination made by the Architect concerning the adjustments in the Contract Sum and Contract Time, or otherwise reach agreement upon the adjustments, such agreement shall be effective immediately and the Architect will prepare a Change Order. Change Orders may be issued for all or any part of a Construction Change Directive.

§ 7.4 Minor Changes in the Work

The Architect may order minor changes in the Work that are consistent with the intent of the Contract Documents and do not involve an adjustment in the Contract Sum or an extension of the Contract Time. The Architect's order for minor changes shall be in writing. If the Contractor believes that the proposed minor change in the Work will affect the Contract Sum or Contract Time, the Contractor shall notify the Architect and shall not proceed to implement the change in the Work. If the Contractor performs the Work set forth in the Architect's order for a minor change without prior notice to the Architect that such change will affect the Contract Sum or Contract Time, the Contractor waives any adjustment to the Contract Sum or extension of the Contract Time.

ARTICLE 8 TIME

§ 8.1 Definitions

§ 8.1.1 Unless otherwise provided, Contract Time is the period of time, including authorized adjustments, allotted in the Contract Documents for Substantial Completion of the Work.

§ 8.1.2 The date of commencement of the Work is the date established in the Agreement.

§ 8.1.3 The date of Substantial Completion is the date certified by the Architect in accordance with Section 9.8.

Init.

§ 8.1.4 The term "day" as used in the Contract Documents shall mean calendar day unless otherwise specifically defined.

§ 8.2 Progress and Completion

§ 8.2.1 Time limits stated in the Contract Documents are of the essence of the Contract. By executing the Agreement, the Contractor confirms that the Contract Time is a reasonable period for performing the Work.

§ 8.2.2 The Contractor shall not knowingly, except by agreement or instruction of the Owner in writing, commence the Work prior to the effective date of insurance required to be furnished by the Contractor and Owner.

§ 8.2.3 The Contractor shall proceed expeditiously with adequate forces and shall achieve Substantial Completion within the Contract Time.

§ 8.3 Delays and Extensions of Time

§ 8.3.1 If the Contractor is delayed at any time in the commencement or progress of the Work by (1) an act or neglect of the Owner or Architect, of an employee of either, or of a Separate Contractor; (2) by changes ordered in the Work; (3) by labor disputes, fire, unusual delay in deliveries, unavoidable casualties, adverse weather conditions documented in accordance with Section 15.1.6.2, or other causes beyond the Contractor's control; (4) by delay authorized by the Owner pending mediation and binding dispute resolution; or (5) by other causes that the Contractor asserts, and the Architect determines, justify delay, then the Contract Time shall be extended for such reasonable time as the Architect may determine.

§ 8.3.2 Claims relating to time shall be made in accordance with applicable provisions of Article 15.

§ 8.3.3 This Section 8.3 does not preclude recovery of damages for delay by either party under other provisions of the Contract Documents.

ARTICLE 9 PAYMENTS AND COMPLETION

§ 9.1 Contract Sum

§ 9.1.1 The Contract Sum is stated in the Agreement and, including authorized adjustments, is the total amount payable by the Owner to the Contractor for performance of the Work under the Contract Documents.

§ 9.1.2 If unit prices are stated in the Contract Documents or subsequently agreed upon, and if quantities originally contemplated are materially changed so that application of such unit prices to the actual quantities causes substantial inequity to the Owner or Contractor, the applicable unit prices shall be equitably adjusted.

§ 9.2 Schedule of Values

Where the Contract is based on a stipulated sum or Guaranteed Maximum Price, the Contractor shall submit a schedule of values to the Architect before the first Application for Payment, allocating the entire Contract Sum to the various portions of the Work. The schedule of values shall be prepared in the form, and supported by the data to substantiate its accuracy, required by the Architect. This schedule, unless objected to by the Architect, shall be used as a basis for reviewing the Contractor's Applications for Payment. Any changes to the schedule of values shall be submitted to the Architect and supported by such data to substantiate its accuracy as the Architect may require, and unless objected to by the Architect, shall be used as a basis for reviewing the Contractor's subsequent Applications for Payment.

§ 9.3 Applications for Payment

§ 9.3.1 At least ten days before the date established for each progress payment, the Contractor shall submit to the Architect an itemized Application for Payment prepared in accordance with the schedule of values, if required under Section 9.2, for completed portions of the Work. The application shall be notarized, if required, and supported by all data substantiating the Contractor's right to payment that the Owner or Architect require, such as copies of requisitions, and releases and waivers of liens from Subcontractors and suppliers, and shall reflect retainage if provided for in the Contract Documents.

§ 9.3.1.1 As provided in Section 7.3.9, such applications may include requests for payment on account of changes in the Work that have been properly authorized by Construction Change Directives, or by interim determinations of the Architect, but not yet included in Change Orders.

Init.

§ 9.3.1.2 Applications for Payment shall not include requests for payment for portions of the Work for which the Contractor does not intend to pay a Subcontractor or supplier, unless such Work has been performed by others whom the Contractor intends to pay.

§ 9.3.2 Unless otherwise provided in the Contract Documents, payments shall be made on account of materials and equipment delivered and suitably stored at the site for subsequent incorporation in the Work. If approved in advance by the Owner, payment may similarly be made for materials and equipment suitably stored off the site at a location agreed upon in writing. Payment for materials and equipment stored on or off the site shall be conditioned upon compliance by the Contractor with procedures satisfactory to the Owner to establish the Owner's title to such materials and equipment or otherwise protect the Owner's interest, and shall include the costs of applicable insurance, storage, and transportation to the site, for such materials and equipment stored off the site.

§ 9.3.3 The Contractor warrants that title to all Work covered by an Application for Payment will pass to the Owner no later than the time of payment. The Contractor further warrants that upon submittal of an Application for Payment all Work for which Certificates for Payment have been previously issued and payments received from the Owner shall, to the best of the Contractor's knowledge, information, and belief, be free and clear of liens, claims, security interests, or encumbrances, in favor of the Contractor, Subcontractors, suppliers, or other persons or entities that provided labor, materials, and equipment relating to the Work.

§ 9.4 Certificates for Payment

§ 9.4.1 The Architect will, within seven days after receipt of the Contractor's Application for Payment, either (1) issue to the Owner a Certificate for Payment in the full amount of the Application for Payment, with a copy to the Contractor; or (2) issue to the Owner a Certificate for Payment for such amount as the Architect determines is properly due, and notify the Contractor and Owner of the Architect's reasons for withholding certification in part as provided in Section 9.5.1; or (3) withhold certification of the entire Application for Payment, and notify the Contractor and Owner of the Architect's reason for withholding certification in whole as provided in Section 9.5.1.

§ 9.4.2 The issuance of a Certificate for Payment will constitute a representation by the Architect to the Owner, based on the Architect's evaluation of the Work and the data in the Application for Payment, that, to the best of the Architect's knowledge, information, and belief, the Work has progressed to the point indicated, the quality of the Work is in accordance with the Contract Documents, and that the Contractor is entitled to payment in the amount certified. The foregoing representations are subject to an evaluation of the Work for conformance with the Contract Documents upon Substantial Completion, to results of subsequent tests and inspections, to correction of minor deviations from the Contract Documents prior to completion, and to specific qualifications expressed by the Architect. However, the issuance of a Certificate for Payment will not be a representation that the Architect has (1) made exhaustive or continuous on-site inspections to check the quality or quantity of the Work; (2) reviewed construction means, methods, techniques, sequences, or procedures; (3) reviewed copies of requisitions received from Subcontractors and suppliers and other data requested by the Owner to substantiate the Contractor's right to payment; or (4) made examination to ascertain how or for what purpose the Contractor has used money previously paid on account of the Contract Sum.

§ 9.5 Decisions to Withhold Certification

§ 9.5.1 The Architect may withhold a Certificate for Payment in whole or in part, to the extent reasonably necessary to protect the Owner, if in the Architect's opinion the representations to the Owner required by Section 9.4.2 cannot be made. If the Architect is unable to certify payment in the amount of the Application, the Architect will notify the Contractor and Owner as provided in Section 9.4.1. If the Contractor and Architect cannot agree on a revised amount, the Architect will promptly issue a Certificate for Payment for the amount for which the Architect is able to make such representations to the Owner. The Architect may also withhold a Certificate for Payment or, because of subsequently discovered evidence, may nullify the whole or a part of a Certificate for Payment previously issued, to such extent as may be necessary in the Architect's opinion to protect the Owner from loss for which the Contractor is responsible, including loss resulting from acts and omissions described in Section 3.3.2, because of

- .1 defective Work not remedied;
- .2 third party claims filed or reasonable evidence indicating probable filing of such claims, unless security acceptable to the Owner is provided by the Contractor;
- .3 failure of the Contractor to make payments properly to Subcontractors or suppliers for labor, materials or equipment;

Init.

- .4 reasonable evidence that the Work cannot be completed for the unpaid balance of the Contract Sum;
- .5 damage to the Owner or a Separate Contractor;
- .6 reasonable evidence that the Work will not be completed within the Contract Time, and that the unpaid balance would not be adequate to cover actual or liquidated damages for the anticipated delay; or
- .7 repeated failure to carry out the Work in accordance with the Contract Documents.

§ 9.5.2 When either party disputes the Architect's decision regarding a Certificate for Payment under Section 9.5.1, in whole or in part, that party may submit a Claim in accordance with Article 15.

§ 9.5.3 When the reasons for withholding certification are removed, certification will be made for amounts previously withheld.

§ 9.5.4 If the Architect withholds certification for payment under Section 9.5.1.3, the Owner may, at its sole option, issue joint checks to the Contractor and to any Subcontractor or supplier to whom the Contractor failed to make payment for Work properly performed or material or equipment suitably delivered. If the Owner makes payments by joint check, the Owner shall notify the Architect and the Contractor shall reflect such payment on its next Application for Payment.

§ 9.6 Progress Payments

§ 9.6.1 After the Architect has issued a Certificate for Payment, the Owner shall make payment in the manner and within the time provided in the Contract Documents, and shall so notify the Architect.

§ 9.6.2 The Contractor shall pay each Subcontractor, no later than seven days after receipt of payment from the Owner, the amount to which the Subcontractor is entitled, reflecting percentages actually retained from payments to the Contractor on account of the Subcontractor's portion of the Work. The Contractor shall, by appropriate agreement with each Subcontractor, require each Subcontractor to make payments to Sub-subcontractors in a similar manner.

§ 9.6.3 The Architect will, on request, furnish to a Subcontractor, if practicable, information regarding percentages of completion or amounts applied for by the Contractor and action taken thereon by the Architect and Owner on account of portions of the Work done by such Subcontractor.

§ 9.6.4 The Owner has the right to request written evidence from the Contractor that the Contractor has properly paid Subcontractors and suppliers amounts paid by the Owner to the Contractor for subcontracted Work. If the Contractor fails to furnish such evidence within seven days, the Owner shall have the right to contact Subcontractors and suppliers to ascertain whether they have been properly paid. Neither the Owner nor Architect shall have an obligation to pay, or to see to the payment of money to, a Subcontractor or supplier, except as may otherwise be required by law.

§ 9.6.5 The Contractor's payments to suppliers shall be treated in a manner similar to that provided in Sections 9.6.2, 9.6.3 and 9.6.4.

§ 9.6.6 A Certificate for Payment, a progress payment, or partial or entire use or occupancy of the Project by the Owner shall not constitute acceptance of Work not in accordance with the Contract Documents.

§ 9.6.7 Unless the Contractor provides the Owner with a payment bond in the full penal sum of the Contract Sum, payments received by the Contractor for Work properly performed by Subcontractors or provided by suppliers shall be held by the Contractor for those Subcontractors or suppliers who performed Work or furnished materials, or both, under contract with the Contractor for which payment was made by the Owner. Nothing contained herein shall require money to be placed in a separate account and not commingled with money of the Contractor, create any fiduciary liability or tort liability on the part of the Contractor for breach of trust, or entitle any person or entity to an award of punitive damages against the Contractor for breach of the requirements of this provision.

§ 9.6.8 Provided the Owner has fulfilled its payment obligations under the Contract Documents, the Contractor shall defend and indemnify the Owner from all loss, liability, damage or expense, including reasonable attorney's fees and litigation expenses, arising out of any lien claim or other claim for payment by any Subcontractor or supplier of any tier. Upon receipt of notice of a lien claim or other claim for payment, the Owner shall notify the Contractor. If approved by the applicable court, when required, the Contractor may substitute a surety bond for the property against which the lien or other claim for payment has been asserted.

§ 9.7 Failure of Payment

If the Architect does not issue a Certificate for Payment, through no fault of the Contractor, within seven days after receipt of the Contractor's Application for Payment, or if the Owner does not pay the Contractor within seven days after the date established in the Contract Documents, the amount certified by the Architect or awarded by binding dispute resolution, then the Contractor may, upon seven additional days' notice to the Owner and Architect, stop the Work until payment of the amount owing has been received. The Contract Time shall be extended appropriately and the Contract Sum shall be increased by the amount of the Contractor's reasonable costs of shutdown, delay and start-up, plus interest as provided for in the Contract Documents.

§ 9.8 Substantial Completion

§ 9.8.1 Substantial Completion is the stage in the progress of the Work when the Work or designated portion thereof is sufficiently complete in accordance with the Contract Documents so that the Owner can occupy or utilize the Work for its intended use.

§ 9.8.2 When the Contractor considers that the Work, or a portion thereof which the Owner agrees to accept separately, is substantially complete, the Contractor shall prepare and submit to the Architect a comprehensive list of items to be completed or corrected prior to final payment. Failure to include an item on such list does not alter the responsibility of the Contractor to complete all Work in accordance with the Contract Documents.

§ 9.8.3 Upon receipt of the Contractor's list, the Architect will make an inspection to determine whether the Work or designated portion thereof is substantially complete. If the Architect's inspection discloses any item, whether or not included on the Contractor's list, which is not sufficiently complete in accordance with the Contract Documents so that the Owner can occupy or utilize the Work or designated portion thereof for its intended use, the Contractor shall, before issuance of the Certificate of Substantial Completion, complete or correct such item upon notification by the Architect. In such case, the Contractor shall then submit a request for another inspection by the Architect to determine Substantial Completion.

§ 9.8.4 When the Work or designated portion thereof is substantially complete, the Architect will prepare a Certificate of Substantial Completion that shall establish the date of Substantial Completion; establish responsibilities of the Owner and Contractor for security, maintenance, heat, utilities, damage to the Work and insurance; and fix the time within which the Contractor shall finish all items on the list accompanying the Certificate. Warranties required by the Contract Documents shall commence on the date of Substantial Completion of the Work or designated portion thereof unless otherwise provided in the Certificate of Substantial Completion.

§ 9.8.5 The Certificate of Substantial Completion shall be submitted to the Owner and Contractor for their written acceptance of responsibilities assigned to them in the Certificate. Upon such acceptance, and consent of surety if any, the Owner shall make payment of retainage applying to the Work or designated portion thereof. Such payment shall be adjusted for Work that is incomplete or not in accordance with the requirements of the Contract Documents.

§ 9.9 Partial Occupancy or Use

§ 9.9.1 The Owner may occupy or use any completed or partially completed portion of the Work at any stage when such portion is designated by separate agreement with the Contractor, provided such occupancy or use is consented to by the insurer and authorized by public authorities having jurisdiction over the Project. Such partial occupancy or use may commence whether or not the portion is substantially complete, provided the Owner and Contractor have accepted in writing the responsibilities assigned to each of them for payments, retainage, if any, security, maintenance, heat, utilities, damage to the Work and insurance, and have agreed in writing concerning the period for correction of the Work and commencement of warranties required by the Contract Documents. When the Contractor considers a portion substantially complete, the Contractor shall prepare and submit a list to the Architect as provided under Section 9.8.2. Consent of the Contractor to partial occupancy or use shall not be unreasonably withheld. The stage of the progress of the Work shall be determined by written agreement between the Owner and Contractor or, if no agreement is reached, by decision of the Architect.

§ 9.9.2 Immediately prior to such partial occupancy or use, the Owner, Contractor, and Architect shall jointly inspect the area to be occupied or portion of the Work to be used in order to determine and record the condition of the Work.

§ 9.9.3 Unless otherwise agreed upon, partial occupancy or use of a portion or portions of the Work shall not constitute acceptance of Work not complying with the requirements of the Contract Documents.

§ 9.10 Final Completion and Final Payment

§ 9.10.1 Upon receipt of the Contractor's notice that the Work is ready for final inspection and acceptance and upon receipt of a final Application for Payment, the Architect will promptly make such inspection. When the Architect finds the Work acceptable under the Contract Documents and the Contract fully performed, the Architect will promptly issue a final Certificate for Payment stating that to the best of the Architect's knowledge, information and belief, and on the basis of the Architect's on-site visits and inspections, the Work has been completed in accordance with the Contract Documents and that the entire balance found to be due the Contractor and noted in the final Certificate is due and payable. The Architect's final Certificate for Payment will constitute a further representation that conditions listed in Section 9.10.2 as precedent to the Contractor's being entitled to final payment have been fulfilled.

§ 9.10.2 Neither final payment nor any remaining retained percentage shall become due until the Contractor submits to the Architect (1) an affidavit that payrolls, bills for materials and equipment, and other indebtedness connected with the Work for which the Owner or the Owner's property might be responsible or encumbered (less amounts withheld by Owner) have been paid or otherwise satisfied, (2) a certificate evidencing that insurance required by the Contract Documents to remain in force after final payment is currently in effect, (3) a written statement that the Contractor knows of no reason that the insurance will not be renewable to cover the period required by the Contract Documents, (4) consent of surety, if any, to final payment, (5) documentation of any special warranties, such as manufacturers' warranties or specific Subcontractor warranties, and (6) if required by the Owner, other data establishing payment or satisfaction of obligations, such as receipts and releases and waivers of liens, claims, security interests, or encumbrances arising out of the Contract, to the extent and in such form as may be designated by the Owner. If a Subcontractor refuses to furnish a release or waiver required by the Owner, the Contractor may furnish a bond satisfactory to the Owner to indemnify the Owner against such lien, claim, security interest, or encumbrance. If a lien, claim, security interest, or encumbrance remains unsatisfied after payments are made, the Contractor shall refund to the Owner all money that the Owner may be compelled to pay in discharging the lien, claim, security interest, or encumbrance, including all costs and reasonable attorneys' fees.

§ 9.10.3 If, after Substantial Completion of the Work, final completion thereof is materially delayed through no fault of the Contractor or by issuance of Change Orders affecting final completion, and the Architect so confirms, the Owner shall, upon application by the Contractor and certification by the Architect, and without terminating the Contract, make payment of the balance due for that portion of the Work fully completed, corrected, and accepted. If the remaining balance for Work not fully completed or corrected is less than retainage stipulated in the Contract Documents, and if bonds have been furnished, the written consent of the surety to payment of the balance due for that portion of the Work fully completed and accepted shall be submitted by the Contractor to the Architect prior to certification of such payment. Such payment shall be made under terms and conditions governing final payment, except that it shall not constitute a waiver of Claims.

§ 9.10.4 The making of final payment shall constitute a waiver of Claims by the Owner except those arising from

- .1 liens, Claims, security interests, or encumbrances arising out of the Contract and unsettled;
- .2 failure of the Work to comply with the requirements of the Contract Documents;
- .3 terms of special warranties required by the Contract Documents; or
- .4 audits performed by the Owner, if permitted by the Contract Documents, after final payment.

§ 9.10.5 Acceptance of final payment by the Contractor, a Subcontractor, or a supplier, shall constitute a waiver of claims by that payee except those previously made in writing and identified by that payee as unsettled at the time of final Application for Payment.

ARTICLE 10 PROTECTION OF PERSONS AND PROPERTY

§ 10.1 Safety Precautions and Programs

The Contractor shall be responsible for initiating, maintaining, and supervising all safety precautions and programs in connection with the performance of the Contract.

§ 10.2 Safety of Persons and Property

§ 10.2.1 The Contractor shall take reasonable precautions for safety of, and shall provide reasonable protection to prevent damage, injury, or loss to

Init.

AIA Document A201® – 2017. Copyright © 1911, 1915, 1918, 1925, 1937, 1951, 1958, 1961, 1963, 1966, 1970, 1976, 1987, 1997, 2007 and 2017 by The American Institute of Architects. All rights reserved. The "American Institute of Architects," "AIA," the AIA Logo, "A201," and "AIA Contract Documents" are registered trademarks and may not be used without permission. This document was produced by AIA software at 10:53:20 ET on 06/30/2022 under Order No.2054927631 which expires on 08/20/2022, is not for resale, is licensed for one-time use only, and may only be used in accordance with the AIA Contract Documents® Terms of Service. To report copyright violations, e-mail copyright@aia.org.

User Notes:

(1652185154)

- .1 employees on the Work and other persons who may be affected thereby;
- .2 the Work and materials and equipment to be incorporated therein, whether in storage on or off the site, under care, custody, or control of the Contractor, a Subcontractor, or a Sub-subcontractor; and
- .3 other property at the site or adjacent thereto, such as trees, shrubs, lawns, walks, pavements, roadways, structures, and utilities not designated for removal, relocation, or replacement in the course of construction.

§ 10.2.2 The Contractor shall comply with, and give notices required by applicable laws, statutes, ordinances, codes, rules and regulations, and lawful orders of public authorities, bearing on safety of persons or property or their protection from damage, injury, or loss.

§ 10.2.3 The Contractor shall implement, erect, and maintain, as required by existing conditions and performance of the Contract, reasonable safeguards for safety and protection, including posting danger signs and other warnings against hazards; promulgating safety regulations; and notifying the owners and users of adjacent sites and utilities of the safeguards.

§ 10.2.4 When use or storage of explosives or other hazardous materials or equipment, or unusual methods are necessary for execution of the Work, the Contractor shall exercise utmost care and carry on such activities under supervision of properly qualified personnel.

§ 10.2.5 The Contractor shall promptly remedy damage and loss (other than damage or loss insured under property insurance required by the Contract Documents) to property referred to in Sections 10.2.1.2 and 10.2.1.3 caused in whole or in part by the Contractor, a Subcontractor, a Sub-subcontractor, or anyone directly or indirectly employed by any of them, or by anyone for whose acts they may be liable and for which the Contractor is responsible under Sections 10.2.1.2 and 10.2.1.3. The Contractor may make a Claim for the cost to remedy the damage or loss to the extent such damage or loss is attributable to acts or omissions of the Owner or Architect or anyone directly or indirectly employed by either of them, or by anyone for whose acts either of them may be liable, and not attributable to the fault or negligence of the Contractor. The foregoing obligations of the Contractor are in addition to the Contractor's obligations under Section 3.18.

§ 10.2.6 The Contractor shall designate a responsible member of the Contractor's organization at the site whose duty shall be the prevention of accidents. This person shall be the Contractor's superintendent unless otherwise designated by the Contractor in writing to the Owner and Architect.

§ 10.2.7 The Contractor shall not permit any part of the construction or site to be loaded so as to cause damage or create an unsafe condition.

§ 10.2.8 Injury or Damage to Person or Property

If either party suffers injury or damage to person or property because of an act or omission of the other party, or of others for whose acts such party is legally responsible, notice of the injury or damage, whether or not insured, shall be given to the other party within a reasonable time not exceeding 21 days after discovery. The notice shall provide sufficient detail to enable the other party to investigate the matter.

§ 10.3 Hazardous Materials and Substances

§ 10.3.1 The Contractor is responsible for compliance with any requirements included in the Contract Documents regarding hazardous materials or substances. If the Contractor encounters a hazardous material or substance not addressed in the Contract Documents and if reasonable precautions will be inadequate to prevent foreseeable bodily injury or death to persons resulting from a material or substance, including but not limited to asbestos or polychlorinated biphenyl (PCB), encountered on the site by the Contractor, the Contractor shall, upon recognizing the condition, immediately stop Work in the affected area and notify the Owner and Architect of the condition.

§ 10.3.2 Upon receipt of the Contractor's notice, the Owner shall obtain the services of a licensed laboratory to verify the presence or absence of the material or substance reported by the Contractor and, in the event such material or substance is found to be present, to cause it to be rendered harmless. Unless otherwise required by the Contract Documents, the Owner shall furnish in writing to the Contractor and Architect the names and qualifications of persons or entities who are to perform tests verifying the presence or absence of the material or substance or who are to perform the task of removal or safe containment of the material or substance. The Contractor and the Architect will

Init.

promptly reply to the Owner in writing stating whether or not either has reasonable objection to the persons or entities proposed by the Owner. If either the Contractor or Architect has an objection to a person or entity proposed by the Owner, the Owner shall propose another to whom the Contractor and the Architect have no reasonable objection. When the material or substance has been rendered harmless, Work in the affected area shall resume upon written agreement of the Owner and Contractor. By Change Order, the Contract Time shall be extended appropriately and the Contract Sum shall be increased by the amount of the Contractor's reasonable additional costs of shutdown, delay, and start-up.

§ 10.3.3 To the fullest extent permitted by law, the Owner shall indemnify and hold harmless the Contractor, Subcontractors, Architect, Architect's consultants, and agents and employees of any of them from and against claims, damages, losses, and expenses, including but not limited to attorneys' fees, arising out of or resulting from performance of the Work in the affected area if in fact the material or substance presents the risk of bodily injury or death as described in Section 10.3.1 and has not been rendered harmless, provided that such claim, damage, loss, or expense is attributable to bodily injury, sickness, disease or death, or to injury to or destruction of tangible property (other than the Work itself), except to the extent that such damage, loss, or expense is due to the fault or negligence of the party seeking indemnity.

§ 10.3.4 The Owner shall not be responsible under this Section 10.3 for hazardous materials or substances the Contractor brings to the site unless such materials or substances are required by the Contract Documents. The Owner shall be responsible for hazardous materials or substances required by the Contract Documents, except to the extent of the Contractor's fault or negligence in the use and handling of such materials or substances.

§ 10.3.5 The Contractor shall reimburse the Owner for the cost and expense the Owner incurs (1) for remediation of hazardous materials or substances the Contractor brings to the site and negligently handles, or (2) where the Contractor fails to perform its obligations under Section 10.3.1, except to the extent that the cost and expense are due to the Owner's fault or negligence.

§ 10.3.6 If, without negligence on the part of the Contractor, the Contractor is held liable by a government agency for the cost of remediation of a hazardous material or substance solely by reason of performing Work as required by the Contract Documents, the Owner shall reimburse the Contractor for all cost and expense thereby incurred.

§ 10.4 Emergencies

In an emergency affecting safety of persons or property, the Contractor shall act, at the Contractor's discretion, to prevent threatened damage, injury, or loss. Additional compensation or extension of time claimed by the Contractor on account of an emergency shall be determined as provided in Article 15 and Article 7.

ARTICLE 11 INSURANCE AND BONDS

§ 11.1 Contractor's Insurance and Bonds

§ 11.1.1 The Contractor shall purchase and maintain insurance of the types and limits of liability, containing the endorsements, and subject to the terms and conditions, as described in the Agreement or elsewhere in the Contract Documents. The Contractor shall purchase and maintain the required insurance from an insurance company or insurance companies lawfully authorized to issue insurance in the jurisdiction where the Project is located. The Owner, Architect, and Architect's consultants shall be named as additional insureds under the Contractor's commercial general liability policy or as otherwise described in the Contract Documents.

§ 11.1.2 The Contractor shall provide surety bonds of the types, for such penal sums, and subject to such terms and conditions as required by the Contract Documents. The Contractor shall purchase and maintain the required bonds from a company or companies lawfully authorized to issue surety bonds in the jurisdiction where the Project is located.

§ 11.1.3 Upon the request of any person or entity appearing to be a potential beneficiary of bonds covering payment of obligations arising under the Contract, the Contractor shall promptly furnish a copy of the bonds or shall authorize a copy to be furnished.

§ 11.1.4 **Notice of Cancellation or Expiration of Contractor's Required Insurance.** Within three (3) business days of the date the Contractor becomes aware of an impending or actual cancellation or expiration of any insurance required by the Contract Documents, the Contractor shall provide notice to the Owner of such impending or actual cancellation or expiration. Upon receipt of notice from the Contractor, the Owner shall, unless the lapse in coverage arises from an act

Init.

or omission of the Owner, have the right to stop the Work until the lapse in coverage has been cured by the procurement of replacement coverage by the Contractor. The furnishing of notice by the Contractor shall not relieve the Contractor of any contractual obligation to provide any required coverage.

§ 11.2 Owner's Insurance

§ 11.2.1 The Owner shall purchase and maintain insurance of the types and limits of liability, containing the endorsements, and subject to the terms and conditions, as described in the Agreement or elsewhere in the Contract Documents. The Owner shall purchase and maintain the required insurance from an insurance company or insurance companies lawfully authorized to issue insurance in the jurisdiction where the Project is located.

§ 11.2.2 Failure to Purchase Required Property Insurance. If the Owner fails to purchase and maintain the required property insurance, with all of the coverages and in the amounts described in the Agreement or elsewhere in the Contract Documents, the Owner shall inform the Contractor in writing prior to commencement of the Work. Upon receipt of notice from the Owner, the Contractor may delay commencement of the Work and may obtain insurance that will protect the interests of the Contractor, Subcontractors, and Sub-Subcontractors in the Work. When the failure to provide coverage has been cured or resolved, the Contract Sum and Contract Time shall be equitably adjusted. In the event the Owner fails to procure coverage, the Owner waives all rights against the Contractor, Subcontractors, and Sub-subcontractors to the extent the loss to the Owner would have been covered by the insurance to have been procured by the Owner. The cost of the insurance shall be charged to the Owner by a Change Order. If the Owner does not provide written notice, and the Contractor is damaged by the failure or neglect of the Owner to purchase or maintain the required insurance, the Owner shall reimburse the Contractor for all reasonable costs and damages attributable thereto.

§ 11.2.3 Notice of Cancellation or Expiration of Owner's Required Property Insurance. Within three (3) business days of the date the Owner becomes aware of an impending or actual cancellation or expiration of any property insurance required by the Contract Documents, the Owner shall provide notice to the Contractor of such impending or actual cancellation or expiration. Unless the lapse in coverage arises from an act or omission of the Contractor: (1) the Contractor, upon receipt of notice from the Owner, shall have the right to stop the Work until the lapse in coverage has been cured by the procurement of replacement coverage by either the Owner or the Contractor; (2) the Contract Time and Contract Sum shall be equitably adjusted; and (3) the Owner waives all rights against the Contractor, Subcontractors, and Sub-subcontractors to the extent any loss to the Owner would have been covered by the insurance had it not expired or been cancelled. If the Contractor purchases replacement coverage, the cost of the insurance shall be charged to the Owner by an appropriate Change Order. The furnishing of notice by the Owner shall not relieve the Owner of any contractual obligation to provide required insurance.

§ 11.3 Waivers of Subrogation

§ 11.3.1 The Owner and Contractor waive all rights against (1) each other and any of their subcontractors, sub-subcontractors, agents, and employees, each of the other; (2) the Architect and Architect's consultants; and (3) Separate Contractors, if any, and any of their subcontractors, sub-subcontractors, agents, and employees, for damages caused by fire, or other causes of loss, to the extent those losses are covered by property insurance required by the Agreement or other property insurance applicable to the Project, except such rights as they have to proceeds of such insurance. The Owner or Contractor, as appropriate, shall require similar written waivers in favor of the individuals and entities identified above from the Architect, Architect's consultants, Separate Contractors, subcontractors, and sub-subcontractors. The policies of insurance purchased and maintained by each person or entity agreeing to waive claims pursuant to this section 11.3.1 shall not prohibit this waiver of subrogation. This waiver of subrogation shall be effective as to a person or entity (1) even though that person or entity would otherwise have a duty of indemnification, contractual or otherwise, (2) even though that person or entity did not pay the insurance premium directly or indirectly, or (3) whether or not the person or entity had an insurable interest in the damaged property.

§ 11.3.2 If during the Project construction period the Owner insures properties, real or personal or both, at or adjacent to the site by property insurance under policies separate from those insuring the Project, or if after final payment property insurance is to be provided on the completed Project through a policy or policies other than those insuring the Project during the construction period, to the extent permissible by such policies, the Owner waives all rights in accordance with the terms of Section 11.3.1 for damages caused by fire or other causes of loss covered by this separate property insurance.

§ 11.4 Loss of Use, Business Interruption, and Delay in Completion Insurance

Init.

AIA Document A201® – 2017. Copyright © 1911, 1915, 1918, 1925, 1937, 1951, 1958, 1961, 1963, 1966, 1970, 1976, 1987, 1997, 2007 and 2017 by The American Institute of Architects. All rights reserved. The "American Institute of Architects," "AIA," the AIA Logo, "A201," and "AIA Contract Documents" are registered trademarks and may not be used without permission. This document was produced by AIA software at 10:53:20 ET on 06/30/2022 under Order No.2054927631 which expires on 08/20/2022, is not for resale, is licensed for one-time use only, and may only be used in accordance with the AIA Contract Documents® Terms of Service. To report copyright violations, e-mail copyright@aia.org.

User Notes:

(1652185154)

The Owner, at the Owner's option, may purchase and maintain insurance that will protect the Owner against loss of use of the Owner's property, or the inability to conduct normal operations, due to fire or other causes of loss. The Owner waives all rights of action against the Contractor and Architect for loss of use of the Owner's property, due to fire or other hazards however caused.

§11.5 Adjustment and Settlement of Insured Loss

§ 11.5.1 A loss insured under the property insurance required by the Agreement shall be adjusted by the Owner as fiduciary and made payable to the Owner as fiduciary for the insureds, as their interests may appear, subject to requirements of any applicable mortgagee clause and of Section 11.5.2. The Owner shall pay the Architect and Contractor their just shares of insurance proceeds received by the Owner, and by appropriate agreements the Architect and Contractor shall make payments to their consultants and Subcontractors in similar manner.

§ 11.5.2 Prior to settlement of an insured loss, the Owner shall notify the Contractor of the terms of the proposed settlement as well as the proposed allocation of the insurance proceeds. The Contractor shall have 14 days from receipt of notice to object to the proposed settlement or allocation of the proceeds. If the Contractor does not object, the Owner shall settle the loss and the Contractor shall be bound by the settlement and allocation. Upon receipt, the Owner shall deposit the insurance proceeds in a separate account and make the appropriate distributions. Thereafter, if no other agreement is made or the Owner does not terminate the Contract for convenience, the Owner and Contractor shall execute a Change Order for reconstruction of the damaged or destroyed Work in the amount allocated for that purpose. If the Contractor timely objects to either the terms of the proposed settlement or the allocation of the proceeds, the Owner may proceed to settle the insured loss, and any dispute between the Owner and Contractor arising out of the settlement or allocation of the proceeds shall be resolved pursuant to Article 15. Pending resolution of any dispute, the Owner may issue a Construction Change Directive for the reconstruction of the damaged or destroyed Work.

ARTICLE 12 UNCOVERING AND CORRECTION OF WORK

§ 12.1 Uncovering of Work

§ 12.1.1 If a portion of the Work is covered contrary to the Architect's request or to requirements specifically expressed in the Contract Documents, it must, if requested in writing by the Architect, be uncovered for the Architect's examination and be replaced at the Contractor's expense without change in the Contract Time.

§ 12.1.2 If a portion of the Work has been covered that the Architect has not specifically requested to examine prior to its being covered, the Architect may request to see such Work and it shall be uncovered by the Contractor. If such Work is in accordance with the Contract Documents, the Contractor shall be entitled to an equitable adjustment to the Contract Sum and Contract Time as may be appropriate. If such Work is not in accordance with the Contract Documents, the costs of uncovering the Work, and the cost of correction, shall be at the Contractor's expense.

§ 12.2 Correction of Work

§ 12.2.1 Before Substantial Completion

The Contractor shall promptly correct Work rejected by the Architect or failing to conform to the requirements of the Contract Documents, discovered before Substantial Completion and whether or not fabricated, installed or completed. Costs of correcting such rejected Work, including additional testing and inspections, the cost of uncovering and replacement, and compensation for the Architect's services and expenses made necessary thereby, shall be at the Contractor's expense.

§ 12.2.2 After Substantial Completion

§ 12.2.2.1 In addition to the Contractor's obligations under Section 3.5, if, within one year after the date of Substantial Completion of the Work or designated portion thereof or after the date for commencement of warranties established under Section 9.9.1, or by terms of any applicable special warranty required by the Contract Documents, any of the Work is found to be not in accordance with the requirements of the Contract Documents, the Contractor shall correct it promptly after receipt of notice from the Owner to do so, unless the Owner has previously given the Contractor a written acceptance of such condition. The Owner shall give such notice promptly after discovery of the condition. During the one-year period for correction of Work, if the Owner fails to notify the Contractor and give the Contractor an opportunity to make the correction, the Owner waives the rights to require correction by the Contractor and to make a claim for breach of warranty. If the Contractor fails to correct nonconforming Work within a reasonable time during that period after receipt of notice from the Owner or Architect, the Owner may correct it in accordance with Section 2.5.

§ 12.2.2.2 The one-year period for correction of Work shall be extended with respect to portions of Work first performed after Substantial Completion by the period of time between Substantial Completion and the actual completion of that portion of the Work.

§ 12.2.2.3 The one-year period for correction of Work shall not be extended by corrective Work performed by the Contractor pursuant to this Section 12.2.

§ 12.2.3 The Contractor shall remove from the site portions of the Work that are not in accordance with the requirements of the Contract Documents and are neither corrected by the Contractor nor accepted by the Owner.

§ 12.2.4 The Contractor shall bear the cost of correcting destroyed or damaged construction of the Owner or Separate Contractors, whether completed or partially completed, caused by the Contractor's correction or removal of Work that is not in accordance with the requirements of the Contract Documents.

§ 12.2.5 Nothing contained in this Section 12.2 shall be construed to establish a period of limitation with respect to other obligations the Contractor has under the Contract Documents. Establishment of the one-year period for correction of Work as described in Section 12.2.2 relates only to the specific obligation of the Contractor to correct the Work, and has no relationship to the time within which the obligation to comply with the Contract Documents may be sought to be enforced, nor to the time within which proceedings may be commenced to establish the Contractor's liability with respect to the Contractor's obligations other than specifically to correct the Work.

§ 12.3 Acceptance of Nonconforming Work

If the Owner prefers to accept Work that is not in accordance with the requirements of the Contract Documents, the Owner may do so instead of requiring its removal and correction, in which case the Contract Sum will be reduced as appropriate and equitable. Such adjustment shall be effected whether or not final payment has been made.

ARTICLE 13 MISCELLANEOUS PROVISIONS

§ 13.1 Governing Law

The Contract shall be governed by the law of the place where the Project is located, excluding that jurisdiction's choice of law rules. If the parties have selected arbitration as the method of binding dispute resolution, the Federal Arbitration Act shall govern Section 15.4.

§ 13.2 Successors and Assigns

§ 13.2.1 The Owner and Contractor respectively bind themselves, their partners, successors, assigns, and legal representatives to covenants, agreements, and obligations contained in the Contract Documents. Except as provided in Section 13.2.2, neither party to the Contract shall assign the Contract as a whole without written consent of the other. If either party attempts to make an assignment without such consent, that party shall nevertheless remain legally responsible for all obligations under the Contract.

§ 13.2.2 The Owner may, without consent of the Contractor, assign the Contract to a lender providing construction financing for the Project, if the lender assumes the Owner's rights and obligations under the Contract Documents. The Contractor shall execute all consents reasonably required to facilitate the assignment.

§ 13.3 Rights and Remedies

§ 13.3.1 Duties and obligations imposed by the Contract Documents and rights and remedies available thereunder shall be in addition to and not a limitation of duties, obligations, rights, and remedies otherwise imposed or available by law.

§ 13.3.2 No action or failure to act by the Owner, Architect, or Contractor shall constitute a waiver of a right or duty afforded them under the Contract, nor shall such action or failure to act constitute approval of or acquiescence in a breach thereunder, except as may be specifically agreed upon in writing.

§ 13.4 Tests and Inspections

§ 13.4.1 Tests, inspections, and approvals of portions of the Work shall be made as required by the Contract Documents and by applicable laws, statutes, ordinances, codes, rules, and regulations or lawful orders of public authorities. Unless otherwise provided, the Contractor shall make arrangements for such tests, inspections, and

approvals with an independent testing laboratory or entity acceptable to the Owner, or with the appropriate public authority, and shall bear all related costs of tests, inspections, and approvals. The Contractor shall give the Architect timely notice of when and where tests and inspections are to be made so that the Architect may be present for such procedures. The Owner shall bear costs of tests, inspections, or approvals that do not become requirements until after bids are received or negotiations concluded. The Owner shall directly arrange and pay for tests, inspections, or approvals where building codes or applicable laws or regulations so require.

§ 13.4.2 If the Architect, Owner, or public authorities having jurisdiction determine that portions of the Work require additional testing, inspection, or approval not included under Section 13.4.1, the Architect will, upon written authorization from the Owner, instruct the Contractor to make arrangements for such additional testing, inspection, or approval, by an entity acceptable to the Owner, and the Contractor shall give timely notice to the Architect of when and where tests and inspections are to be made so that the Architect may be present for such procedures. Such costs, except as provided in Section 13.4.3, shall be at the Owner's expense.

§ 13.4.3 If procedures for testing, inspection, or approval under Sections 13.4.1 and 13.4.2 reveal failure of the portions of the Work to comply with requirements established by the Contract Documents, all costs made necessary by such failure, including those of repeated procedures and compensation for the Architect's services and expenses, shall be at the Contractor's expense.

§ 13.4.4 Required certificates of testing, inspection, or approval shall, unless otherwise required by the Contract Documents, be secured by the Contractor and promptly delivered to the Architect.

§ 13.4.5 If the Architect is to observe tests, inspections, or approvals required by the Contract Documents, the Architect will do so promptly and, where practicable, at the normal place of testing.

§ 13.4.6 Tests or inspections conducted pursuant to the Contract Documents shall be made promptly to avoid unreasonable delay in the Work.

§ 13.5 Interest

Payments due and unpaid under the Contract Documents shall bear interest from the date payment is due at the rate the parties agree upon in writing or, in the absence thereof, at the legal rate prevailing from time to time at the place where the Project is located.

ARTICLE 14 TERMINATION OR SUSPENSION OF THE CONTRACT

§ 14.1 Termination by the Contractor

§ 14.1.1 The Contractor may terminate the Contract if the Work is stopped for a period of 30 consecutive days through no act or fault of the Contractor, a Subcontractor, a Sub-subcontractor, their agents or employees, or any other persons or entities performing portions of the Work, for any of the following reasons:

- .1 Issuance of an order of a court or other public authority having jurisdiction that requires all Work to be stopped;
- .2 An act of government, such as a declaration of national emergency, that requires all Work to be stopped;
- .3 Because the Architect has not issued a Certificate for Payment and has not notified the Contractor of the reason for withholding certification as provided in Section 9.4.1, or because the Owner has not made payment on a Certificate for Payment within the time stated in the Contract Documents; or
- .4 The Owner has failed to furnish to the Contractor reasonable evidence as required by Section 2.2.

§ 14.1.2 The Contractor may terminate the Contract if, through no act or fault of the Contractor, a Subcontractor, a Sub-subcontractor, their agents or employees, or any other persons or entities performing portions of the Work, repeated suspensions, delays, or interruptions of the entire Work by the Owner as described in Section 14.3, constitute in the aggregate more than 100 percent of the total number of days scheduled for completion, or 120 days in any 365-day period, whichever is less.

§ 14.1.3 If one of the reasons described in Section 14.1.1 or 14.1.2 exists, the Contractor may, upon seven days' notice to the Owner and Architect, terminate the Contract and recover from the Owner payment for Work executed, as well as reasonable overhead and profit on Work not executed, and costs incurred by reason of such termination.

§ 14.1.4 If the Work is stopped for a period of 60 consecutive days through no act or fault of the Contractor, a Subcontractor, a Sub-subcontractor, or their agents or employees or any other persons or entities performing portions of the Work because the Owner has repeatedly failed to fulfill the Owner's obligations under the Contract Documents with respect to matters important to the progress of the Work, the Contractor may, upon seven additional days' notice to the Owner and the Architect, terminate the Contract and recover from the Owner as provided in Section 14.1.3.

§ 14.2 Termination by the Owner for Cause

§ 14.2.1 The Owner may terminate the Contract if the Contractor

- .1 repeatedly refuses or fails to supply enough properly skilled workers or proper materials;
- .2 fails to make payment to Subcontractors or suppliers in accordance with the respective agreements between the Contractor and the Subcontractors or suppliers;
- .3 repeatedly disregards applicable laws, statutes, ordinances, codes, rules and regulations, or lawful orders of a public authority; or
- .4 otherwise is guilty of substantial breach of a provision of the Contract Documents.

§ 14.2.2 When any of the reasons described in Section 14.2.1 exist, and upon certification by the Architect that sufficient cause exists to justify such action, the Owner may, without prejudice to any other rights or remedies of the Owner and after giving the Contractor and the Contractor's surety, if any, seven days' notice, terminate employment of the Contractor and may, subject to any prior rights of the surety:

- .1 Exclude the Contractor from the site and take possession of all materials, equipment, tools, and construction equipment and machinery thereon owned by the Contractor;
- .2 Accept assignment of subcontracts pursuant to Section 5.4; and
- .3 Finish the Work by whatever reasonable method the Owner may deem expedient. Upon written request of the Contractor, the Owner shall furnish to the Contractor a detailed accounting of the costs incurred by the Owner in finishing the Work.

§ 14.2.3 When the Owner terminates the Contract for one of the reasons stated in Section 14.2.1, the Contractor shall not be entitled to receive further payment until the Work is finished.

§ 14.2.4 If the unpaid balance of the Contract Sum exceeds costs of finishing the Work, including compensation for the Architect's services and expenses made necessary thereby, and other damages incurred by the Owner and not expressly waived, such excess shall be paid to the Contractor. If such costs and damages exceed the unpaid balance, the Contractor shall pay the difference to the Owner. The amount to be paid to the Contractor or Owner, as the case may be, shall be certified by the Initial Decision Maker, upon application, and this obligation for payment shall survive termination of the Contract.

§ 14.3 Suspension by the Owner for Convenience

§ 14.3.1 The Owner may, without cause, order the Contractor in writing to suspend, delay or interrupt the Work, in whole or in part for such period of time as the Owner may determine.

§ 14.3.2 The Contract Sum and Contract Time shall be adjusted for increases in the cost and time caused by suspension, delay, or interruption under Section 14.3.1. Adjustment of the Contract Sum shall include profit. No adjustment shall be made to the extent

- .1 that performance is, was, or would have been, so suspended, delayed, or interrupted, by another cause for which the Contractor is responsible; or
- .2 that an equitable adjustment is made or denied under another provision of the Contract.

§ 14.4 Termination by the Owner for Convenience

§ 14.4.1 The Owner may, at any time, terminate the Contract for the Owner's convenience and without cause.

§ 14.4.2 Upon receipt of notice from the Owner of such termination for the Owner's convenience, the Contractor shall

- .1 cease operations as directed by the Owner in the notice;
- .2 take actions necessary, or that the Owner may direct, for the protection and preservation of the Work; and
- .3 except for Work directed to be performed prior to the effective date of termination stated in the notice, terminate all existing subcontracts and purchase orders and enter into no further subcontracts and purchase orders.

Init.

§ 14.4.3 In case of such termination for the Owner's convenience, the Owner shall pay the Contractor for Work properly executed; costs incurred by reason of the termination, including costs attributable to termination of Subcontracts; and the termination fee, if any, set forth in the Agreement.

ARTICLE 15 CLAIMS AND DISPUTES

§ 15.1 Claims

§ 15.1.1 Definition

A Claim is a demand or assertion by one of the parties seeking, as a matter of right, payment of money, a change in the Contract Time, or other relief with respect to the terms of the Contract. The term "Claim" also includes other disputes and matters in question between the Owner and Contractor arising out of or relating to the Contract. The responsibility to substantiate Claims shall rest with the party making the Claim. This Section 15.1.1 does not require the Owner to file a Claim in order to impose liquidated damages in accordance with the Contract Documents.

§ 15.1.2 Time Limits on Claims

The Owner and Contractor shall commence all Claims and causes of action against the other and arising out of or related to the Contract, whether in contract, tort, breach of warranty or otherwise, in accordance with the requirements of the binding dispute resolution method selected in the Agreement and within the period specified by applicable law, but in any case not more than 10 years after the date of Substantial Completion of the Work. The Owner and Contractor waive all Claims and causes of action not commenced in accordance with this Section 15.1.2.

§ 15.1.3 Notice of Claims

§ 15.1.3.1 Claims by either the Owner or Contractor, where the condition giving rise to the Claim is first discovered prior to expiration of the period for correction of the Work set forth in Section 12.2.2, shall be initiated by notice to the other party and to the Initial Decision Maker with a copy sent to the Architect, if the Architect is not serving as the Initial Decision Maker. Claims by either party under this Section 15.1.3.1 shall be initiated within 21 days after occurrence of the event giving rise to such Claim or within 21 days after the claimant first recognizes the condition giving rise to the Claim, whichever is later.

§ 15.1.3.2 Claims by either the Owner or Contractor, where the condition giving rise to the Claim is first discovered after expiration of the period for correction of the Work set forth in Section 12.2.2, shall be initiated by notice to the other party. In such event, no decision by the Initial Decision Maker is required.

§ 15.1.4 Continuing Contract Performance

§ 15.1.4.1 Pending final resolution of a Claim, except as otherwise agreed in writing or as provided in Section 9.7 and Article 14, the Contractor shall proceed diligently with performance of the Contract and the Owner shall continue to make payments in accordance with the Contract Documents.

§ 15.1.4.2 The Contract Sum and Contract Time shall be adjusted in accordance with the Initial Decision Maker's decision, subject to the right of either party to proceed in accordance with this Article 15. The Architect will issue Certificates for Payment in accordance with the decision of the Initial Decision Maker.

§ 15.1.5 Claims for Additional Cost

If the Contractor wishes to make a Claim for an increase in the Contract Sum, notice as provided in Section 15.1.3 shall be given before proceeding to execute the portion of the Work that is the subject of the Claim. Prior notice is not required for Claims relating to an emergency endangering life or property arising under Section 10.4.

§ 15.1.6 Claims for Additional Time

§ 15.1.6.1 If the Contractor wishes to make a Claim for an increase in the Contract Time, notice as provided in Section 15.1.3 shall be given. The Contractor's Claim shall include an estimate of cost and of probable effect of delay on progress of the Work. In the case of a continuing delay, only one Claim is necessary.

§ 15.1.6.2 If adverse weather conditions are the basis for a Claim for additional time, such Claim shall be documented by data substantiating that weather conditions were abnormal for the period of time, could not have been reasonably anticipated, and had an adverse effect on the scheduled construction.

Init.

§ 15.1.7 Waiver of Claims for Consequential Damages

The Contractor and Owner waive Claims against each other for consequential damages arising out of or relating to this Contract. This mutual waiver includes

- .1 damages incurred by the Owner for rental expenses, for losses of use, income, profit, financing, business and reputation, and for loss of management or employee productivity or of the services of such persons; and
- .2 damages incurred by the Contractor for principal office expenses including the compensation of personnel stationed there, for losses of financing, business and reputation, and for loss of profit, except anticipated profit arising directly from the Work.

This mutual waiver is applicable, without limitation, to all consequential damages due to either party's termination in accordance with Article 14. Nothing contained in this Section 15.1.7 shall be deemed to preclude assessment of liquidated damages, when applicable, in accordance with the requirements of the Contract Documents.

§ 15.2 Initial Decision

§ 15.2.1 Claims, excluding those where the condition giving rise to the Claim is first discovered after expiration of the period for correction of the Work set forth in Section 12.2.2 or arising under Sections 10.3, 10.4, and 11.5, shall be referred to the Initial Decision Maker for initial decision. The Architect will serve as the Initial Decision Maker, unless otherwise indicated in the Agreement. Except for those Claims excluded by this Section 15.2.1, an initial decision shall be required as a condition precedent to mediation of any Claim. If an initial decision has not been rendered within 30 days after the Claim has been referred to the Initial Decision Maker, the party asserting the Claim may demand mediation and binding dispute resolution without a decision having been rendered. Unless the Initial Decision Maker and all affected parties agree, the Initial Decision Maker will not decide disputes between the Contractor and persons or entities other than the Owner.

§ 15.2.2 The Initial Decision Maker will review Claims and within ten days of the receipt of a Claim take one or more of the following actions: (1) request additional supporting data from the claimant or a response with supporting data from the other party, (2) reject the Claim in whole or in part, (3) approve the Claim, (4) suggest a compromise, or (5) advise the parties that the Initial Decision Maker is unable to resolve the Claim if the Initial Decision Maker lacks sufficient information to evaluate the merits of the Claim or if the Initial Decision Maker concludes that, in the Initial Decision Maker's sole discretion, it would be inappropriate for the Initial Decision Maker to resolve the Claim.

§ 15.2.3 In evaluating Claims, the Initial Decision Maker may, but shall not be obligated to, consult with or seek information from either party or from persons with special knowledge or expertise who may assist the Initial Decision Maker in rendering a decision. The Initial Decision Maker may request the Owner to authorize retention of such persons at the Owner's expense.

§ 15.2.4 If the Initial Decision Maker requests a party to provide a response to a Claim or to furnish additional supporting data, such party shall respond, within ten days after receipt of the request, and shall either (1) provide a response on the requested supporting data, (2) advise the Initial Decision Maker when the response or supporting data will be furnished, or (3) advise the Initial Decision Maker that no supporting data will be furnished. Upon receipt of the response or supporting data, if any, the Initial Decision Maker will either reject or approve the Claim in whole or in part.

§ 15.2.5 The Initial Decision Maker will render an initial decision approving or rejecting the Claim, or indicating that the Initial Decision Maker is unable to resolve the Claim. This initial decision shall (1) be in writing; (2) state the reasons therefor; and (3) notify the parties and the Architect, if the Architect is not serving as the Initial Decision Maker, of any change in the Contract Sum or Contract Time or both. The initial decision shall be final and binding on the parties but subject to mediation and, if the parties fail to resolve their dispute through mediation, to binding dispute resolution.

§ 15.2.6 Either party may file for mediation of an initial decision at any time, subject to the terms of Section 15.2.6.1.

§ 15.2.6.1 Either party may, within 30 days from the date of receipt of an initial decision, demand in writing that the other party file for mediation. If such a demand is made and the party receiving the demand fails to file for mediation within 30 days after receipt thereof, then both parties waive their rights to mediate or pursue binding dispute resolution proceedings with respect to the initial decision.

Init.

AIA Document A201® – 2017. Copyright © 1911, 1915, 1918, 1925, 1937, 1951, 1958, 1961, 1963, 1966, 1970, 1976, 1987, 1997, 2007 and 2017 by The American Institute of Architects. All rights reserved. The "American Institute of Architects," "AIA," the AIA Logo, "A201," and "AIA Contract Documents" are registered trademarks and may not be used without permission. This document was produced by AIA software at 10:53:20 ET on 06/30/2022 under Order No.2054927631 which expires on 08/20/2022, is not for resale, is licensed for one-time use only, and may only be used in accordance with the AIA Contract Documents® Terms of Service. To report copyright violations, e-mail copyright@aia.org.

User Notes:

(1652185154)

§ 15.2.7 In the event of a Claim against the Contractor, the Owner may, but is not obligated to, notify the surety, if any, of the nature and amount of the Claim. If the Claim relates to a possibility of a Contractor's default, the Owner may, but is not obligated to, notify the surety and request the surety's assistance in resolving the controversy.

§ 15.2.8 If a Claim relates to or is the subject of a mechanic's lien, the party asserting such Claim may proceed in accordance with applicable law to comply with the lien notice or filing deadlines.

§ 15.3 Mediation

§ 15.3.1 Claims, disputes, or other matters in controversy arising out of or related to the Contract, except those waived as provided for in Sections 9.10.4, 9.10.5, and 15.1.7, shall be subject to mediation as a condition precedent to binding dispute resolution.

§ 15.3.2 The parties shall endeavor to resolve their Claims by mediation which, unless the parties mutually agree otherwise, shall be administered by the American Arbitration Association in accordance with its Construction Industry Mediation Procedures in effect on the date of the Agreement. A request for mediation shall be made in writing, delivered to the other party to the Contract, and filed with the person or entity administering the mediation. The request may be made concurrently with the filing of binding dispute resolution proceedings but, in such event, mediation shall proceed in advance of binding dispute resolution proceedings, which shall be stayed pending mediation for a period of 60 days from the date of filing, unless stayed for a longer period by agreement of the parties or court order. If an arbitration is stayed pursuant to this Section 15.3.2, the parties may nonetheless proceed to the selection of the arbitrator(s) and agree upon a schedule for later proceedings.

§ 15.3.3 Either party may, within 30 days from the date that mediation has been concluded without resolution of the dispute or 60 days after mediation has been demanded without resolution of the dispute, demand in writing that the other party file for binding dispute resolution. If such a demand is made and the party receiving the demand fails to file for binding dispute resolution within 60 days after receipt thereof, then both parties waive their rights to binding dispute resolution proceedings with respect to the initial decision.

§ 15.3.4 The parties shall share the mediator's fee and any filing fees equally. The mediation shall be held in the place where the Project is located, unless another location is mutually agreed upon. Agreements reached in mediation shall be enforceable as settlement agreements in any court having jurisdiction thereof.

§ 15.4 Arbitration

§ 15.4.1 If the parties have selected arbitration as the method for binding dispute resolution in the Agreement, any Claim subject to, but not resolved by, mediation shall be subject to arbitration which, unless the parties mutually agree otherwise, shall be administered by the American Arbitration Association in accordance with its Construction Industry Arbitration Rules in effect on the date of the Agreement. The Arbitration shall be conducted in the place where the Project is located, unless another location is mutually agreed upon. A demand for arbitration shall be made in writing, delivered to the other party to the Contract, and filed with the person or entity administering the arbitration. The party filing a notice of demand for arbitration must assert in the demand all Claims then known to that party on which arbitration is permitted to be demanded.

§ 15.4.1.1 A demand for arbitration shall be made no earlier than concurrently with the filing of a request for mediation, but in no event shall it be made after the date when the institution of legal or equitable proceedings based on the Claim would be barred by the applicable statute of limitations. For statute of limitations purposes, receipt of a written demand for arbitration by the person or entity administering the arbitration shall constitute the institution of legal or equitable proceedings based on the Claim.

§ 15.4.2 The award rendered by the arbitrator or arbitrators shall be final, and judgment may be entered upon it in accordance with applicable law in any court having jurisdiction thereof.

§ 15.4.3 The foregoing agreement to arbitrate and other agreements to arbitrate with an additional person or entity duly consented to by parties to the Agreement, shall be specifically enforceable under applicable law in any court having jurisdiction thereof.

§ 15.4.4 Consolidation or Joinder

§ 15.4.4.1 Subject to the rules of the American Arbitration Association or other applicable arbitration rules, either party may consolidate an arbitration conducted under this Agreement with any other arbitration to which it is a party provided that (1) the arbitration agreement governing the other arbitration permits consolidation, (2) the arbitrations to be consolidated substantially involve common questions of law or fact, and (3) the arbitrations employ materially similar procedural rules and methods for selecting arbitrator(s).

§ 15.4.4.2 Subject to the rules of the American Arbitration Association or other applicable arbitration rules, either party may include by joinder persons or entities substantially involved in a common question of law or fact whose presence is required if complete relief is to be accorded in arbitration, provided that the party sought to be joined consents in writing to such joinder. Consent to arbitration involving an additional person or entity shall not constitute consent to arbitration of any claim, dispute or other matter in question not described in the written consent.

§ 15.4.4.3 The Owner and Contractor grant to any person or entity made a party to an arbitration conducted under this Section 15.4, whether by joinder or consolidation, the same rights of joinder and consolidation as those of the Owner and Contractor under this Agreement.

Init.

State of West Virginia

Supplementary Conditions to AIA Document A201-2017
General Conditions of the Contract for Construction

The following Supplementary Conditions modify the General Conditions of the Contract for Construction, AIA Document A201, 2017 Edition. Where a portion of the General Conditions is modified or deleted by these Supplementary Conditions, the unaltered portions of the General Conditions shall remain in effect.

Order of Precedence: The documents contained in the contract to which this document has been attached shall be interpreted in the following order of precedence:

First Priority – Documents developed by the State or agency and utilized to provide public notice of the solicitation, along with other general terms and conditions shall be first in priority.

Second Priority – This document "Supplementary Conditions to the AIA Document A201-2017 General Conditions of the Contract for Construction" shall be second in priority.

Third Priority – all other AIA documents including, but not limited to, the AIA Document A201-2017 General Conditions of the Contract for Construction and the A101-2017 Standard Form of Agreement Between Owner and Contractor (when utilized) shall be third or lower in priority.

**ARTICLE 1
GENERAL PROVISIONS**

Add the following Section to Article 1:

§1.05 PARTY RELATIONS

§1.05 The Owner and their consultants, the Architect and their Consultants, and the Contractor and their Subcontractors agree to proceed with the Work on the basis of mutual trust, good faith and fair dealing.

§1.1 BASIC DEFINITIONS

§1.1.1 THE CONTRACT DOCUMENTS

§1.1.1 Delete the last sentence of this Section and substitute the following:

The Contract Documents also include the Bidding Documents (Advertisement or Invitation to Bid, Request for Quotations/Bids, Instructions to Bidders, Form of Proposal, Bid Bond and Sample Forms), Performance Bond, Payment Bond, Maintenance Bond (if applicable), Certificates of Insurance, Special Provisions For Disadvantaged and Women Business Enterprise Utilization (if bound herein).

§1.1.2 THE CONTRACT

§1.1.2 Make the following changes to Section 1.1.2:

In the last sentence, insert "and the Contractor" after "The Architect" and delete "the Architect's" and insert "their respective".

§1.2 Correlation and intent of Contract Documents

§1.2.1.1 In the second sentence, remove "any law" and insert "West Virginia law or any applicable federal law". In the last sentence, remove "by law" and insert "West Virginia law or any applicable federal law".

§1.7 Digital Data Use and Transmission

§1.7 Delete the last sentence of this section in its entirety.

§1.8 Building Information Models Use and Reliance

§ 1.8 Remove this section in its entirety and replace it with the following:

"Any use of, or reliance on, all or a portion of a building information model must be approved in advance by Owner and will only be permitted if the Parties have agreed upon and executed written documents to memorialize protocols governing the use of, and reliance on, the information contained in the model."

**ARTICLE 2
OWNER**

§2.1 GENERAL

§ 2.1.1 Add the following after the last sentence:

Notwithstanding the foregoing, the parties understand that since Owner is a government entity, change orders will often require approval by entities in addition to owner. When owner is a state agency, those entities may include, but are not limited to, the West Virginia Attorney General's Office and the West Virginia Purchasing Division. Additionally, approval may be required by agencies providing project funding, including but not limited to, West Virginia School Building Authority and agencies of the United States federal government.

§2.1.2 Delete Section 2.1.2 in its entirety.

§2.1 Add the following Section to 2.1:

§2.1.3 The Owner and the agency funding the project reserve the right to maintain a full time or part time project representative (sometimes referred to as the "Clerk of the Works") at the project site who shall keep the Owner informed of the progress and quality of the Work and responsibilities. The Contractor shall cooperate and assist the Clerk of the Works in the performance of his/her duties. The Clerk of the Works will not interfere with or be responsible for the Contractor's supervision and direction of the Work, and the Contractor's means, methods, techniques, sequences, and procedures, and for coordinating all portions of the Work. The Clerk of the Works may facilitate communications between the Owner, Architect, and Contractor but has no authority to make decisions for the Owner, approve modifications to the Contract Documents, the Contract Time, or Contract Sum. Additionally, Contractor is not permitted to rely on or consider decisions made by the Clerk of the Works on behalf of Owner

§2.2 Evidence of the Owner's Financial Arrangements: Delete § 2.2 and all of its subsections in its entirety.

§2.3 Information and Services Required of Owner

§2.3.2 Make the following changes to Section 2.3.2:

In first sentence, delete the period and add ", when required pursuant to West Virginia Code §30-12-1 et seq." Add the following sentence at the end of Section 2.3.2: "If the Owner does not retain an architect lawfully licensed to practice architecture or an entity lawfully practicing architecture in the jurisdiction where the Project is located, the Owner will appoint an individual to assume the role and obligations of the Architect pursuant to this Agreement."

§2.3.3 Delete this section in its entirety.

§2.3.4 Delete the last sentence of Section 2.3.4 and substitute the following:

The Contractor shall confirm the locations of each utility. If the Owner has provided geotechnical and other tests to determine subsurface conditions, the Owner will provide such documents to the Contractor; the Contractor acknowledges that it will make no claims for any subsurface or any other conditions revealed by these tests.

**ARTICLE 3
CONTRACTOR**

§3.2 REVIEW OF CONTRACT DOCUMENTS AND FIELD CONDITIONS BY CONTRACTOR

§3.2.2 Add the following sentence to the end of Section 3.2.2:

Claims by Contractor resulting from its failure to familiarize itself with the site shall be deemed waived. Additionally, by submitting a bid or otherwise entering into this contract, Contractor acknowledges that it has reviewed and understands the contract documents and the work required by those documents. Any claims arising from Contractor's failure to review and understand the contract documents shall be deemed waived.

§3.2.3 Delete Section 3.2.3 in its entirety and substitute the following:

§3.2.3 The Contractor acknowledges its continuing duty to review and evaluate the Construction Documents during performance of its services and shall immediately notify the Owner and the Architect about any problems, conflicts, defects, deficiencies, inconsistencies or omissions it discovers in or between the Construction Documents; and variances it discovers between the Construction Documents and applicable laws, statutes, building codes, rules and regulations.

§ 3.2.4 Add the following clauses to Section 3.2.4:

§3.2.4.1 If the Contractor performs any Work which it knows or should have known involves a recognized problem, conflict, defect, deficiency, inconsistency or omission in the Construction Documents; or a variance between the Construction Documents and requirements of applicable laws, statutes, building codes, rules and regulations, without notifying the Owner and the Architect prior to receiving written authorization from the Architect to proceed, the Contractor shall be responsible for the consequences of such performance.

§3.2.4.2 Before ordering any materials or doing any Work, the Contractor and Subcontractors shall verify all measurements at the site and shall be responsible for the correctness of same. Discrepancies shall be reported in writing to the Architect prior to proceeding with the Work. No extra charge or compensation will be

entertained due to differences between actual measurements and dimensions indicated on the drawings, if such differences do not result in a change in the scope of Work or if the Architect failed to receive written notice before the Work was performed.

§3.4 LABOR AND MATERIALS

§3.4.1 Vendor must review and comply with the following statutory requirements affecting public construction projects, as well as any other applicable laws that are not referenced herein:

- W. Va. Code § 5-19-1 et seq., relating to domestic steel preference.
- W. Va. Code § 5A-3-56 relating to domestic steel preference, provided that the Owner is a state agency subject to Chapter 5A, Article 3 of the W. Va. Code.
- W. Va. Code § §21-1C-1 et seq., relating to local hiring preference
- W. Va. Code §21-1D-1 et seq., relating to drug free workplace requirements.

§3.4 Add the following Sections to 3.4:

§3.4.4 Where materials and equipment are to be provided by the Owner under the Contract Documents, the Contractor shall notify the Owner in writing as to when materials and equipment are required on the project site in sufficient time to avoid delay in the Work.

§3.4.5 The Contractor shall employ labor on the Project or in connection with the Work, capable of working harmoniously with all trade crafts and any other individuals associated with the Project. The Contractor shall also use its best efforts and implement policies and practices to minimize the likelihood of any strike, work stoppage or other labor disturbance. Except as specifically provided in this Agreement, Contractor shall not be entitled to any adjustment in the Contract sum or Contract time and shall be liable to the Owner for all damages suffered by the Owner occurring as a result of work stoppages, slowdowns, disputes, or strikes by the work force of or provided by Contractor or its Subcontractors.

§3.5 WARRANTY

§3.5 Add the following sentence at the end of Section 3.5:

The Contractor agrees to assign to the Owner at time of Final Completion of the Work, any and all manufacturer's warranties relating to materials and labor used in the Work and further agrees to perform the Work in such a manner so as to preserve any and all such warranties.

§3.8 ALLOWANCES

§3.8.3 Make the following change to Section 3.8.3:

§3.8.3 Delete "with reasonable promptness" and insert "in sufficient time to avoid delay in the Work."

Add the following Section to 3.8:

§3.8.4 The Contractor shall promptly submit to the Owner an itemized account of any expenditure by the Contractor of the Contract allowance in sufficient detail to allow the Owner to properly account for such expenditure.

§3.9 SUPERINTENDENT/PROJECT MANAGER

§3.9.1 Add the following sentence to the end of Section 3.9.1:

The Contractor may also employ a competent project manager.

§3.9.2 Make the following changes to Section 3.9.2:

In the first sentence, add "and project manager, if applicable" after "superintendent." In the second sentence, add "or project manager, if applicable," after "superintendent."

§3.9.3 Make the following changes to Section 3.9.3:

In the first sentence, add "or project manager, if applicable," after "superintendent." In the second sentence, add "or project manager, if applicable," after "superintendent."

§3.9 Add the following Section to 3.9:

§3.9.4 The Owner shall have the right, at any time, to direct a change in the Contractor's representatives if their performance is deemed unsatisfactory.

§3.10 CONTRACTOR'S CONSTRUCTION SCHEDULES

§3.10.1 Make the following changes to Section 3.10.1:

In the first sentence, delete the word "promptly" and substitute "by the earliest reasonable date".

Add the following sentence to the end of Section 3.10.1: "The Contractor shall submit an updated construction schedule with each payment application, unless waived by the Owner."

Add the following Sections to 3.10:

§3.10.4 At any time after the first thirty (30) days of the Contract Time, if it is found that the project is two (2) weeks or more behind schedule, beyond approved time extensions, or if at any time during

the last thirty (30) days of the scheduled Contract Time the Contractor is one (1) week or more behind schedule, the Contractor shall immediately submit a plan to the Owner describing how the Work will be placed back on schedule within the remaining Contract Time.

§3.10.5 If the Owner and the Architect determine that the performance of the Work during any stage of the construction schedule last approved by the Owner has not progressed or reached the level of completion required by the Contract Documents, the Owner will have the right to order the Contractor to take corrective measures (hereinafter referred to collectively as Extraordinary Measures) necessary to expedite the progress of the Work, including, without limitation: (1) working additional shifts or overtime; (2) supplying additional manpower, equipment and facilities; and (3) other similar measures. Such Extraordinary Measures shall continue until the progress of the Work complies with the last approved construction schedule. The Owner's right to require Extraordinary Measures is solely for the purpose of ensuring the Contractor's compliance with the construction schedule after allowing for approved extensions of Contract Time as provided elsewhere in this Agreement. The Contractor is not entitled to an adjustment in the Contract Sum in connection with any Extraordinary Measures required by the Owner. The Owner may exercise its rights under this Section as frequently as the Owner deems necessary to ensure that the Contractor's performance of the Work will comply with the construction schedule.

§3.11 DOCUMENTS AND SAMPLES AT THE SITE

§3.11 Insert the following sentence at the end of Section 3.11:

The Contractor's compliance with this Section 3.11 shall be a condition precedent to any obligation of the Owner to make Final Payment pursuant to this Agreement.

§3.15 CLEANING UP

§3.15.2 Delete Section 3.15.2 in its entirety and substitute the following:

§3.15.2 If the Contractor fails to clean up as provided in the Contract Documents, the Owner may do so and may withhold such reasonable costs as necessary for the fulfillment of the Contractor's obligation under this Section 3.15. If the reasonable costs of such cleaning exceed the Contract Sum then due the Contractor, the Contractor shall reimburse the Owner the difference within thirty (30) consecutive calendar days of the Owner's written request.

Any materials, tools, supplies, or other personal property left by the Contractor shall be deemed abandoned property and the Owner shall have no obligation to hold or store the property on behalf of Contractor and may dispose of the abandoned property as if it were property of the State of West Virginia. Provided however, that prior to treating property as abandoned and disposing of it, Owner must

first provide Contractor with 10 days notice of its intent to do so. If any materials, tools, supplies or other personal property belong to a subcontractor, then Contractor is obligated to communicate this notice to its subcontractor immediately.

§3.15 Add the following Section to 3.15:

§3.15.3 In order to achieve Substantial Completion, as defined by Section 9.8, for any portion of the Work, the Contractor must have the area where the Work is located fully cleaned and all materials and/or debris removed from site. The Certificate of Substantial Completion will not be issued until the Contractor has met this obligation.

ARTICLE 4 ARCHITECT

§4.1 GENERAL

§4.2 ADMINISTRATION OF THE CONTRACT

§4.2 Make the following changes to Section 4.2:

§4.2.1 In the first sentence of Section 4.2.1 after the word Architect add ", unless otherwise indicated by the Owner,".

§4.2.2 In the first sentence of Section 4.2.2 strike the word "generally."

§4.2.3 In the first sentence of Section 4.2.3 strike the word "reasonably."

§4.2.5 Add the following sentence at the end of Section 4.2.5:

The Architect upon receipt of an Application for Payment from the Contractor shall either review and certify such amounts due for payment or return such Application for Payment to the Contractor for correction(s) within five (5) consecutive business days of receipt.

§4.2.7 Delete the first sentence of Section 4.2.7 and substitute the following:

The Architect will review and approve, or take other appropriate action upon, the Contractor's submittals such as Shop Drawings, Product Data and Samples for the purpose of checking for conformance with the Contract Documents.

Modify the second to last sentence by removing it in its entirety and replacing it with the following: The Architect's review shall not constitute approval of safety precautions or of any construction means, methods, techniques, sequences, or procedures, unless the Architect has established the required construction means, methods, techniques, sequences, or procedures, or the Contract Documents require such approval.

§4.2.8 Make the following change to Section 4.2.8:

In the first sentence, after the word Architect add ", in consultation with the Owner,".

ARTICLE 5
SUBCONTRACTORS

§5.2 Award of Subcontracts and Other Contracts for Portions of Work

§5.2.1 Add the following sentence to Section 5.2.1.

This provision in no way limits the Contractor's legal obligations to report subcontractors and labor/material suppliers under W. Va. Code § 5-22-1(f) and obtain approval under W. Va. Code § 5-22-1(g) prior to any subcontractor substitution.

§5.4 Contingent Assignment of Subcontracts: This section is removed in its entirety and replaced with the following:

§5.4 Emergency Contracts with Subcontractors:

In the event that the general contractor fails to fulfill its contractual obligations and the performance bond has failed to provide an adequate remedy, Owner has the right to execute emergency contracts with subcontractors to ensure continuation of the work, provided that doing so is in compliance with the laws, rules, and procedures governing emergency contracting authority for Owner, and the emergency contract terms comply with all other applicable laws, rules, and procedures.

ARTICLE 7
CHANGES IN THE WORK

§7.1 General

§7.1.2. In Section 7.1.2. remove the word "alone" and insert "with approval by the Owner."

§7.2 CHANGE ORDERS

§7.2 Add the following Section to 7.2:

§7.2.2 A written Change Order as defined under 7.2.1 above constitutes a final settlement of all matters relating to the change in the Work which is the subject of the Change Order, including, but not limited to general conditions, all direct or indirect costs associated with such change and any and all adjustment to the Contract Sum and Contract Time. The parties also understand and agree that if Owner is a state agency, change orders may require approval by entities in addition to Owner. Those entities may include, but are not limited to, the West Virginia Purchasing Division, and the West Virginia Attorney General's Office. Owner

and Contractor must discuss the change order approval requirements prior to executing this agreement.

Add the following section to § 7.2

§7.2.3. Allowance for Overhead and Profit: Contractor's overhead and profit for a change order issued under this Article included in the total cost to the Owner shall not exceed based on the following schedule:

.1 For the Contractor, for any Work performed by the Contractor's own forces, fifteen percent (15%) of the cost.

.2 For the Contractor, for Work performed by the Contractor's Subcontractor, ten percent (10%) of the amount due the Subcontractor.

.3 For each Subcontractor or Sub-Subcontractor involved, for any Work performed by that Subcontractor's own forces, fifteen percent (15%) of the cost.

.4. For each Subcontractor, for Work performed by the Subcontractor's Sub-subcontractors, ten percent (10%) of the amount due the Sub-subcontractor.

.5 Cost to which overhead and profit is to be applied shall be determined in accordance with Section 7.3.7. Estimated labor hours shall include hours only for those workmen and working foremen directly involved in performing the Change Order work. Supervision above the level of working foremen (such as general foremen, superintendent, project manager, etc.) is considered to be included in the allowance for Overhead and Profit. Hand tools are defined as equipment with a value of \$1,000 or less. For Contractor owned equipment, the "bare" equipment rental rates allowed to be used for pricing Change Order proposals shall be not more than the monthly rate listed in the most current publication of The AED Green Book divided by 176 to arrive at a maximum hourly rate to be applied to the hours the equipment is used performing the Change Order work.

.6 In order to facilitate checking of quotations for extras or credits, all proposals, except those so minor that their propriety can be seen by inspection, shall be accompanied by a complete itemization of costs including labor, material, equipment and Subcontractors. Details to be submitted will include detailed line item estimates showing detailed materials quantity take-offs, material prices by item and related labor hour pricing information and extensions (by line item or by drawing as applicable.) Where major cost items are Subcontracts, they shall also be itemized as prescribed above. In no case will a change involving over \$10,000 be approved without such an itemization.

.7 Local Business and Occupation Taxes, if applicable, shall be calculated on the cost of the Work, overhead and profit.

.8 Overhead and profit shall not be calculated on changes in the Work involving unit prices. Unit prices are to have overhead and profit included in the price quoted.

.9 Under no circumstances is Contractor permitted to charge for the passage of time (often referred to as general conditions or winter conditions) without an identified, itemized, and concretely provable cost borne by Contractor. Contractor has a duty to mitigate costs during a delay period to the fullest extent possible and Contractor will not be paid for costs that could have been mitigated. Calculating a daily delay rate without properly identifying, itemizing, and proving actual, unmitigateable costs, is prohibited. Contractor understands and accepts that it has the responsibility to prove that costs could not be mitigated prior to submitting a request for payment.

§7.3 CONSTRUCTION CHANGE DIRECTIVES

§7.3.4 Make the following change in Section 7.3.4:

In the fourth line of the first sentence, delete the words "an amount for overhead and profit as set forth in the Agreement, or if no such amount is set forth in the Agreement, a reasonable amount" and substitute "an allowance for overhead and profit in accordance with clauses 7.3.11.1 through 7.3.11.9 below."

§7.3.7 Delete the word "recorded" and replace it with "processed".

§7.3.9 Delete Section 7.3.9 in its entirety and substitute the following:

§7.3.9 Pending final determination of the total cost of a Construction Change Directive to the Owner, amounts not in dispute for such changes in the Work shall be included in Applications for Payment provided these amounts have been added to the Contract by Change Order and a purchase order has been issued for the Change Order.

§7.3.10 Add the following sentence to the end of Section 7.3.10:

The Parties will utilize their best efforts to issue a change order within 60 days of agreement being reached, but failure to do so will not give rise to grounds for contract cancellation, penalties, or any other cause of action.

Add the following Section to 7.3:

§7.3.11 In Section 7.3.7, the allowance for overhead and profit for a change directive issued under this Article included in the total cost to the Owner shall not exceed the following schedule:

.1 For the Contractor, for any Work performed by the Contractor's own forces, fifteen percent (15%) of the cost.

.2 For the Contractor, for Work performed by the Contractor's Subcontractor, ten percent (10%) of the amount due the Subcontractor.

.3 For each Subcontractor or Sub-Subcontractor involved, for any Work performed by that Subcontractor's own forces, fifteen percent (15%) of the cost.

.4. For each Subcontractor, for Work performed by the Subcontractor's Sub-subcontractors, ten percent (10%) of the amount due the Sub-subcontractor.

.5 Cost to which overhead and profit is to be applied shall be determined in accordance with Section 7.3.7. Estimated labor hours shall include hours only for those workmen and working foremen directly involved in performing the Change Order work. Supervision above the level of working foremen (such as general foremen, superintendent, project manager, etc.) is considered to be included in the allowance for Overhead and Profit. Hand tools are defined as equipment with a value of \$1,000 or less. For Contractor owned equipment, the "bare" equipment rental rates allowed to be used for pricing Change Order proposals shall be not more than the monthly rate listed in the most current publication of The AED Green Book divided by 176 to arrive at a maximum hourly rate to be applied to the hours the equipment is used performing the Change Order work.

.6 In order to facilitate checking of quotations for extras or credits, all proposals, except those so minor that their propriety can be seen by inspection, shall be accompanied by a complete itemization of costs including labor, material, equipment and Subcontractors. Details to be submitted will include detailed line item estimates showing detailed materials quantity take-offs, material prices by item and related labor hour pricing information and extensions (by line item or by drawing as applicable.) Where major cost items are Subcontracts, they shall also be itemized as prescribed above. In no case will a change involving over \$10,000 be approved without such an itemization.

.7 Local Business and Occupation Taxes, if applicable, shall be calculated on the cost of the Work, overhead and profit.

.8 Overhead and profit shall not be calculated on changes in the Work involving unit prices. Unit prices are to have overhead and profit included in the price quoted.

.9 Under no circumstances is Contractor permitted to charge for the passage of time (often referred to as general conditions or winter conditions) without an identified, itemized, and concretely provable cost borne by Contractor. Contractor has a duty to mitigate costs during a delay period to the fullest extent possible and Contractor will not be paid for costs that could have been mitigated. Calculating a daily delay rate

without properly identifying, itemizing, and proving actual, unmitigateable costs, is prohibited. Contractor understands and accepts that it has the responsibility to prove that costs could not be mitigated prior to submitting a request for payment.

§7.4 Minor Changes in Work. Insert the following sentence at the end of section 7.4:

"Contractor may request that Architect provide written confirmation that Owner has agreed to the minor change, and if requested, Architect will provide it."

ARTICLE 8 TIME

§8.3 DELAYS AND EXTENSIONS OF TIME

§8.3.1 In the first sentence, delete "unusual delay in deliveries," and add "unmitigatable costs attributable to" before the words "adverse weather conditions."

ARTICLE 9 PAYMENTS AND COMPLETION

§9.1 Contract Sum

§9.1.2 Add the following sentence to the end of section 9.1.2:

"Any equitable adjustment of unit prices must be processed as a change order to the contract"

§9.2 SCHEDULE OF VALUES

§9.2 Make the following changes to Section 9.2:

In the first sentence add "and the Owner" after the first reference to the Architect. In the second sentence add "or the Owner" after Architect. Remove the last sentence in its entirety and replace it with the following:

"Any changes to the schedule of values shall be submitted to the Architect and the Owner and supported by such data to substantiate its accuracy as the Architect or owner may require. This schedule, unless objected to by the Architect or the Owner, shall be used as a basis for reviewing the Contractor's subsequent Applications for Payment."

§9.3 APPLICATIONS FOR PAYMENT

§9.3 Make the following changes to Section 9.3:

§9.3.1 In the first sentence add "and the Owner" after the first reference to the Architect and add "and other required documents" after the words "schedule of values."

§9.3.1.1 Delete clause 9.3.1.1 in its entirety and substitute the following:

§9.3.1.1 Such applications may include requests for payment on account of changes in the Work authorized by Construction Change Directives and Change Orders only after a purchase order has been issued for the Work affected.

§9.3.1 Add the following clauses to Section 9.3.1:

§9.3.1.3 Until the Work is fifty percent (50%) complete, the Owner will withhold as retainage 10% of the amount due the Contractor on account of progress payments. At the time the Work is fifty percent (50%) complete and thereafter, if the manner of completion of the Work and its progress are and remain satisfactory to the Owner and Architect, and in the absence of other good and sufficient reasons, the Architect will, on presentation by the Contractor of Consent of Surety, authorize any remaining partial payments to be paid in full.

§9.3.1.4 The full Contract retainage may be reinstated if the manner of completion of the Work and its progress do not remain satisfactory to the Owner and Architect, if the Surety withholds its consent, or for other good and sufficient reasons.

§9.4 CERTIFICATES FOR PAYMENT

§9.4.1 After the phrase "in the full amount of the Application for Payment," insert the phrase "less any retainage withheld pursuant to section 9.3.1.3,".

§9.6 PROGRESS PAYMENTS

§9.6.7 Delete Section 9.6.7 in its entirety.

§9.6.8 Delete Section 9.6.8 in its entirety.

§9.7 FAILURE OF PAYMENT

§9.7 Make the following changes in Section 9.7:

In line two, change "seven days" to "sixty days." In line four, delete "binding dispute resolution" and substitute "the West Virginia Claims Commission"

§9.8 SUBSTANTIAL COMPLETION

§9.8.3 Add the following clause to Section 9.8.3:

If Architect is required to perform more than one inspection under this subsection, Contractor shall be responsible for paying the Owner for the cost of the additional inspection, which will be paid by Owner to Architect, at the hourly rate established in the contract between Owner and Architect.

§9.8.5 Add the following clause to Section 9.8.5:

§9.8.5.1 The payment of retainage shall be sufficient to increase the total payments to ninety-five percent (95%) for the Work or designated portion thereof being accepted as Substantially Complete, less any amounts as the Architect shall determine for any Work that is not complete, not in accordance with the Contract Documents, or for unsettled claims.

§9.10 FINAL COMPLETION AND FINAL PAYMENT

§9.10.1 Add the following to the end of Section 9.10.1:

If Architect is required to perform more than one inspection under this subsection, Contractor shall be responsible for paying the Owner for the cost of the additional inspection, which will be paid by Owner to Architect, at the hourly rate established in the contract between Owner and Architect.

§9.10.2 Make the following changes in Section 9.10.2:

In the first sentence, delete "for which the Owner or the Owner's property might be responsible or encumbered (less amounts withheld by Owner)."

Add the following clause to Section 9.10.2:

§9.10.2.1 Before final payment is due the Contractor, all applicable State and local taxes must be paid. If requested by the Owner, the Contractor shall present evidence that payment or satisfaction of all such tax obligations has been made.

§9.10.3 Add the following clause to Section 9.10.3:

9.10.3.1 Unless and to the extent final completion is delayed through no fault of the Contractor as provided in Section 9.10.3, the Owner shall be under no obligation to increase payments above ninety-five percent (95%) until final completion of the Work is Certified by the Architect.

§9.10.4 Make the following changes in Section 9.10.4:

In the first sentence, delete the word "the" and replace it with "Unless and until the Contractor makes a subsequent Claim against the Owner, the".

Add the following as the last sentence. "Neither the Owner's offer of a final payment nor its acceptance by the Contractor shall legally prevent or limit the Owner's right to assert any and all counterclaims in litigation filed by the Contractor as allowed in section 15.1.8."

Add the following Sections to Article 9:

§9.11 LIQUIDATED DAMAGES

§9.11.1 The Owner will suffer financial loss if the Work is not Substantially Complete within the Contract Time as defined in Article 8, and if final completion is not achieved within the specified time frame following Substantial Completion. As liquidated damages, and not as a penalty, the Contractor and the Contractor's surety shall be liable for and shall pay the Owner the sum(s) stated in this Agreement and/or purchase order.

§9.11.2 Allowances may be made for delays due to shortages of materials and/or energy resources, subject to proof by documentation, and also for delays due to strikes or other delays beyond the control of the Contractor. All delays and any claim for extension of Contract Time must be properly documented in accordance with Section 15.1.5 by the Contractor and must be made within the time limits stated in Section 15.1.2.

**ARTICLE 10
PROTECTION OF PERSONS AND PROPERTY**

§10.2.8 INJURY OR DAMAGE TO PERSON OR PROPERTY

§10.2.8 Make the following changes to Section 10.2.8:

In the first sentence, delete "within a reasonable time not exceeding 21 days" and substitute "immediately".

§10.3 HAZARDOUS MATERIALS

§10.3.3 Delete Section 10.3.3 in its entirety.

**ARTICLE 11
INSURANCE AND BONDS**

§11.1 CONTRACTOR'S LIABILITY INSURANCE

§11.1.2 Add the following to the end of §11.1.2.

At a minimum the Contract shall provide, at the Contractor's Expense:

§11.1.2.1. a Performance Bond and a Labor and Material Payment Bond for 100% of the Contract Sum and, if applicable, a two-year roofing Maintenance Bond for the full value of the roofing system.

§11.1.2.2 An attorney-in-fact who executes the bonds on behalf of the surety shall affix thereto a certified and current copy of power of attorney.

§11.1.2.3 The bonds shall be issued on State of West Virginia forms. The Contractor shall deliver the required bonds and all other contract documents to the Owner not later than 15 days following receipt of the Owner's notice of intent to award a Contract.

§11.2 Owner's Insurance Delete section 11.2 in its entirety.

§11.4 Loss of Use, Business Interruption, and Delay in Completion Insurance

§11.4 Section 11.4 is deleted in its entirety.

§11.5.1 Make the following changes in Section 11.5.1:

In the first sentence, substitute "Contractor" for "Owner" each time the latter word appears.

§11.5.2 Delete Section 11.5.2 in its entirety and substitute the following:

§11.5.2 Prior to settlement of insured loss, the Contractor shall notify the parties of the terms of the proposed settlement as well as the proposed allocation of the insurance proceeds. The parties shall have 14 days from the receipt of notice to object. If no objection is made, the Contractor shall proceed as proposed and allocate the settlement accordingly. If such objection is made, the dispute shall be resolved as provided in Section 15.4. The Contractor, in that case, shall make settlement with insurers in accordance with directions of the Court. If distribution of the insurance proceeds as directed by the Court is required, the Court will direct such distribution. Any work to repair the damage will be incorporated into the contract as a change order.

ARTICLE 13 MISCELLANEOUS PROVISIONS

§13.4 TESTS AND INSPECTIONS

§13.4.1 Remove the phrase "so require" and insert in its place "prohibit delegation of the test to Contractor"

§13.6 INTEREST

§13.6 Delete Section 13.5 in its entirety and substitute the following:

Notwithstanding any other provision in the Contract Documents, West Virginia Code does not authorize the payment of interest on late payments. Accordingly, interest charges for late payment are prohibited.

Add the following Sections to Article 13:

§13.6 WORKERS COMPENSATION

The Contractor shall provide proof of compliance with West Virginia Worker's Compensation laws and regulations.

§13.7 CONTRACTOR'S LICENSE

§13.7.1 West Virginia Code §21-11-2 requires that all persons desiring to perform contractual work in West Virginia shall be duly licensed. The West Virginia Contractor's Licensing Board is empowered to issue a contractor's license.

§13.7.2 West Virginia Code §21-11-11 requires any prospective Bidder to include the Bidder's contractor's license number on its Bid. The successful Bidder will be required to furnish a copy of its contractor's license in a classification appropriate to the Work prior to issuance of a purchase order/contract.

ARTICLE 14 TERMINATION OR SUSPENSION OF THE CONTRACT

§14.1 TERMINATION BY THE CONTRACTOR

§14.1.1 Make the following changes in Section 14.1.1:

At the end of clause 14.1.1.3 delete "; or" and insert a period.

Delete clause 14.1.1.4 in its entirety.

§14.1.3 Delete Section 14.1.3 in its entirety and substitute the following:

§14.1.3 If one of the reasons described in Section 14.1.1 or 14.1.2 exist, the Contractor may, upon seven days written notice to the Owner and Architect, terminate the Contract. In such event, the Contractor shall be paid for all Work performed in accordance with the Contract Documents, for reasonable and proven termination expenses and a reasonable allowance for overhead and profit. However, such payment, exclusive of termination expenses, shall not exceed the Contract Sum as reduced by other payments made to the Contractor and further reduced by the value of Work as yet not completed. The Contractor shall be entitled to reasonable overhead, but not profit, on Work not performed.

§14.2 TERMINATION BY THE OWNER FOR CAUSE

§14.2.4 Delete Section 14.2.4 in its entirety and substitute the following:

§14.2.4 If the unpaid balance of the Contract Sum exceeds the cost of finishing the Work, including compensation for the Architect's services and expenses made necessary thereby, and other

damages incurred by the Owner and not expressly waived, such excess shall not be paid to the Contractor. If such costs and damages exceed the unpaid balance, the Contractor shall pay the difference to the Owner. The amount to be paid to the Owner shall be certified by the Initial Decision Maker, upon application, and this obligation for payment shall survive termination of the Contract.

§14.4 TERMINATION BY THE OWNER FOR CONVENIENCE

§14.4.1 Delete Section 14.4.1 in its entirety and substitute the following:

§14.4.1 The Owner may, at any time, terminate the Contract for the Owner's convenience and without cause upon thirty days written notice.

§14.4.3 Delete Section 14.4.3 in its entirety and substitute the following:

§14.4.3 In case of such termination for the Owner's convenience, the Contractor shall be entitled to receive payment from the Owner on the same basis provided in Section 14.1.3 above.

Add the following Section to Article 14:

§14.5 FISCAL YEAR FUNDING

§14.5 Work performed under this Contract is to continue in the succeeding fiscal year contingent upon funds being appropriated by the Legislature for this Work. In the event funds are not appropriated for this Work, this Contract becomes of no effect and is null and void after June 30.

**ARTICLE 15
CLAIMS AND DISPUTES**

§15.1 Claims

§15.1.2 TIME LIMITS ON CLAIMS

§15.1.2 Delete Section 15.1.2 in its entirety and substitute the following:

Any applicable statute of limitations shall be in accordance with West Virginia Code.

§15.1.3 NOTICE OF CLAIMS Add the following to § 15.1.3:

§15.1.3.3 All claims, and notice of claims that require an increase in contract time, contract scope, or contract sum must be made in writing.

§ 15.1.8 is added to the Contract as follows:

§ 15.1.8 Counterclaims – In the event that Contractor makes a claim, Owner reserves the right to make a counterclaim and will not be barred from doing so even if final payment has been made.

§15.2 INITIAL DECISION

§15.2.1 In the third sentence of Section 15.2.1, insert "or litigation" following the word "mediation" and remove the phrase "binding dispute resolution" and replace it with "or litigation".

§15.2.5 Delete the last sentence in Section 15.2.5 and substitute the following:

Approval or rejection of a claim by the Initial Decision Maker shall be final and binding on the parties unless it is pursued further by either party in accordance with Section 15.2.6.

§15.2.6 Make the following change to clause 15.2.6.1:

In the last sentence, delete "or pursue binding dispute resolution proceedings."

§15.2.8 Delete Section 15.2.8 in its entirety.

§15.3 MEDIATION

§15.3.1 Delete "binding dispute resolution" and substitute "litigation in a court of competent jurisdiction."

§15.3.2 Delete Section 15.3.2 in its entirety and substitute the following:

§15.3.2 The parties shall endeavor to resolve their Claims by non-binding mediation which, unless the parties mutually agree otherwise, shall be administered by the American Arbitration Association in accordance with its Construction Industry Mediation Procedures in effect on the date of the Agreement.

§ 15.3.3 Remove section 15.3.3 in its entirety

§15.4 ARBITRATION

§15.4 Delete Section 15.4 in its entirety and substitute the following:

§15.4 SETTLEMENT OF CLAIMS

§15.4.1 The Constitution of West Virginia grants the State sovereign immunity from any and all Claims against the public treasury. This immunity applies and is extended to all agencies of the State, including the Owner. It shall be in full force and effect as it relates to this Contract. The West Virginia Legislature, recognizing that certain Claims against the State may constitute a moral obligation of the State and should be heard, has established the West Virginia Claims Commission for this purpose. The Parties understand that this sovereign immunity and the Constitution of the

State of West Virginia prohibit the State and Owner, from entering into binding arbitration. Notwithstanding any provision to the contrary in the Contract Documents, all references to arbitration, regardless of whether they are included in the AIA Document A201-2017 or another related document are hereby deleted and all Claims of the Contractor for monetary relief, and only of the Contractor, arising out of or related to this Contract shall be decided by the West Virginia Claims Commission. The following Sections have been rewritten to bring them into conformance with the foregoing.

§15.4.2 Claims by the Owner may be brought against the Contractor in the Circuit Court of Kanawha County, West Virginia, or in any other court that has jurisdiction, as the Owner may elect.

§15.4.3 Any Claim arising out of or related to the Contract, except Claims relating to aesthetic effect and except those waived as provided for in Sections 15.1.6, 9.10.4 and 9.10.5, shall, within 30 days after submission of the decision by the Initial Decision Maker, be settled for the Contractor by the West Virginia Claims Commission or, for the Owner, by the Circuit Court of Kanawha County or any other court of jurisdiction as the Owner may elect.

§15.4.4 Notice of such action shall be filed in writing with the other party to the Contract, and a copy of such notice shall be filed with the Initial Decision Maker and the Architect, if applicable.

§15.4.5 During court proceedings, the Owner and the Contractor shall comply with Section 15.1.3.

§15.4.6 Claims shall be made within the time limits specified in Section 15.2.6.1.

§15.4.7 The party filing a Claim must assert in the demand all Claims then known to that party on which action is permitted.

Add the following Article:

ARTICLE 16
EQUAL OPPORTUNITY

§16.1 COMPLIANCE WITH REGULATIONS UNDER TITLE VI OF THE FEDERAL CIVIL RIGHTS ACT OF 1964 AND EXECUTIVE ORDER 65-2 BY THE GOVERNOR OF WEST VIRGINIA DATED DECEMBER 15, 1965

§16.1.1 The Contractor agrees that it will comply with Title VI of the Federal Civil Rights Act of 1964 (P.L. 88352) and the regulations of the State of West Virginia, to the end that no person in the State, or in the United States, shall on the grounds of race, color, or national origin, be excluded from participation in, be denied the benefits of, or otherwise subjected to discrimination under any program or activity for which the Contractor receives any recompense or other consideration of value, either directly or indirectly from the State; and HEREBY GIVES ASSURANCE THAT it will immediately take any measures necessary to effectuate this Agreement.

§16.1.2 If any real property or structure thereon is provided or improved, this assurance shall obligate the Contractor, or in the case of any transfer of such property, any transferee, for the period during which the real property or structure is used for a purpose for which any State payment is extended or for another purpose involving the provision of similar services or benefits. If any other goods or services are so provided, this assurance shall obligate the Contractor for the period during which it supplies such goods or services.



§16.1.3 The Contractor recognizes and agrees that such right to provide property, goods or services to the State will be extended in reliance on the representations and agreements made in assurance, and that the State shall have the right to seek judicial enforcement of this assurance. This is binding on the Contractor, its successors, transferee, and assignee, or any authorized person on behalf of the Contractor.

END OF SUPPLEMENTARY CONDITIONS TO AIA DOCUMENT A201-2017

Any provisions of the Contract Documents that conflict with these Supplementary Conditions shall be null and void unless they have been approved in writing by the applicable State purchasing officer and the Attorney General, and are clearly identified as such in the bid documents.

The Owner and Contractor hereby agree to the full performance of the covenants contained herein.

IN WITNESS WHEREOF, the Owner and Contractor have entered into this Agreement as of the effective date as stated in the A101-2017 (when utilized) or other Contract Documents.

Owner:		Contractor:	
By:	for LTC Michael Beckner	By:	Mark Allen
Title:	CFMO	Title:	Chief Operating Officer - Wolf Creek Contracting Company, LLC
Date:	9/21/22	Date:	September 20, 2022



This Supplementary Conditions to AIA Document A201-2017, General Conditions of the Contract for Construction, has been approved as to form on this 20th day of February, 2019, by the West Virginia Attorney General's office as indicated in the signature line below. Any modification of this document is void unless expressly approved in writing by the West Virginia Attorney General's Office.

PATRICK MORRISEY, ATTORNEY GENERAL

BY: 
 DEPUTY ATTORNEY GENERAL

BID FORM FOR CONSTRUCTION CONTRACT

The terms used in this Bid with initial capital letters have the meanings stated in the Instructions to Bidders, the General Conditions, and the Supplementary Conditions.

09/01/22 13:03:42
WV Purchasing Division

ARTICLE 1—OWNER AND BIDDER

*WV Army National Guard
1707 Coonskin Drive
Charleston, WV 25311*

- 1.01 The undersigned Bidder proposes and agrees, if this Bid is accepted, to enter into an Agreement with Owner in the form included in the Bidding Documents to perform all Work as specified or indicated in the Bidding Documents for the prices and within the times indicated in this Bid and in accordance with the other terms and conditions of the Bidding Documents.

ARTICLE 2—ATTACHMENTS TO THIS BID

- 2.01 The following documents are submitted with and made a condition of this Bid:
- A. Bid Opening Requirements

ARTICLE 3—BASIS OF BID—LUMP SUM BID AND UNIT PRICES

GENERAL

The Bidder shall take notice of and shall be responsible for any local or state taxes levied and applicable, and the cost for the same shall be included as part of the submitted Bid.

The total Bid cost stated includes a complete operating installation including furnishing and installation of any and all changes or additions in plans, piping, mechanical work, additional electrical work, accessories, controls, etc. necessary to accommodate alternative equipment systems or materials used in construction.

BID PROPOSAL

The Bidder agrees to perform all required Work described in the detailed Specifications and as shown on the Plans for the complete construction and placing in satisfactory operation the Williamstown AASF#1 Taxiway and Apron Repairs. The Project "Sequence of Construction" has been detailed in the Drawings and Specification Division 1, Project Summary, Section 011000. The Bidder agrees to perform all the Work proposed for the total of the following Bid prices.

- 3.01 *Lump Sum Bids*
- A. Bidder will complete the Work in accordance with the Contract Documents for the lump sum (stipulated) price(s), together with any Unit Prices indicated in Paragraph 3.02 and shown in the bid schedule.
 - B. Lump Sum Bids may be one of the following:
 - 1. Lump Sum Price (Base Bid and Alternates)

3.02 *Unit Price Bids*

- A. Bidder will perform the following Work at the indicated unit prices as shown in the Bid Schedule.
- B. Bidder acknowledges that:
 - 1. each Bid Unit Price includes an amount considered by Bidder to be adequate to cover Contractor's overhead and profit for each separately identified item, and
 - 2. estimated quantities are not guaranteed, and are solely for the purpose of comparison of Bids, and final payment for all Unit Price Work will be based on actual quantities, determined as provided in the Contract Documents.

3.03 *Total Bid Price (Lump Sum and Unit Prices)*

BID SCHEDULE

**PROPOSED
WILLIAMSTOWN AASF #1 TAXIWAY AND APRON REPAIRS
FOR THE
WV ARMY NATIONAL GUARD
WOOD COUNTY, WEST VIRGINIA**

NOTE: Bid PRICE amounts are to be shown in both words and figures. In case of discrepancy, the amount shown in words will govern. Bids shall include sales tax and all other applicable taxes and fees.

Item #	Qty.	UNIT	DESCRIPTION	UNIT PRICE	UNIT PRICE WRITTEN IN WORDS	TOTAL PRICE
1	1	LS	Mobilization	46,000.00	Forty Six Thousand ⁰⁰ / ₁₀₀	46,000.00
2	260	LF	Silt Fence	3.00	Three ⁰⁰ / ₁₀₀	780.00
3	210	CY	Undercut	140.00	One hundred Forty ⁰⁰ / ₁₀₀	29,400.00
4	2,500	LF	Joint Sealing	7.00	Seven ⁰⁰ / ₁₀₀	17,500.00
5	550	LF	4" Underdrain	32.00	Thirty Two ⁰⁰ / ₁₀₀	17,600.00

Item #	Qty.	UNIT	DESCRIPTION	UNIT PRICE	UNIT PRICE WRITTEN IN WORDS	TOTAL PRICE
6	550	LF	4" Solid Outlet Pipe	30.00	Thirty	16,500.00
7	25	LF	12" Trench Drain	377.00	Three hundred Seventy Seven	9,425.00
8	3,800	SY	Concrete (Replacement)	170.00	One hundred Seventy	646,000.00
9	270	SY	Asphalt Replacement	185.00	One hundred Eighty Five	49,950.00
10	350	CY	Crushed Aggregate	175.00	One hundred Seventy Five	61,250.00
11	1	LS	Striping	38,000.00	Thirty Eight Thousand	38,000.00

TOTAL BID: nine hundred Thirty Two Thousand Four hundred
 (Words)
and Five dollars. (\$ 932,405.00)
 (Words) (Figures)

(Amounts are to be shown in both words and figures. In case of discrepancy, the amount shown in words will govern.)

ADDITIVE ALTERNATE #1 - MAIN RAMP

Item #	Qty.	UNIT	DESCRIPTION	UNIT PRICE	UNIT PRICE WRITTEN IN WORDS	TOTAL PRICE
12	800	SY	Concrete Replacement	170.00	one hundred Seventy	136,000.00
13	70	CY	Crushed Aggregate	175.00	One hundred Seventy Five	12,250.00

TOTAL ADDITIVE ALTERNATE #1 BID: One hundred Forty Eight Thousand Two
 (Words)
hundred Fifty dollars. (\$ 148,250.00)
 (Words) (Figures)

ADDITIVE ALTERNATE #2 - Hanger

Item #	Qty.	UNIT	DESCRIPTION	UNIT PRICE	UNIT PRICE WRITTEN IN WORDS	TOTAL PRICE
14	310	SY	Concrete Replacement	170.00	One hundred Seventy	52,700.00
15	30	CY	Crushed Aggregate	175.00	One hundred Seventy Five	5,250.00

TOTAL ADDITIVE ALTERNATE #2 BID: Fifty Seven Thousand nine hundred
 (Words)
Fifty dollars (\$ 57,950.00)
 (Words) (Figures)

ADDITIVE ALTERNATE #3 - Taxiway

Item #	Qty.	UNIT	DESCRIPTION	UNIT PRICE	UNIT PRICE WRITTEN IN WORDS	TOTAL PRICE
16	320	SY	Concrete Replacement	170. ⁰⁰	One hundred Seventy	54,400. ⁰⁰
17	30	CY	Crushed Aggregate	175. ⁰⁰	One hundred Seventy Five	5,250. ⁰⁰

TOTAL ADDITIVE ALTERNATE #3 BID: Fifty Nine Thousand Six hundred fifty
 (Words)
dollars. (\$ 59,650.⁰⁰)
 (Words) (Figures)

(Amounts are to be shown in both words and figures. In case of discrepancy, the amount shown in words will govern.)