

Exhibit A Pricing Page

CRFQ DOT2000000026

STEEL DOUBLE DRUM VIBRATORY ROLLER (7020EC03)

Item No.	Description:	Make/Model & Year	Estimated Unit Quantity	Unit Price	Total Cost
1	Steel Double Drum Vibratory Roller	VOLVO DD105 2020	15	\$103,341.00	\$1,550,115.00
Total Bid Amount 					\$1,550,115.00

Vendor Information

Company Name: RUDD EQUIPMENT COMPANY

Contract Manager: RON JACOBS

Address: PO BOX 610, NITRO, WV 25143

Phone: 304-755-7788

Fax: 304-755-7990

Email: RJACOBS@RUDDEQUIPMENT.COM

Signature: *Ron Jacobs*

RECEIVED

2019 OCT -8 AM 9:58

WV PURCHASING
DIVISION



Purchasing Division
 2019 Washington Street East
 Post Office Box 50130
 Charleston, WV 25305-0130

State of West Virginia
 Request for Quotation
 13 - Equipment

Proc Folder: 616608

Doc Description: ADDENDUM 1 STEEL DOUBLE DRUM VIBRATORY ROLLER (7020EC03)

Proc Type: Central Master Agreement

Date Issued	Solicitation Closes	Solicitation No	Version
2019-09-27	2019-10-08 13:30:00	CRFQ 0803 DOT2000000026	2

BID RECEIVING LOCATION

BID CLERK
 DEPARTMENT OF ADMINISTRATION
 PURCHASING DIVISION
 2019 WASHINGTON ST E
 CHARLESTON WV 25305
 US

VENDOR

Vendor Name, Address and Telephone Number:

RUDD EQUIPMENT COMPANY
 PO BOX 610
 NITRO, WV 25143

FOR INFORMATION CONTACT THE BUYER

Crystal G Hustead
 (304) 558-2402
 crystal.g.hustead@wv.gov

Signature X

FEIN #

61-0445955

DATE

10/8/19

All offers subject to all terms and conditions contained in this solicitation

ADDITIONAL INFORMATION:

THE STATE OF WEST VIRGINIA PURCHASING DIVISION FOR THE AGENCY, WEST VIRGINIA DIVISION OF HIGHWAYS, IS SOLICITING BIDS TO ESTABLISH AN OPEN-END CONTRACT FOR STEEL DOUBLE DRUM VIBRATORY ROLLER PER THE ATTACHED DOCUMENTS.

QUESTIONS REGARDING THE SOLICITATION MUST BE SUBMITTED IN WRITING TO CRYSTAL.G.HUSTEAD@WV.GOV PRIOR TO THE QUESTION PERIOD DEADLINE CONTAINED IN THE INSTRUCTIONS TO VENDORS SUBMITTING BIDS.

INVOICE TO	SHIP TO
DIVISION OF HIGHWAYS EQUIPMENT DIVISION RT 33 83 BRUSHY ROAD CROSSING, PO BOX 610 BUCKHANNON WV26201 US	DIVISION OF HIGHWAYS EQUIPMENT DIVISION 83 BRUSHY FORK RD CROSSING BUCKHANNON WV 26201 US

Line	Comm Ln Desc	Qty	Unit Issue	Unit Price	Total Price
1	CLASS 592 STEEL DOUBLE DRUM VIBRATORY ROLLER	15.00000	EA	103,341	\$1,550,115

Comm Code	Manufacturer	Specification	Model #
22101505	VOLVO	ROLLER	DD105

Extended Description :

CLASS 592 STEEL DOUBLE DRUM VIBRATORY ROLLER

SCHEDULE OF EVENTS

Line	Event	Event Date
1	MANDATORY PRE-BID MEETING	2019-09-12
2	VENDOR QUESTION DEADLINE	2019-09-23

ADDENDUM ACKNOWLEDGEMENT FORM
SOLICITATION NO.: DOT200000026

Instructions: Please acknowledge receipt of all addenda issued with this solicitation by completing this addendum acknowledgment form. Check the box next to each addendum received and sign below. Failure to acknowledge addenda may result in bid disqualification.

Acknowledgment: I hereby acknowledge receipt of the following addenda and have made the necessary revisions to my proposal, plans and/or specification, etc.

Addendum Numbers Received:

(Check the box next to each addendum received)

- | | |
|--|--|
| <input checked="" type="checkbox"/> Addendum No. 1 | <input type="checkbox"/> Addendum No. 6 |
| <input type="checkbox"/> Addendum No. 2 | <input type="checkbox"/> Addendum No. 7 |
| <input type="checkbox"/> Addendum No. 3 | <input type="checkbox"/> Addendum No. 8 |
| <input type="checkbox"/> Addendum No. 4 | <input type="checkbox"/> Addendum No. 9 |
| <input type="checkbox"/> Addendum No. 5 | <input type="checkbox"/> Addendum No. 10 |

I understand that failure to confirm the receipt of addenda may be cause for rejection of this bid. I further understand that any verbal representation made or assumed to be made during any oral discussion held between Vendor's representatives and any state personnel is not binding. Only the information issued in writing and added to the specifications by an official addendum is binding.

RUDD EQUIPMENT COMPANY

Company

Lon Faulkner

Authorized Signature

10/8/19

Date

NOTE: This addendum acknowledgement should be submitted with the bid to expedite document processing.

Revised 6/8/2012

REQUEST FOR QUOTATION
CRFQ DOT2000000026
(WVDOH CLASS 592) Steel Double Drum Vibratory Roller (7020EC03)

8.2 Reports: Vendor shall provide quarterly reports and annual summaries to the Agency showing the Agency's items purchased, quantities of items purchased, and total dollar value of the items purchased. Vendor shall also provide reports, upon request, showing the items purchased during the term of this Contract, the quantity purchased for each of those items, and the total value of purchases for each of those items. Failure to supply such reports may be grounds for cancellation of this Contract.

8.3 Contract Manager: During its performance of this Contract, Vendor must designate and maintain a primary contract manager responsible for overseeing Vendor's responsibilities under this Contract. The Contract manager must be available during normal business hours to address any customer service or other issues related to this Contract. Vendor should list its Contract manager and his or her contact information below.

Contract Manager: RON JACOBS
Telephone Number: 304-755-7788
Fax Number: 304-755-7990
Email Address: RJACOBS@RUDDEQUIPMENT.COM

ADDENDUM ACKNOWLEDGEMENT FORM
SOLICITATION NO.: CRFQ DOT2000000026

Instructions: Please acknowledge receipt of all addenda issued with this solicitation by completing this addendum acknowledgment form. Check the box next to each addendum received and sign below. Failure to acknowledge addenda may result in bid disqualification.

Acknowledgment: I hereby acknowledge receipt of the following addenda and have made the necessary revisions to my proposal, plans and/or specification, etc.

Addendum Numbers Received:

(Check the box next to each addendum received)

- | | |
|--|--|
| <input checked="" type="checkbox"/> Addendum No. 1 | <input type="checkbox"/> Addendum No. 6 |
| <input type="checkbox"/> Addendum No. 2 | <input type="checkbox"/> Addendum No. 7 |
| <input type="checkbox"/> Addendum No. 3 | <input type="checkbox"/> Addendum No. 8 |
| <input type="checkbox"/> Addendum No. 4 | <input type="checkbox"/> Addendum No. 9 |
| <input type="checkbox"/> Addendum No. 5 | <input type="checkbox"/> Addendum No. 10 |

I understand that failure to confirm the receipt of addenda may be cause for rejection of this bid. I further understand that any verbal representation made or assumed to be made during any oral discussion held between Vendor's representatives and any state personnel is not binding. Only the information issued in writing and added to the specifications by an official addendum is binding.

RUDD EQUIPMENT COMPANY

Company

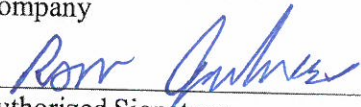
Authorized Signature

10/8/19
Date

NOTE: This addendum acknowledgment should be submitted with the bid to expedite document processing.



P
20
Street East
PC30
CR05-0130

State of West Virginia
Request for Quotation
13 - Equipment

Proc
Doc EEL DOUBLE DRUM VIBRATORY ROLLER (7020EC03)
Proc Master Agreement

Date Issued	Ss	Solicitation No	Version
2019-08-22	2	CRFQ 0803 DOT2000000026	1

BID RECEIVING LOCATION
 BID CLERK
 DEPARTMENT OF
 PURCHASING DIVISION
 2019 WASHINGTON
 CHARLESTON
 WV 25305

ENDORSEMENT
 Vendor Name, Address Number:
 RUDD EQUIPMENT COMPANY
 PO BOX 6
 NITRO, WV

CONYER
 FEIN # 61-0445955
 DATE 10/8/19
 Conditions contained in this solicitation

ADDITIONAL INFORMATION:

THE STATE OF WEST VIRGINIA PURCHASING DIVISION FOR THE AGENCY, WEST VIRGINIA DIVISION OF HIGHWAYS, IS SOLICITING BIDS TO ESTABLISH AN OPEN-END CONTRACT FOR STEEL DOUBLE DRUM VIBRATORY ROLLER PER THE ATTACHED DOCUMENTS. QUESTIONS REGARDING THE SOLICITATION MUST BE SUBMITTED IN WRITING TO CRYSTAL.G.HUSTEAD@WV.GOV PRIOR TO THE QUESTION PERIOD DEADLINE CONTAINED IN THE INSTRUCTIONS TO VENDORS SUBMITTING BIDS.

INVOICE TO	SHIP TO
DIVISION OF HIGHWAYS EQUIPMENT DIVISION RT 33 83 BRUSHY ROAD CROSSING, PO BOX 610 BUCKHANNON WV26201 US	DIVISION OF HIGHWAYS EQUIPMENT DIVISION 83 BRUSHY FORK RD CROSSING BUCKHANNON WV 26201 US

Line	Comm Ln Desc	Qty	Unit Issue	Unit Price	Total Price
1	CLASS 592 STEEL DOUBLE DRUM VIBRATORY ROLLER	15.00000	EA	\$103,341	\$1,550,115

Comm Code	Manufacturer	Specification	Model #
22101505	VOLVO	ROLLER	DD105

Extended Description :

CLASS 592 STEEL DOUBLE DRUM VIBRATORY ROLLER

SCHEDULE OF EVENTS

Line	Event	Event Date
1	MANDATORY PRE-BID MEETING	2019-09-12
2	VENDOR QUESTION DEADLINE	2019-09-23

DOT2000000026	Document Phase Final	Document Description STEEL DOUBLE DRUM VIBRATORY ROLLER (7020EC03)	Page 3 of 3
---------------	--------------------------------	---	------------------------------

ADDITIONAL TERMS AND CONDITIONS

See attached document(s) for additional Terms and Conditions

DESIGNATED CONTACT: Vendor appoints the individual identified in this Section as the Contract Administrator and the initial point of contact for matters relating to this Contract.

RON JACOBS, SALESMAN

(Name, Title)

(Printed Name and Title)
PO BOX 610, NITRO, WV 25143

(Address)
304-755-7788 304-755-7990

(Phone Number) / (Fax Number)
RJACOBS@RUDDEQUIPMENT.COM

(email address)

CERTIFICATION AND SIGNATURE: By signing below, or submitting documentation through wvOASIS, I certify that I have reviewed this Solicitation in its entirety; that I understand the requirements, terms and conditions, and other information contained herein; that this bid, offer or proposal constitutes an offer to the State that cannot be unilaterally withdrawn; that the product or service proposed meets the mandatory requirements contained in the Solicitation for that product or service, unless otherwise stated herein; that the Vendor accepts the terms and conditions contained in the Solicitation, unless otherwise stated herein; that I am submitting this bid, offer or proposal for review and consideration; that I am authorized by the vendor to execute and submit this bid, offer, or proposal, or any documents related thereto on vendor's behalf; that I am authorized to bind the vendor in a contractual relationship; and that to the best of my knowledge, the vendor has properly registered with any State agency that may require registration.

Rudd Equipment Company

(Company)

Ron Jacobs - salesman

(Authorized Signature) (Representative Name, Title)

Ron Jacobs Salesman

(Printed Name and Title of Authorized Representative)

10/8/19

(Date)

304-755-7788 304-755-7990

(Phone Number) (Fax Number)

STATE OF WEST VIRGINIA
Purchasing Division

PURCHASING AFFIDAVIT

CONSTRUCTION CONTRACTS: Under W. Va. Code § 5-22-1(i), the contracting public entity shall not award a construction contract to any bidder that is known to be in default on any monetary obligation owed to the state or a political subdivision of the state, including, but not limited to, obligations related to payroll taxes, property taxes, sales and use taxes, fire service fees, or other fines or fees.

ALL CONTRACTS: Under W. Va. Code §5A-3-10a, no contract or renewal of any contract may be awarded by the state or any of its political subdivisions to any vendor or prospective vendor when the vendor or prospective vendor or a related party to the vendor or prospective vendor is a debtor and: (1) the debt owed is an amount greater than one thousand dollars in the aggregate; or (2) the debtor is in employer default.

EXCEPTION: The prohibition listed above does not apply where a vendor has contested any tax administered pursuant to chapter eleven of the W. Va. Code, workers' compensation premium, permit fee or environmental fee or assessment and the matter has not become final or where the vendor has entered into a payment plan or agreement and the vendor is not in default of any of the provisions of such plan or agreement.

DEFINITIONS:

"Debt" means any assessment, premium, penalty, fine, tax or other amount of money owed to the state or any of its political subdivisions because of a judgment, fine, permit violation, license assessment, defaulted workers' compensation premium, penalty or other assessment presently delinquent or due and required to be paid to the state or any of its political subdivisions, including any interest or additional penalties accrued thereon.

"Employer default" means having an outstanding balance or liability to the old fund or to the uninsured employers' fund or being in policy default, as defined in W. Va. Code § 23-2c-2, failure to maintain mandatory workers' compensation coverage, or failure to fully meet its obligations as a workers' compensation self-insured employer. An employer is not in employer default if it has entered into a repayment agreement with the Insurance Commissioner and remains in compliance with the obligations under the repayment agreement.

"Related party" means a party, whether an individual, corporation, partnership, association, limited liability company or any other form or business association or other entity whatsoever, related to any vendor by blood, marriage, ownership or contract through which the party has a relationship of ownership or other interest with the vendor so that the party will actually or by effect receive or control a portion of the benefit, profit or other consideration from performance of a vendor contract with the party receiving an amount that meets or exceeds five percent of the total contract amount.

AFFIRMATION: By signing this form, the vendor's authorized signer affirms and acknowledges under penalty of law for false swearing (W. Va. Code §61-5-3) that: (1) for construction contracts, the vendor is not in default on any monetary obligation owed to the state or a political subdivision of the state, and (2) for all other contracts, that neither vendor nor any related party owe a debt as defined above and that neither vendor nor any related party are in employer default as defined above, unless the debt or employer default is permitted under the exception above.

WITNESS THE FOLLOWING SIGNATURE:

Vendor's Name: Rudd Equipment

Authorized Signature: Ron Fubaker Date: 10/8/19

State of West Virginia

County of Kanawha, to-wit:

Taken, subscribed, and sworn to before me this 8 day of October, 2019

My Commission expires March 10, 2021.

AFFIX SEAL HERE

NOTARY PUBLIC Joni Cummins

Purchasing Affidavit (Revised 01/19/2018)

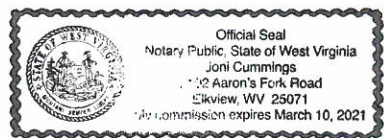

Volvo Construction Equipment

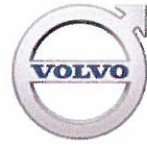

DD105, DD105_{osc}

Volvo Double Drum Compactors 9.9-10.5 t / 21,825-23,150 lb 114 hp



A passion for performance

At Volvo Construction Equipment, we're not just coming along for the ride. Developing products and services that raise productivity – we are confident we can lower costs and increase profits for customers around the globe. Part of the Volvo Group, we are passionate about innovative solutions to help you work smarter – not harder.

Helping you to do more

Doing more with less is a trademark of Volvo Construction Equipment. High productivity has long been married to low energy consumption, ease of use and durability. When it comes to lowering life-cycle costs, Volvo is in a class of its own.

Designed to fit your needs

There is a lot riding on creating solutions that are suited to the particular needs of different industry applications. Innovation often involves high technology – but it doesn't always have to. Some of our best ideas have been simple, based on a clear and deep understanding of our customers' working lives.



You learn a lot in 180 years

Over the years, Volvo has advanced solutions that have revolutionized the use of construction equipment. No other name speaks Safety louder than Volvo. Protecting operators, those around them and minimizing our environmental impact are traditional values that continue to shape our product design philosophy.

We're on your side

We back the Volvo brand with the best people. Volvo is truly a global enterprise, one that is on standby to support customers quickly and efficiently – wherever they are.

We have a passion for performance.

A strong, dedicated, capable dealer network

Our dealers are strategically located throughout North America to provide the equipment you need and the parts and service support you demand for a productive and profitable operation.

The strength of our dealer network is enhanced with extensive individualized product support training at our best-in-class Customer Center in Shippensburg and through hands-on training. Using a great Product Demonstration Center featuring a dedicated area for most common applications, visitors operate equipment from our entire product line under a variety of simulated working conditions. This facility is in year-round use by our dealers and customers.

Building the best starts right here.

The products designed and manufactured by Volvo Construction Equipment have their beginnings at the most advanced Research & Design centers in the industry. Volvo CE machines are designed in 11 R&D centers and produced in 15 manufacturing facilities across the world.

The major R&D center and manufacturing plant in the Americas is located in Shippensburg, Pennsylvania. This facility has been in operation for over 30 years and – with its recently added 200,000 sq. ft. expansion – now covers 570,000 sq. ft. on an 80 acre campus. Dedicated work teams and highly advanced technologies and techniques using the Volvo Production System ensure continuous quality improvements, labor savings and cost control to reach the high quality that our customers have come to expect from Volvo.

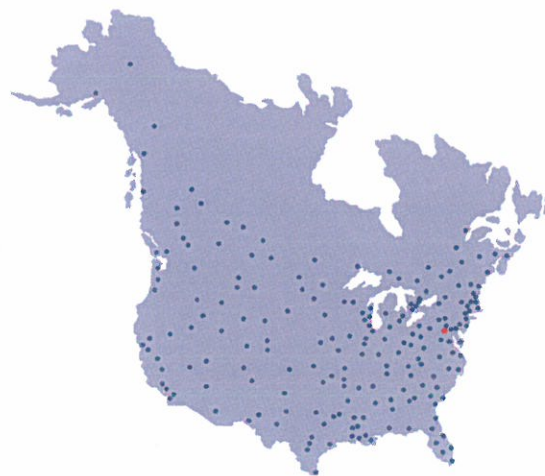



Volvo Trucks



Renault Trucks

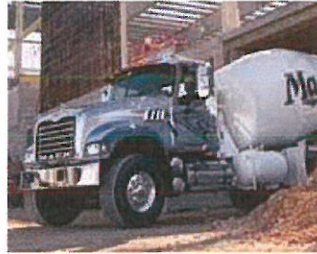

Mack Trucks



UD Trucks



Volvo Buses



Volvo Construction Equipment



Volvo Penta



Volvo Financial Services



MEET JOBSITE REQUIREMENTS

Compact in delicate environments, such as on bridges, over pipes and close to residential areas, with the DD105 OSC model variant. The oscillatory drum eliminates vertical vibrations for high performance and non-damaging oscillation movement.

Primed for performance

The industry-leading Volvo DD105 double drum compactor is primed with a range of features to ensure high-performance and efficient compaction. Unobstructed drum visibility combined with intelligent features help the operator achieve precise compaction with a smooth and consistent finish regardless of site conditions.

Unobstructed visibility

From the operator platform, the forward view and adjustable seat offer superb visibility of the jobsite, as well as unobstructed sightlines down to the drum and spray bars for maximum safety and rolling precision. Off-set steering enhances the view of curbs and obstructions for safe, efficient and high quality compaction.



Intelligent compaction

Unlock the full potential of your machine with Compact Assist, the optional Intelligent Compaction system from Volvo. For a more efficient and precise job, Compact Assist offers real-time insight into the work using pass mapping and temperature mapping. *Not applicable to DD105 OSC*

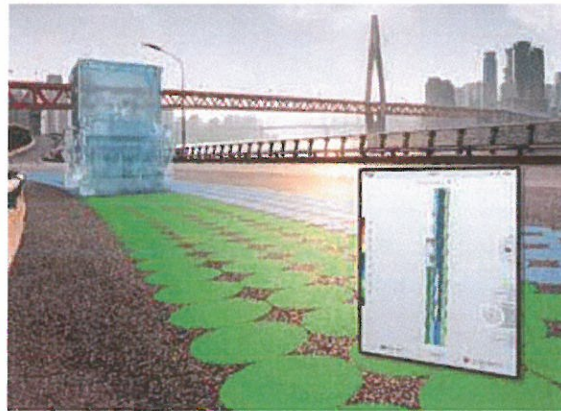

Comfortably productive

Whether you choose an enclosed cab or an open ROPS/FOPS canopy, both offer a comfortable, low-noise and productive operator environment. Benefit from all-around visibility, which can be improved further by sliding or rotating the adjustable seat. Keep an eye on the task at hand with easy-to-reach controls and maximum operator safety with well-positioned handrails.



Smooth, high quality finish

Operate more effectively with the drum vibration system, which offers multiple amplitudes for different applications, ensuring a high-quality performance every time. With ergonomically positioned controls and joystick, manoeuvrability is improved for the operator, who can rely on the Anti Slip Control (ASC) to easily load and unload the machine without damaging the road.



Secured productivity

The Volvo DD105 double drum compactor is exceptionally efficient and designed for ease of operation, even in the toughest operations. Powered by an advanced Tier 4 Final engine with productivity-enhancing ECO mode, high centrifugal force and auto-idling features built in, this compactor ensures high quality performance with minimal fuel consumption and emissions.

Productivity on tap

The industry-leading drum wetting system automatically provides consistent drum coverage and variable flow to prevent material pick-up for reduced downtime. Features use less water and include primary and backup pumps, spray bars, hand serviceable nozzles, triple filtrations and drum wipers.



Drive your costs down

Optimize efficiency, while minimizing operating costs with Volvo's Tier 4 Final engine. Equipped with the adaptive power system and intelligent features, power is delivered to the compactor only when it is needed. Decrease emissions with the auto-idling feature and reduce fuel consumption by up to 30% with ECO mode, optimizing productivity without impacting performance.



Machine monitoring made easy

With Volvo CareTrack, stay ahead of unscheduled downtime, maximize productivity and check that your machine is being operated efficiently. Remain informed, receive reports, alarms and information such as fuel status, machine location and hours so you can plan your service more efficiently.



Roll with the experts

With a rich heritage of engineering excellence, you can count on Volvo Construction Equipment to design durable machines, built to work harder and longer. As road experts, our mission is to keep your machines working at the optimum efficiency and productivity required for the job. We help protect your business and your profits from the ground up.





MORE WORK, FEWER PASSES

Achieve target density with the compactor's high centrifugal force, so you can do more work in fewer passes. Even in high altitudes, the compactor operates more effectively thanks to Volvo's drum vibration system.



EASY MAINTENANCE

Volvo's DD105 is designed to quickly and safely perform daily service and maintenance checks, and refill the water tank from ground level. For ease of maintenance, the swing-up hood provides complete access to the engine hood and hydraulic components. For added convenience, a single key can be used to access service hatches, while fuses and relays are grouped together, maximizing uptime.

Up your uptime

The DD105 compactor's impressive productivity is combined with excellent durability and simple service and maintenance requirements, ensuring optimal uptime. The compactor offers safe and easy maintenance access – taking the hassle out of daily service checks. Take advantage of our unique, local dealer support network to ensure your compactor achieves ultimate uptime, and generates maximum profit and growth for your business.

Durable by design

Built to work, the durable compactor is designed to withstand the harshest conditions using high quality components with detailed engineering in mind. The robust structure features protected components and intelligent hose routing to secure machine uptime and profitability to your business.

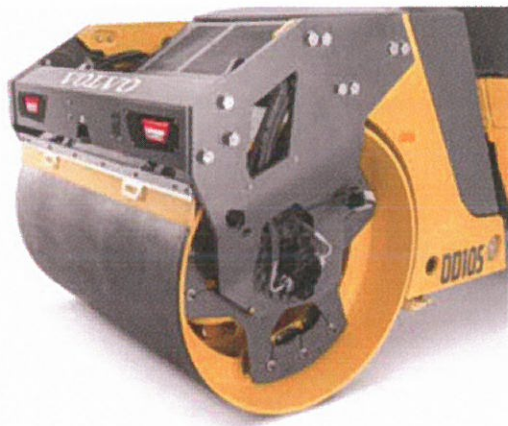

Retain Volvo quality

With Genuine Volvo Parts, you can be sure that your machine retains the renowned Volvo quality. Parts are extensively tested and approved because every part is vital for uptime and performance. This proven concept acts as a solid investment in your machine's future.



Here to support you

Volvo is here to support you whenever you need it. As a complete solutions provider, we listen to your requirements to ensure machine uptime and availability. With our extensive dealer coverage and trained technicians, Volvo has a comprehensive network to fully support you using local knowledge and experience.

Control service costs

We can help support the profitability of your operation with a range of Customer Support Agreements and solutions that offer preventive maintenance, total repairs and a number of uptime services. Volvo uses the latest technology to monitor machine operation and status, giving you advice to increase machine uptime.

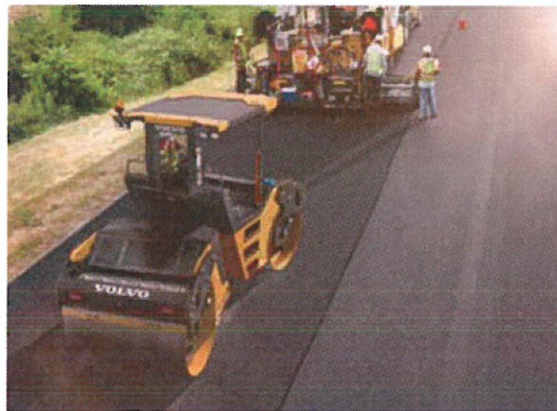

Superior compaction

Unobstructed visibility

The operator platform boasts all-around visibility, easy-to-reach controls and vibration and noise insulation.

MORE WORK, FEWER PASSES

Achieve target density with the high centrifugal force, so you can do more work in fewer passes.

Smooth, high quality finish

Ensure high quality performance with the drum vibration system and ergonomically positioned controls.

Machine monitoring made easy

Remotely monitor machine usage, productivity, fuel consumption and more with CareTrack, ensuring maximum uptime.

Drive your costs down

Maximize fuel efficiency with Volvo's adaptive power, ECO mode and auto-idle features without compromising performance.

Productivity on tap

Industry-leading, automatic drum wetting system provides uniform drum coverage to prevent material pick-up.





MEET JOBSITE REQUIREMENTS

Compact in delicate environments, such as on bridges, over pipes and close to residential areas, with the DD105 OSC model variant.

Comfortably productive

Enhance productivity and safety with all-around visibility, rotating seat, ergonomic controls and well-positioned handrails.

EASY MAINTENANCE

Optimize efficiency with the swing-up hood, providing easy and complete access to the engine and hydraulic components.

Intelligent compaction

Maintain consistency and track targets with the optional Compact Assist, offering pass mapping, temperature mapping, and Volvo's ground-breaking Density Direct feature.

Durable by design

Built with Volvo proven components, the DD105 can be relied on for longevity and sustained uptime.

Control service costs

Control costs with a wide variety of Customer Support Agreement solutions, offering preventative maintenance, total repairs and uptime services.

Specifications

Model	DD105						DD105 OSC			
	with open ROPS/FOPS canopy			with enclosed cab			with open ROPS/FOPS canopy		with enclosed cab	
Machine weights										
Operating weight (1)	kg	lb	10,000	22,051	10,075	22,217	9,851	21,718	9,926	21,883
Weight @ front drum	kg	lb	5,050	11,136	5,087	11,219	5,124	11,296	5,161	11,378
Weight @ rear drum	kg	lb	4,950	10,915	4,988	10,998	4,727	10,421	4,765	10,505
Shipping weight (2)	kg	lb	9,463	20,866	9,538	21,032	9,376	20,670	9,451	20,836
Drums										
Width	mm	in	1680	66.1	1,680	66.1	1,680	66.1	1,680	66.1
Diameter	mm	in	1,220	48.0	1,220	48.0	1,220	48.0	1,220	48.0
Shell thickness	mm	in	22	0.9	22	0.9	22	0.9	22	0.9
Finish	machined surface; chamfered and radiused edges									
Vibration										
Frequency	hz	vpm	40 / 50	2,400 / 3,000	40 / 50	2,400 / 3,000	39	2340	39	2340
Amplitude	mm	in	0.86 / 0.45	0.03 / 0.02	0.86 / 0.45	0.03 / 0.02	0.72 (tangential)	0.03 (tangential)	0.72 (tangential)	0.03 (tangential)
Centrifugal Force (low / high amplitude)	kN	lbf	112 / 99	25,179 / 22,256	112 / 99	25,179 / 22,256	-	-	-	-
Centrifugal Force (total/per eccentric)	kN	lbf	-	-	-	-	144 / 72	32,372 / 16,186	144 / 72	32,372 / 16,186
Propulsion										
Type	closed-loop hydrostatic, parallel circuit to both drums									
Drum drive	2-speed axial piston motors with planetary gear drive									
Travel speed	km/h	mph	5.2-11.4	3.2-7.1	5.2-11.4	3.2-7.1	5.2-11.4	3.2-7.1	5.2-11.4	3.2-7.1
Engine										
Make / model	Volvo D3.8, EPA Tier 4 final									
Engine type	4 Cyl, Electronic, Turbo charged CAC									
Rated power @ 2,600 r/min	kW	hp	85	114	85	114	85	114	85	114
Electrical	12 V DC, 130 A alternator, Starter 3 kW, Battery 1360 CCA (SAE)									
Brakes										
Service	Dynamic hydrostatic through propulsion system									
Parking secondary	Spring-applied, hydraulic release on both drum drives									
Water system										
Type	Pressure spray drum wetting system with central water tank									
Spray bars	Two spray bars per drum									
Nozzles	Hand-serviceable spray nozzles, 6 per spray bar									
Filtration	Filter baskets in fill necks, primary filter at each pump, fine filter for each nozzle									
Drum wipers	Front and rear urethane wipers for each drum									
Water tank capacity	l	gal	800	211.4	800	211.4	800	211.4	800	211.4
Miscellaneous										
Articulation angle	°		+ / - 35							
Oscillation angle	°		+ / - 7.5							
Inside turning radius (to drum edge)	mm	in	4,600	181	4,600	181	4,600	181	4,600	181
Fuel tank capacity	l	gal	175	46.2	175	46.2	175	46.2	175	46.2
DEF tank capacity	l	gal	20	5.3	20	5.3	20	5.3	20	5.3
Hydraulic oil capacity	l	gal	85	22.5	85	22.5	85	22.5	85	22.5
Gradeability (theoretical)	%		39.6	39.6	39.6	39.6	39.6	39.6	39.6	39.6
Sound Level										
Operator's Ear, acc. to ISO 6396	LpA dB(A)		77							
External, acc. to ISO 6395 (Directive 2000/14/EC)	LwA dB(A)		107							

(1) incl. 50% fuel, 50% water, 75 kg / 165 lb operator

(2) incl. 50% fuel, no water, no operator

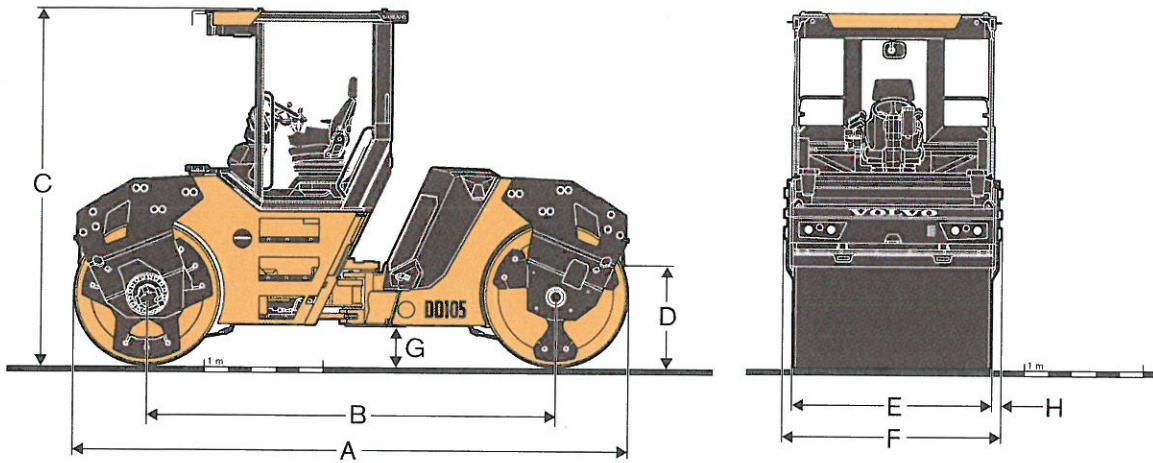

DIMENSIONS

	DD105 and DD105 OSC			
	with open ROPS/FOPS canopy		with enclosed cab	
	mm	in	mm	in
A	4,650	183.1	4,650	183.1
B	3,430	135	3,430	135
C	2,999	118.1	2,999	118.1
D	751	29.6	751	29.6
E	1,680	66.1	1,680	66.1
F	1,838	72.4	1,838	72.4
G	350	13.8	350	13.8
H	79	3.11	79	3.11

Equipment

STANDARD EQUIPMENT		
	DD105	DD105 OSC
Engine		
Eco Mode	•	•
Battery disconnect switch	•	•
V-belt protection	•	•
Operator environment		
Open ROPS/FOPS canopy	•	•
Operator seat, steering wheel and main controls: lateral sliding and rotating +/- 90°	•	•
Propulsion control lever	•	•
Adjustable steering wheel	•	•
2 charger sockets 12V	•	•
Storage compartments	•	•
Easy to clean anti slip cab floor	•	•
2 cup holders	•	•
Seat switch with timer delay	•	•
3" seat belt	•	•
Seat belt alarm	•	•
Interior light	•	•
Vibration and drum system		
Auto vibration	•	•
Selectable vibration: front, rear, both	•	•
Drum offset function to both sides	•	•
2 frequencies, 2 amplitudes	•	•
Electrics and electronics		
4 Halogen work lights in frame (2 each bumper)	•	•
Rotating Beacon	•	•
Permanent wetting system water level display	•	•
Permanent fuel level display	•	•
Information display:	•	•
Fluid temperatures	•	•
Engine speed	•	•
Vehicle speed	•	•
Asphalt temperature gauge kit	•	•
Impact meter	•	•
Trailer loading function	•	•
Emergency stop button	•	•
Back-up alarm	•	•
Water system		
Two spray bars per drum	•	•

OPTIONAL EQUIPMENT		
	DD105	DD105 OSC
Operator environment		
Enclosed cab with integrated ROPS/FOPS, tinted safety glass and openable side windows to the rear	•	•
Air conditioning system	•	•
Radio with Bluetooth, USB, MP3	•	•
Steering spinner knob	•	•
Vibration and drum system		
8 Amplitude Feature	-	•
Electrics and electronics		
4 or 8 Halogen work lights on canopy / cab	•	•
4 or 8 LED work lights on canopy / cab	•	•
4 LED work lights in frame (2 each bumper)	•	•
8 LED work lights in frame (4 each bumper)	•	•
4 work lights on drum edges: LED or Halogen	•	•
Road light kit (w/o work lights in frame)	•	•
Volvo Caretrack	•	•
Anti slip control	•	•
Anti theft	•	•
Tachograph preparation	•	•
Structure		
Special paintwork	•	•
Fluids		
Biodegradable hydraulic oil	•	•

SELECTION OF VOLVO OPTIONAL EQUIPMENT

Enclosed cab



Anti Slip Control



Multiple working light packages



Temperature gauge kit

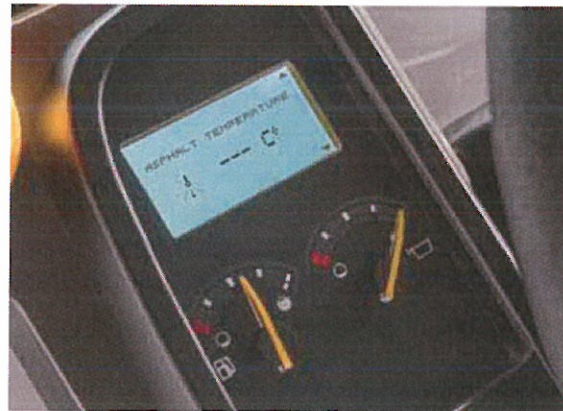

Impact meter



Selection of drums



Not all products are available in all markets. Under our policy of continuous improvement, we reserve the right to change specifications and design without prior notice. The illustrations do not necessarily show the standard version of the machine.

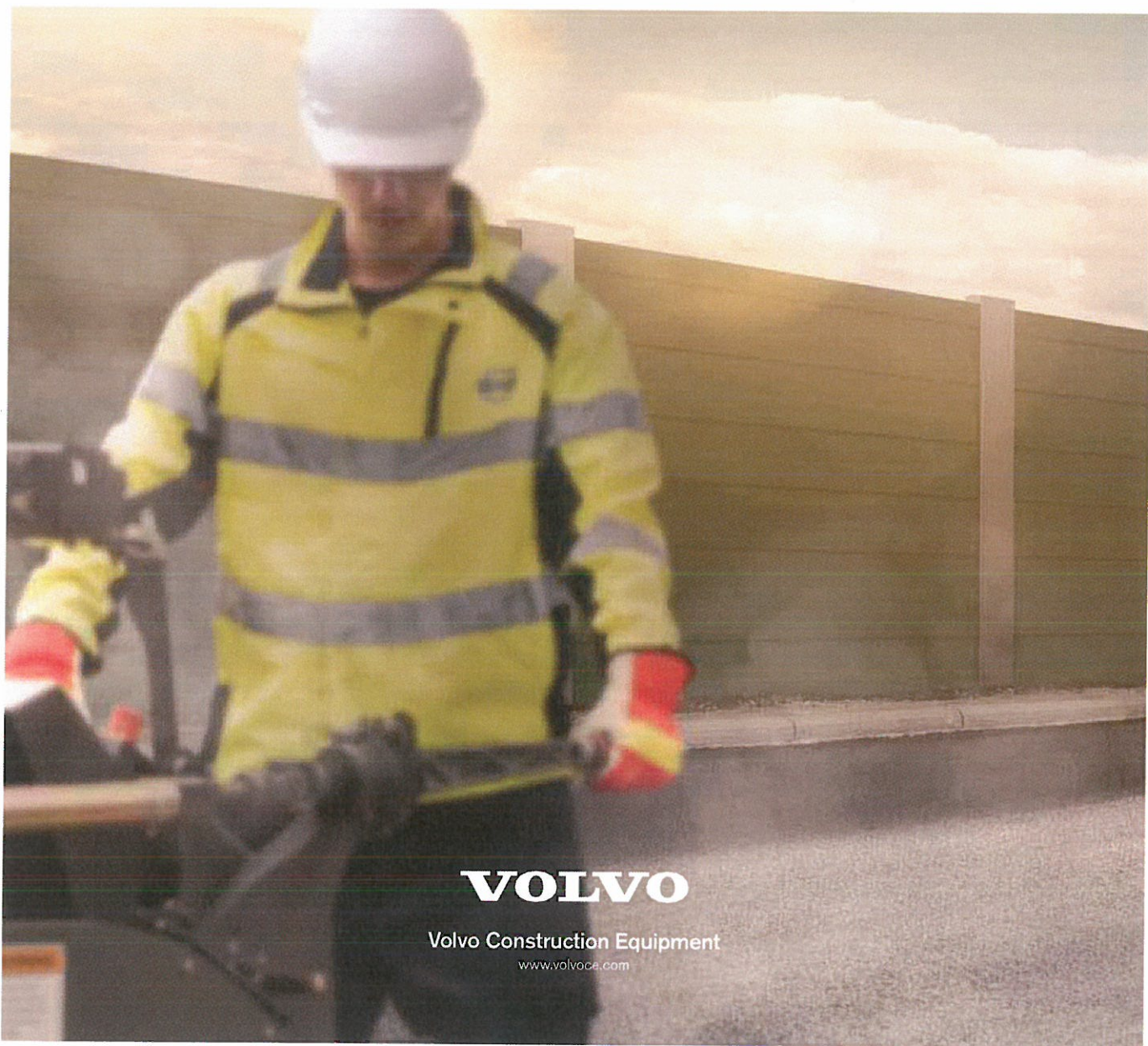

VOLVO

Volvo Construction Equipment

www.volvoce.com