



Purchasing Division  
 2019 Washington Street East  
 Post Office Box 50130  
 Charleston, WV 25305-0130

State of West Virginia  
 Request for Quotation

Proc Folder: 87113

Doc Description: Wildlife Resources - Misc. Equipment Purchase-One Time

Proc Type: Central Purchase Order

Date Issued	Solicitation Closes	Solicitation No	Version
2015-04-15	2015-05-12 13:30:00	CRFQ 0310 DNR1500000047	1

**BID RECEIVING LOCATION**

BID CLERK  
 DEPARTMENT OF ADMINISTRATION  
 PURCHASING DIVISION  
 2019 WASHINGTON ST E  
 CHARLESTON WV 25305  
 US

**VENDOR**

Vendor Name, Address and Telephone Number:

FAIRPLAIN TRACTOR SALES, INC.  
 1169 RIPLEY ROAD  
 RIPLEY, WV 25271  
 304-372-9875

05/12/15 10:21:45  
 WV Purchasing Division

**FOR INFORMATION CONTACT THE BUYER**

Laura E Hooper  
 (304) 558-0468  
 laura.e.hooper@wv.gov

Signature X

*Cornell A Fisher*

FEIN # 55-0540441

DATE 5/7/2015

All offers subject to all terms and conditions contained in this solicitation

INVOICE TO		SHIP TO	
DIVISION OF NATURAL RESOURCES WILDLIFE RESOURCES SECTION 324 4TH AVE SOUTH CHARLESTON WV25303 US		STATE OF WEST VIRGINIA VARIOUS LOCATIONS AS INDICATED BY ORDER No City WV 99999 US	

Line	Comm Ln Desc	Qty	Unit Issue	Unit Price	Total Price
1	Sprayer	1.00000	EA	\$4328.00	\$4328.00

Comm Code	Manufacturer	Specification	Model #
21101801	DEMCO	200 GAL SPRAYER 40' HOSE HAND GUN	

**Extended Description :**

175-200 gallon, three point sprayer, Ag Spray model RM200BXT43L or equal. Must be new (2014-2015 model year).

INVOICE TO		SHIP TO	
DIVISION OF NATURAL RESOURCES WILDLIFE RESOURCES SECTION 324 4TH AVE SOUTH CHARLESTON WV25303 US		STATE OF WEST VIRGINIA VARIOUS LOCATIONS AS INDICATED BY ORDER No City WV 99999 US	

Line	Comm Ln Desc	Qty	Unit Issue	Unit Price	Total Price
2	Sprayer	1.00000	EA	\$4328.00	\$4328.00

Comm Code	Manufacturer	Specification	Model #
21101801	DEMCO	200 GAL SPRAYER 40' HOSE HAND GUN	

**Extended Description :**

175-200 gallon, three point sprayer, Ag Spray model RM200BXT43L or equal. Must be new (2014-2015 model year)

INVOICE TO		SHIP TO	
DIVISION OF NATURAL RESOURCES WILDLIFE RESOURCES SECTION 324 4TH AVE SOUTH CHARLESTON WV25303 US		STATE OF WEST VIRGINIA VARIOUS LOCATIONS AS INDICATED BY ORDER No City WV 99999 US	

Line	Comm Ln Desc	Qty	Unit Issue	Unit Price	Total Price
3	Rotary Cutter	1.00000	EA	\$4285.00	\$4285.00

Comm Code	Manufacturer	Specification	Model #
27112037	LAND PRIDE	BUSH HOG 6 FOOT HD	RCF 3672

**Extended Description :**

6' heavy duty rotary cutter. John Deere Model 609 or equal. Must be new (2014-2015 model year).

INVOICE TO		SHIP TO	
DIVISION OF NATURAL RESOURCES WILDLIFE RESOURCES SECTION 324 4TH AVE SOUTH CHARLESTON WV25303 US		STATE OF WEST VIRGINIA VARIOUS LOCATIONS AS INDICATED BY ORDER No City WV 99999 US	

Line	Comm Ln Desc	Qty	Unit Issue	Unit Price	Total Price
4	Rotary Cutter	1.00000	EA	\$4285.00	\$4285.00

Comm Code	Manufacturer	Specification	Model #
27112037	LAND PRIDE	BUSH HOG 6 FOOT HD	RCF 3672

**Extended Description :**

6' heavy duty rotary cutter. John Deere Model 609 or equal. Must be new (2014-2015 model year).

INVOICE TO		SHIP TO	
DIVISION OF NATURAL RESOURCES WILDLIFE RESOURCES SECTION 324 4TH AVE SOUTH CHARLESTON WV25303 US		STATE OF WEST VIRGINIA VARIOUS LOCATIONS AS INDICATED BY ORDER No City WV 99999 US	

Line	Comm Ln Desc	Qty	Unit Issue	Unit Price	Total Price
5	Sprayer	1.00000	EA	\$2875.00	\$2875.00

Comm Code	Manufacturer	Specification	Model #
21101801	DEMCO	110 GAL SPRAYER 3.5 GAS ENGINE 100' HOSE HAND GUN	

**Extended Description :**

110-gallon, three point sprayer. Must be new (2014-2015 model year).

INVOICE TO		SHIP TO	
DIVISION OF NATURAL RESOURCES WILDLIFE RESOURCES SECTION 324 4TH AVE  SOUTH CHARLESTON                      WV25303  US		STATE OF WEST VIRGINIA VARIOUS LOCATIONS AS INDICATED BY ORDER  No City    WV 99999  US	

Line	Comm Ln Desc	Qty	Unit Issue	Unit Price	Total Price
6	No-till Seed Drill	1.00000	EA	\$25,800.00	\$25,800.00

Comm Code	Manufacturer	Specification	Model #
21101604	LAND PRIDE    GREAT PLAINS	NO-TILL DRILL	706 NT PULL TYPE

**Extended Description :**  
 Great Plains Model 706NT No-Till Seed Drill or equal. Must be new (2014-2015 model year).

INVOICE TO		SHIP TO	
DIVISION OF NATURAL RESOURCES WILDLIFE RESOURCES SECTION 324 4TH AVE  SOUTH CHARLESTON                      WV25303  US		STATE OF WEST VIRGINIA VARIOUS LOCATIONS AS INDICATED BY ORDER  No City    WV 99999  US	

Line	Comm Ln Desc	Qty	Unit Issue	Unit Price	Total Price
7	Disc Harrow	1.00000	EA	\$5975.00	\$5975.00

Comm Code	Manufacturer	Specification	Model #
21101502	TUFLINE	DISC	TW 72422

**Extended Description :**  
 Disc harrow, Frontier DH1508 or equal. Must be new (2014 or 2015 model year).

INVOICE TO		SHIP TO	
DIVISION OF NATURAL RESOURCES WILDLIFE RESOURCES SECTION 324 4TH AVE  SOUTH CHARLESTON                      WV25303  US		STATE OF WEST VIRGINIA VARIOUS LOCATIONS AS INDICATED BY ORDER  No City    WV 99999  US	

Line	Comm Ln Desc	Qty	Unit Issue	Unit Price	Total Price
8	Sprayer	1.00000	EA	\$4328.00	\$4328.00



Comm Code	Manufacturer	Specification	Model #
21101801	DEMCO	200 GAL SPRAYER 25 FOOT HOSE HAND GUN	

**Extended Description :**

175-200 gallon, three point sprayer, Ag Spray model RM200BXT43L or equal. Must be new (2014-2015 model year).

INVOICE TO		SHIP TO	
DIVISION OF NATURAL RESOURCES WILDLIFE RESOURCES SECTION 324 4TH AVE SOUTH CHARLESTON WV25303 US		STATE OF WEST VIRGINIA VARIOUS LOCATIONS AS INDICATED BY ORDER No City WV 99999 US	

Line	Comm Ln Desc	Qty	Unit Issue	Unit Price	Total Price
9	Disc Harrow	1.00000	EA	\$5975.00	\$5975.00

Comm Code	Manufacturer	Specification	Model #
21101502	TUFLINE	DISC 8 FOOT PULL TYPE	TW 72422

**Extended Description :**

Disc harrow, Tuflin Model TL43-91620 or equal. Must be new (2014 or 2015 model year).

INVOICE TO		SHIP TO	
DIVISION OF NATURAL RESOURCES WILDLIFE RESOURCES SECTION 324 4TH AVE SOUTH CHARLESTON WV25303 US		STATE OF WEST VIRGINIA VARIOUS LOCATIONS AS INDICATED BY ORDER No City WV 99999 US	

Line	Comm Ln Desc	Qty	Unit Issue	Unit Price	Total Price
10	UTV Skid-type Sprayer	1.00000	EA	\$2995.00	\$2995.00

Comm Code	Manufacturer	Specification	Model #
21101801	DEMCO	110 GAL SPRAYER 3.5 GAS ENGINE 100' HOSE	RM SERIES

**Extended Description :**

Must be designed to fit a Polaris Ranger UTV. F/S Manufacturing Inc., Model Boomlessypro or equal. Must be new (2014 or 2015 model year).

INVOICE TO		SHIP TO	
DIVISION OF NATURAL RESOURCES WILDLIFE RESOURCES SECTION 324 4TH AVE  SOUTH CHARLESTON WV25303  US		STATE OF WEST VIRGINIA VARIOUS LOCATIONS AS INDICATED BY ORDER  No City WV 99999  US	

Line	Comm Ln Desc	Qty	Unit Issue	Unit Price	Total Price
11	Offset Disk	1.00000	EA	\$9150.00	\$9150.00

Comm Code	Manufacturer	Specification	Model #
27112838	TUFLINE	OFFSET DISC	38-101824SF

**Extended Description :**

Heavy duty offset disc, Tufline Model 38/101824 or equal. Must be new (2014 or 2015 model year).

INVOICE TO		SHIP TO	
DIVISION OF NATURAL RESOURCES WILDLIFE RESOURCES SECTION 324 4TH AVE  SOUTH CHARLESTON WV25303  US		STATE OF WEST VIRGINIA VARIOUS LOCATIONS AS INDICATED BY ORDER  No City WV 99999  US	

Line	Comm Ln Desc	Qty	Unit Issue	Unit Price	Total Price
12	Offset Disk	1.00000	EA	\$9150.00	\$9150.00

Comm Code	Manufacturer	Specification	Model #
27112838	TUFLINE	OFFSET DISC	38-101824SF

**Extended Description :**

Heavy duty offset disc, Tufline Model 38/101824 or equal. Must be new (2014 or 2015 model year).

INVOICE TO		SHIP TO	
DIVISION OF NATURAL RESOURCES WILDLIFE RESOURCES SECTION 324 4TH AVE  SOUTH CHARLESTON WV25303  US		STATE OF WEST VIRGINIA VARIOUS LOCATIONS AS INDICATED BY ORDER  No City WV 99999  US	

Line	Comm Ln Desc	Qty	Unit Issue	Unit Price	Total Price
13	No-till Seed Drill	1.00000	EA	\$15,611.00	\$15,611.00

Comm Code	Manufacturer	Specification	Model #
21101604	LAND PRIDE GREAT PLAINS	NO-TILL DRILL	3P606NT

**Extended Description :**

Great Plains Model 706NT No-Till Seed Drill or equal. Must be new (2014-2015 model year).

INVOICE TO	SHIP TO
DIVISION OF NATURAL RESOURCES WILDLIFE RESOURCES SECTION 324 4TH AVE SOUTH CHARLESTON WV25303 US	STATE OF WEST VIRGINIA VARIOUS LOCATIONS AS INDICATED BY ORDER No City WV 99999 US

Line	Comm Ln Desc	Qty	Unit Issue	Unit Price	Total Price
14	Sprayer	1.00000	EA	\$4238.00	\$4238.00

Comm Code	Manufacturer	Specification	Model #
21101801	DEMCO	200 GAL 40' BOOM 8 ROLLER PUMP HANDGUN 25' HOSE	

**Extended Description :**

175-200 gallon, three point sprayer, Ag Spray model RM200BXT43L or equal. Must be new (2014-2015 model year).

INVOICE TO	SHIP TO
DIVISION OF NATURAL RESOURCES WILDLIFE RESOURCES SECTION 324 4TH AVE SOUTH CHARLESTON WV25303 US	STATE OF WEST VIRGINIA VARIOUS LOCATIONS AS INDICATED BY ORDER No City WV 99999 US

Line	Comm Ln Desc	Qty	Unit Issue	Unit Price	Total Price
15	Sprayer	1.00000	EA	\$4238.00	\$4238.00

Comm Code	Manufacturer	Specification	Model #
21101801	DEMCO	200 GAL 40' BOOM 8 ROLLER PUMP HANDGUN 25' HOSE	

**Extended Description :**

175-200 gallon, three point sprayer, Ag Spray model RM200BXT43L or equal. Must be new (2014-2015 model year).

<b>DNR150000047</b>	<b>Document Phase</b> Final	<b>Document Description</b> Wildlife Resources - Misc. Equipment Purchase-One Time	<b>Page 8</b> <b>of 8</b>
---------------------	--------------------------------	--	------------------------------

**ADDITIONAL TERMS AND CONDITIONS**

See attached document(s) for additional Terms and Conditions

## INSTRUCTIONS TO VENDORS SUBMITTING BIDS

1. **REVIEW DOCUMENTS THOROUGHLY:** The attached documents contain a solicitation for bids. Please read these instructions and all documents attached in their entirety. These instructions provide critical information about requirements that if overlooked could lead to disqualification of a Vendor's bid. All bids must be submitted in accordance with the provisions contained in these instructions and the Solicitation. Failure to do so may result in disqualification of Vendor's bid.
2. **MANDATORY TERMS:** The Solicitation may contain mandatory provisions identified by the use of the words "must," "will," and "shall." Failure to comply with a mandatory term in the Solicitation will result in bid disqualification.
3. **PREBID MEETING:** The item identified below shall apply to this Solicitation.

A pre-bid meeting will not be held prior to bid opening.

A NON-MANDATORY PRE-BID meeting will be held at the following place and time:

[ ] A MANDATORY PRE-BID meeting will be held at the following place and time:

All Vendors submitting a bid must attend the mandatory pre-bid meeting. Failure to attend the mandatory pre-bid meeting shall result in disqualification of the Vendor's bid. No one person attending the pre-bid meeting may represent more than one Vendor.

An attendance sheet provided at the pre-bid meeting shall serve as the official document verifying attendance. The State will not accept any other form of proof or documentation to verify attendance. Any person attending the pre-bid meeting on behalf of a Vendor must list on the attendance sheet his or her name and the name of the Vendor he or she is representing. Additionally, the person attending the pre-bid meeting should include the Vendor's E-Mail address, phone number, and Fax number on the attendance sheet. It is the Vendor's responsibility to locate the attendance sheet and provide the required information. Failure to complete the attendance sheet as required may result in disqualification of Vendor's bid.

All Vendors should arrive prior to the starting time for the pre-bid. Vendors who arrive after the starting time but prior to the end of the pre-bid will be permitted to sign in, but are charged with knowing all matters discussed at the pre-bid.

Questions submitted at least five business days prior to a scheduled pre-bid will be discussed at the pre-bid meeting if possible. Any discussions or answers to questions at the pre-bid meeting are preliminary in nature and are non-binding. Official and binding answers to questions will be published in a written addendum to the Solicitation prior to bid opening.

4. **VENDOR QUESTION DEADLINE:** Vendors may submit questions relating to this Solicitation to the Purchasing Division. Questions must be submitted in writing. All questions must be submitted on or before the date listed below and to the address listed below in order to be considered. A written response will be published in a Solicitation addendum if a response is possible and appropriate. Non-written discussions, conversations, or questions and answers regarding this Solicitation are preliminary in nature and are non-binding. Submitted e-mails should have solicitation number in the subject line.

Question Submission Deadline: 04/29/2015 5:00PM

Submit Questions to: Laura Hooper, Buyer  
2019 Washington Street, East  
Charleston, WV 25305  
Fax: (304) 558-4115 (Vendors should not use this fax number for bid submission)  
Email: [Laura.E.Hooper@wv.gov](mailto:Laura.E.Hooper@wv.gov)

5. **VERBAL COMMUNICATION:** Any verbal communication between the Vendor and any State personnel is not binding, including verbal communication at the mandatory pre-bid conference. Only information issued in writing and added to the Solicitation by an official written addendum by the Purchasing Division is binding.
6. **BID SUBMISSION:** All bids must be submitted electronically through wvOASIS or signed and delivered by the Vendor to the Purchasing Division at the address listed below on or before the date and time of the bid opening. Any bid received by the Purchasing Division staff is considered to be in the possession of the Purchasing Division and will not be returned for any reason. The Purchasing Division will not accept bids, modification of bids, or addendum acknowledgment forms via e-mail. Acceptable delivery methods include electronic submission via wvOASIS, hand delivery, delivery by courier, or facsimile. The bid delivery address is:

Department of Administration, Purchasing Division  
2019 Washington Street East  
Charleston, WV 25305-0130

A bid that is not submitted electronically through wvOASIS should contain the information listed below on the face of the envelope or the bid may be rejected by the Purchasing Division.:

SEALED BID:  
BUYER:  
SOLICITATION NO.:  
BID OPENING DATE:  
BID OPENING TIME:  
FAX NUMBER:

In the event that Vendor is responding to a request for proposal, and chooses to respond in a manner other than by electronic submission through wvOASIS, the Vendor shall submit one original technical and one original cost proposal plus N/A convenience copies of each to the Purchasing Division at the address shown above. Additionally, if Vendor does not submit its bid through wvOASIS, the Vendor should identify the bid type as either a technical or cost proposal on the face of each bid envelope submitted in response to a request for proposal as follows:

BID TYPE: (This only applies to CRFP)

Technical

Cost

- BID OPENING:** Bids submitted in response to this Solicitation will be opened at the location identified below on the date and time listed below. Delivery of a bid after the bid opening date and time will result in bid disqualification. For purposes of this Solicitation, a bid is considered delivered when confirmation of delivery is provided by wvOASIS (in the case of electronic submission) or when the bid is time stamped by the official Purchasing Division time clock (in the case of hand delivery).

05/12/2015 1:30PM

Bid Opening Date and Time:  
Bid Opening Location: Department of Administration, Purchasing Division  
2019 Washington Street East  
Charleston, WV 25305-0130

- ADDENDUM ACKNOWLEDGEMENT:** Changes or revisions to this Solicitation will be made by an official written addendum issued by the Purchasing Division. Vendor should acknowledge receipt of all addenda issued with this Solicitation by completing an Addendum Acknowledgment Form, a copy of which is included herewith. Failure to acknowledge addenda may result in bid disqualification. The addendum acknowledgement should be submitted with the bid to expedite document processing.

9. **BID FORMATTING:** Vendor should type or electronically enter the information onto its bid to prevent errors in the evaluation. Failure to type or electronically enter the information may result in bid disqualification.
10. **ALTERNATES:** Any model, brand, or specification listed in this Solicitation establishes the acceptable level of quality only and is not intended to reflect a preference for, or in any way favor, a particular brand or vendor. Vendors may bid alternates to a listed model or brand provided that the alternate is at least equal to the model or brand and complies with the required specifications. The equality of any alternate being bid shall be determined by the State at its sole discretion. Any Vendor bidding an alternate model or brand should clearly identify the alternate items in its bid and should include manufacturer's specifications, industry literature, and/or any other relevant documentation demonstrating the equality of the alternate items. Failure to provide information for alternate items may be grounds for rejection of a Vendor's bid.
11. **EXCEPTIONS AND CLARIFICATIONS:** The Solicitation contains the specifications that shall form the basis of a contractual agreement. Vendor shall clearly mark any exceptions, clarifications, or other proposed modifications in its bid. Exceptions to, clarifications of, or modifications of a requirement or term and condition of the Solicitation may result in bid disqualification.
12. **COMMUNICATION LIMITATIONS:** In accordance with West Virginia Code of State Rules §148-1-6.6, communication with the State of West Virginia or any of its employees regarding this Solicitation during the solicitation, bid, evaluation or award periods, except through the Purchasing Division, is strictly prohibited without prior Purchasing Division approval. Purchasing Division approval for such communication is implied for all agency delegated and exempt purchases.
13. **REGISTRATION:** Prior to Contract award, the apparent successful Vendor must be properly registered with the West Virginia Purchasing Division and must have paid the \$125 fee, if applicable.
14. **UNIT PRICE:** Unit prices shall prevail in cases of a discrepancy in the Vendor's bid.
15. **PREFERENCE:** Vendor Preference may only be granted upon written request and only in accordance with the West Virginia Code § 5A-3-37 and the West Virginia Code of State Rules. A Vendor Preference Certificate form has been attached hereto to allow Vendor to apply for the preference. Vendor's failure to submit the Vendor Preference Certificate form with its bid will result in denial of Vendor Preference. Vendor Preference does not apply to construction projects.
16. **SMALL, WOMEN-OWNED, OR MINORITY-OWNED BUSINESSES:** For any solicitations publicly advertised for bid, in accordance with West Virginia Code §5A-3-37(a)(7) and W. Va. CSR § 148-22-9, any non-resident vendor certified as a small, women-owned, or minority-owned business under W. Va. CSR § 148-22-9 shall be provided the



same preference made available to any resident vendor. Any non-resident small, women-owned, or minority-owned business must identify itself as such in writing, must submit that writing to the Purchasing Division with its bid, and must be properly certified under W. Va. CSR § 148-22-9 prior to contract award to receive the preferences made available to resident vendors. Preference for a non-resident small, women-owned, or minority owned business shall be applied in accordance with W. Va. CSR § 148-22-9.

**17. WAIVER OF MINOR IRREGULARITIES:** The Director reserves the right to waive minor irregularities in bids or specifications in accordance with West Virginia Code of State Rules § 148-1-4.6.

**18. ELECTRONIC FILE ACCESS RESTRICTIONS:** Vendor must ensure that its submission in wvOASIS can be accessed by the Purchasing Division staff immediately upon bid opening. The Purchasing Division will consider any file that cannot be immediately opened and/or viewed at the time of the bid opening (such as, encrypted files, password protected files, or incompatible files) to be blank or incomplete as context requires, and are therefore unacceptable. A vendor will not be permitted to unencrypt files, remove password protections, or resubmit documents after bid opening if those documents are required with the bid.

## GENERAL TERMS AND CONDITIONS:

1. **CONTRACTUAL AGREEMENT:** Issuance of a Award Document signed by the Purchasing Division Director, or his designee, and approved as to form by the Attorney General's office constitutes acceptance of this Contract made by and between the State of West Virginia and the Vendor. Vendor's signature on its bid signifies Vendor's agreement to be bound by and accept the terms and conditions contained in this Contract.
  
2. **DEFINITIONS:** As used in this Solicitation/Contract, the following terms shall have the meanings attributed to them below. Additional definitions may be found in the specifications included with this Solicitation/Contract.
  - 2.1. **"Agency" or "Agencies"** means the agency, board, commission, or other entity of the State of West Virginia that is identified on the first page of the Solicitation or any other public entity seeking to procure goods or services under this Contract.
  - 2.2. **"Contract"** means the binding agreement that is entered into between the State and the Vendor to provide the goods or services requested in the Solicitation.
  - 2.3. **"Director"** means the Director of the West Virginia Department of Administration, Purchasing Division.
  - 2.4. **"Purchasing Division"** means the West Virginia Department of Administration, Purchasing Division.
  - 2.5. **"Award Document"** means the document signed by the Agency and the Purchasing Division, and approved as to form by the Attorney General, that identifies the Vendor as the contract holder.
  - 2.6. **"Solicitation"** means the official notice of an opportunity to supply the State with goods or services that is published by the Purchasing Division.
  - 2.7. **"State"** means the State of West Virginia and/or any of its agencies, commissions, boards, etc. as context requires.
  - 2.8. **"Vendor" or "Vendors"** means any entity submitting a bid in response to the Solicitation, the entity that has been selected as the lowest responsible bidder, or the entity that has been awarded the Contract as context requires.

3. **CONTRACT TERM; RENEWAL; EXTENSION:** The term of this Contract shall be determined in accordance with the category that has been identified as applicable to this Contract below:

**Term Contract**

**Initial Contract Term:** This Contract becomes effective on \_\_\_\_\_ and extends for a period of \_\_\_\_\_ year(s).

**Renewal Term:** This Contract may be renewed upon the mutual written consent of the Agency, and the Vendor, with approval of the Purchasing Division and the Attorney General's office (Attorney General approval is as to form only). Any request for renewal should be submitted to the Purchasing Division thirty (30) days prior to the expiration date of the initial contract term or appropriate renewal term. A Contract renewal shall be in accordance with the terms and conditions of the original contract. Renewal of this Contract is limited to \_\_\_\_\_ successive one (1) year periods or multiple renewal periods of less than one year, provided that the multiple renewal periods do not exceed \_\_\_\_\_ months in total. Automatic renewal of this Contract is prohibited. Notwithstanding the foregoing, Purchasing Division approval is not required on agency delegated or exempt purchases. Attorney General approval may be required for vendor terms and conditions.

**Delivery Order Limitations:** In the event that this contract permits delivery orders, a delivery order may only be issued during the time this Contract is in effect. Any delivery order issued within one year of the expiration of this Contract shall be effective for one year from the date the delivery order is issued. No delivery order may be extended beyond one year after this Contract has expired.

**Fixed Period Contract:** This Contract becomes effective upon Vendor's receipt of the notice to proceed and must be completed within \_\_\_\_\_ days.

**Fixed Period Contract with Renewals:** This Contract becomes effective upon Vendor's receipt of the notice to proceed and part of the Contract more fully described in the attached specifications must be completed within \_\_\_\_\_ days. Upon completion, the vendor agrees that maintenance, monitoring, or warranty services will be provided for one year thereafter with an additional \_\_\_\_\_ successive one year renewal periods or multiple renewal periods of less than one year provided that the multiple renewal periods do not exceed \_\_\_\_\_ months in total. Automatic renewal of this Contract is prohibited.

**One Time Purchase:** The term of this Contract shall run from the issuance of the Award Document until all of the goods contracted for have been delivered, but in no event will this Contract extend for more than one fiscal year.

**Other:** See attached.

4. **NOTICE TO PROCEED:** Vendor shall begin performance of this Contract immediately upon receiving notice to proceed unless otherwise instructed by the Agency. Unless otherwise specified, the fully executed Award Document will be considered notice to proceed.
5. **QUANTITIES:** The quantities required under this Contract shall be determined in accordance with the category that has been identified as applicable to this Contract below.
- Open End Contract:** Quantities listed in this Solicitation are approximations only, based on estimates supplied by the Agency. It is understood and agreed that the Contract shall cover the quantities actually ordered for delivery during the term of the Contract, whether more or less than the quantities shown.
- Service:** The scope of the service to be provided will be more clearly defined in the specifications included herewith.
- Combined Service and Goods:** The scope of the service and deliverable goods to be provided will be more clearly defined in the specifications included herewith.
- One Time Purchase:** This Contract is for the purchase of a set quantity of goods that are identified in the specifications included herewith. Once those items have been delivered, no additional goods may be procured under this Contract without an appropriate change order approved by the Vendor, Agency, Purchasing Division, and Attorney General's office.
6. **PRICING:** The pricing set forth herein is firm for the life of the Contract, unless specified elsewhere within this Solicitation/Contract by the State. A Vendor's inclusion of price adjustment provisions in its bid, without an express authorization from the State in the Solicitation to do so, may result in bid disqualification.
7. **EMERGENCY PURCHASES:** The Purchasing Division Director may authorize the Agency to purchase goods or services in the open market that Vendor would otherwise provide under this Contract if those goods or services are for immediate or expedited delivery in an emergency. Emergencies shall include, but are not limited to, delays in transportation or an unanticipated increase in the volume of work. An emergency purchase in the open market, approved by the Purchasing Division Director, shall not constitute a breach of this Contract and shall not entitle the Vendor to any form of compensation or damages. This provision does not excuse the State from fulfilling its obligations under a One Time Purchase contract.
8. **REQUIRED DOCUMENTS:** All of the items checked below must be provided to the Purchasing Division by the Vendor as specified below.

**BID BOND:** All Vendors shall furnish a bid bond in the amount of five percent (5%) of the total amount of the bid protecting the State of West Virginia. The bid bond must be submitted with the bid.

**PERFORMANCE BOND:** The apparent successful Vendor shall provide a performance bond in the amount of \_\_\_\_\_. The performance bond must be received by the Purchasing Division prior to Contract award. On construction contracts, the performance bond must be 100% of the Contract value.

**LABOR/MATERIAL PAYMENT BOND:** The apparent successful Vendor shall provide a labor/material payment bond in the amount of 100% of the Contract value. The labor/material payment bond must be delivered to the Purchasing Division prior to Contract award.

In lieu of the Bid Bond, Performance Bond, and Labor/Material Payment Bond, the Vendor may provide certified checks, cashier's checks, or irrevocable letters of credit. Any certified check, cashier's check, or irrevocable letter of credit provided in lieu of a bond must be of the same amount and delivered on the same schedule as the bond it replaces. A letter of credit submitted in lieu of a performance and labor/material payment bond will only be allowed for projects under \$100,000. Personal or business checks are not acceptable.

**MAINTENANCE BOND:** The apparent successful Vendor shall provide a two (2) year maintenance bond covering the roofing system. The maintenance bond must be issued and delivered to the Purchasing Division prior to Contract award.

**INSURANCE:** The apparent successful Vendor shall furnish proof of the following insurance prior to Contract award and shall list the state as a certificate holder:

**Commercial General Liability Insurance:** In the amount of \_\_\_\_\_ or more.

**Builders Risk Insurance:** In an amount equal to 100% of the amount of the Contract.

The apparent successful Vendor shall also furnish proof of any additional insurance requirements contained in the specifications prior to Contract award regardless of whether or not that insurance requirement is listed above.

**LICENSE(S) / CERTIFICATIONS / PERMITS:** In addition to anything required under the Section entitled Licensing, of the General Terms and Conditions, the apparent successful Vendor shall furnish proof of the following licenses, certifications, and/or permits prior to Contract award, in a form acceptable to the Purchasing Division.

The apparent successful Vendor shall also furnish proof of any additional licenses or certifications contained in the specifications prior to Contract award regardless of whether or not that requirement is listed above.

**9. WORKERS' COMPENSATION INSURANCE:** The apparent successful Vendor shall comply with laws relating to workers compensation, shall maintain workers' compensation insurance when required, and shall furnish proof of workers' compensation insurance upon request.

**10. LITIGATION BOND:** The Director reserves the right to require any Vendor that files a protest of an award to submit a litigation bond in the amount equal to one percent of the lowest bid submitted or \$5,000, whichever is greater. The entire amount of the bond shall be forfeited if the hearing officer determines that the protest was filed for frivolous or improper purpose, including but not limited to, the purpose of harassing, causing unnecessary delay, or needless expense for the Agency. All litigation bonds shall be made payable to the Purchasing Division. In lieu of a bond, the protester may submit a cashier's check or certified check payable to the Purchasing Division. Cashier's or certified checks will be deposited with and held by the State Treasurer's office. If it is determined that the protest has not been filed for frivolous or improper purpose, the bond or deposit shall be returned in its entirety.

**11. LIQUIDATED DAMAGES:** Vendor shall pay liquidated damages in the amount of \_\_\_\_\_  
for \_\_\_\_\_.  
This clause shall in no way be considered exclusive and shall not limit the State or Agency's right to pursue any other available remedy.

- 12. ACCEPTANCE/REJECTION:** The State may accept or reject any bid in whole, or in part. Vendor's signature on its bid signifies acceptance of the terms and conditions contained in the Solicitation and Vendor agrees to be bound by the terms of the Contract, as reflected in the Award Document, upon receipt.
- 13. FUNDING:** This Contract shall continue for the term stated herein, contingent upon funds being appropriated by the Legislature or otherwise being made available. In the event funds are not appropriated or otherwise made available, this Contract becomes void and of no effect beginning on July 1 of the fiscal year for which funding has not been appropriated or otherwise made available.
- 14. PAYMENT:** Payment in advance is prohibited under this Contract. Payment may only be made after the delivery and acceptance of goods or services. The Vendor shall submit invoices, in arrears.
- 15. TAXES:** The Vendor shall pay any applicable sales, use, personal property or any other taxes arising out of this Contract and the transactions contemplated thereby. The State of West Virginia is exempt from federal and state taxes and will not pay or reimburse such taxes.
- 16. CANCELLATION:** The Purchasing Division Director reserves the right to cancel this Contract immediately upon written notice to the vendor if the materials or workmanship supplied do not conform to the specifications contained in the Contract. The Purchasing Division Director may also cancel any purchase or Contract upon 30 days written notice to the Vendor in accordance with West Virginia Code of State Rules § 148-1-7.16.2.
- 17. TIME:** Time is of the essence with regard to all matters of time and performance in this Contract.
- 18. APPLICABLE LAW:** This Contract is governed by and interpreted under West Virginia law without giving effect to its choice of law principles. Any information provided in specification manuals, or any other source, verbal or written, which contradicts or violates the West Virginia Constitution, West Virginia Code or West Virginia Code of State Rules is void and of no effect.
- 19. COMPLIANCE:** Vendor shall comply with all applicable federal, state, and local laws, regulations and ordinances. By submitting a bid, Vendor acknowledges that it has reviewed, understands, and will comply with all applicable law.
- 20. PREVAILING WAGE:** On any contract for the construction of a public improvement whose cost at the time the contract is awarded will be paid with public money in an amount greater than \$500,000. Vendor and any subcontractors utilized by Vendor shall pay a rate or rates of wages which shall not be less than the fair minimum rate or rates of wages (prevailing wage), as established under West Virginia Code §§ 21-5A-1 et seq. Vendor shall

be responsible for ensuring compliance with prevailing wage requirements and determining when prevailing wage requirements are applicable.

21. **ARBITRATION:** Any references made to arbitration contained in this Contract, Vendor's bid, or in any American Institute of Architects documents pertaining to this Contract are hereby deleted, void, and of no effect.
22. **MODIFICATIONS:** This writing is the parties' final expression of intent. Notwithstanding anything contained in this Contract to the contrary, no modification of this Contract shall be binding without mutual written consent of the Agency, and the Vendor, with approval of the Purchasing Division and the Attorney General's office (Attorney General approval is as to form only). No Change shall be implemented by the Vendor until such time as the Vendor receives an approved written change order from the Purchasing Division.
23. **WAIVER:** The failure of either party to insist upon a strict performance of any of the terms or provision of this Contract, or to exercise any option, right, or remedy herein contained, shall not be construed as a waiver or a relinquishment for the future of such term, provision, option, right, or remedy, but the same shall continue in full force and effect. Any waiver must be expressly stated in writing and signed by the waiving party.
24. **SUBSEQUENT FORMS:** The terms and conditions contained in this Contract shall supersede any and all subsequent terms and conditions which may appear on any form documents submitted by Vendor to the Agency or Purchasing Division such as price lists, order forms, invoices, sales agreements, or maintenance agreements, and includes internet websites or other electronic documents. Acceptance or use of Vendor's forms does not constitute acceptance of the terms and conditions contained thereon.
25. **ASSIGNMENT:** Neither this Contract nor any monies due, or to become due hereunder, may be assigned by the Vendor without the express written consent of the Agency, the Purchasing Division, the Attorney General's office (as to form only), and any other government agency or office that may be required to approve such assignments. Notwithstanding the foregoing, Purchasing Division approval may or may not be required on certain agency delegated or exempt purchases.
26. **WARRANTY:** The Vendor expressly warrants that the goods and/or services covered by this Contract will: (a) conform to the specifications, drawings, samples, or other description furnished or specified by the Agency; (b) be merchantable and fit for the purpose intended; and (c) be free from defect in material and workmanship.
27. **STATE EMPLOYEES:** State employees are not permitted to utilize this Contract for personal use and the Vendor is prohibited from permitting or facilitating the same.
28. **BANKRUPTCY:** In the event the Vendor files for bankruptcy protection, the State of West Virginia may deem this Contract null and void, and terminate this Contract without notice.



**29. CONFIDENTIALITY:** The Vendor agrees that it will not disclose to anyone, directly or indirectly, any such personally identifiable information or other confidential information gained from the Agency, unless the individual who is the subject of the information consents to the disclosure in writing or the disclosure is made pursuant to the Agency's policies, procedures, and rules. Vendor further agrees to comply with the Confidentiality Policies and Information Security Accountability Requirements, set forth in <http://www.state.wv.us/admin/purchase/privacy/default.html>.

**30. DISCLOSURE:** Vendor's response to the Solicitation and the resulting Contract are considered public documents and will be disclosed to the public in accordance with the laws, rules, and policies governing the West Virginia Purchasing Division. Those laws include, but are not limited to, the Freedom of Information Act found in West Virginia Code §§ 29B-1-1 et seq. and the competitive bidding laws found West Virginia Code §§ 5A-3-1 et seq., 5-22-1 et seq., and 5G-1-1 et seq.

If a Vendor considers any part of its bid to be exempt from public disclosure, Vendor must so indicate by specifically identifying the exempt information, identifying the exemption that applies, providing a detailed justification for the exemption, segregating the exempt information from the general bid information, and submitting the exempt information as part of its bid but in a segregated and clearly identifiable format. Failure to comply with the foregoing requirements will result in public disclosure of the Vendor's bid without further notice. A Vendor's act of marking all or nearly all of its bid as exempt is not sufficient to avoid disclosure and WILL NOT BE HONORED. Vendor's act of marking a bid or any part thereof as "confidential" or "proprietary" is not sufficient to avoid disclosure and WILL NOT BE HONORED. A legend or other statement indicating that all or substantially all of the bid is exempt from disclosure is not sufficient to avoid disclosure and WILL NOT BE HONORED. Additionally, pricing or cost information will not be considered exempt from disclosure and requests to withhold publication of pricing or cost information WILL NOT BE HONORED.

Vendor will be required to defend any claimed exemption for nondisclosure in the event of an administrative or judicial challenge to the State's nondisclosure. Vendor must indemnify the State for any costs incurred related to any exemptions claimed by Vendor. Any questions regarding the applicability of the various public records laws should be addressed to your own legal counsel prior to bid submission.

**31. LICENSING:** In accordance with West Virginia Code of State Rules §148-1-6.1.7, Vendor must be licensed and in good standing in accordance with any and all state and local laws and requirements by any state or local agency of West Virginia, including, but not limited to, the West Virginia Secretary of State's Office, the West Virginia Tax Department, West Virginia Insurance Commission, or any other state agency or political subdivision. Upon request, the Vendor must provide all necessary releases to obtain information to enable the Purchasing Division Director or the Agency to verify that the Vendor is licensed and in good standing with the above entities.

**32. ANTITRUST:** In submitting a bid to, signing a contract with, or accepting a Award Document from any agency of the State of West Virginia, the Vendor agrees to convey, sell, assign, or transfer to the State of West Virginia all rights, title, and interest in and to all causes of action it may now or hereafter acquire under the antitrust laws of the United States and the State of West Virginia for price fixing and/or unreasonable restraints of trade relating to the particular commodities or services purchased or acquired by the State of West Virginia. Such assignment shall be made and become effective at the time the purchasing agency tenders the initial payment to Vendor.

**33. VENDOR CERTIFICATIONS:** By signing its bid or entering into this Contract, Vendor certifies (1) that its bid or offer was made without prior understanding, agreement, or connection with any corporation, firm, limited liability company, partnership, person or entity submitting a bid or offer for the same material, supplies, equipment or services; (2) that its bid or offer is in all respects fair and without collusion or fraud; (3) that this Contract is accepted or entered into without any prior understanding, agreement, or connection to any other entity that could be considered a violation of law; and (4) that it has reviewed this Solicitation in its entirety; understands the requirements, terms and conditions, and other information contained herein. Vendor's signature on its bid or offer also affirms that neither it nor its representatives have any interest, nor shall acquire any interest, direct or indirect, which would compromise the performance of its services hereunder. Any such interests shall be promptly presented in detail to the Agency. The individual signing this bid or offer on behalf of Vendor certifies that he or she is authorized by the Vendor to execute this bid or offer or any documents related thereto on Vendor's behalf; that he or she is authorized to bind the Vendor in a contractual relationship; and that, to the best of his or her knowledge, the Vendor has properly registered with any State agency that may require registration.

**34. PURCHASING CARD ACCEPTANCE:** The State of West Virginia currently utilizes a Purchasing Card program, administered under contract by a banking institution, to process payment for goods and services. The Vendor must accept the State of West Virginia's Purchasing Card for payment of all orders under this Contract unless the box below is checked.

Vendor is not required to accept the State of West Virginia's Purchasing Card as payment for all goods and services.

**35. VENDOR RELATIONSHIP:** The relationship of the Vendor to the State shall be that of an independent contractor and no principal-agent relationship or employer-employee relationship is contemplated or created by this Contract. The Vendor as an independent contractor is solely liable for the acts and omissions of its employees and agents. Vendor shall be responsible for selecting, supervising, and compensating any and all individuals employed pursuant to the terms of this Solicitation and resulting contract. Neither the Vendor, nor any employees or subcontractors of the Vendor, shall be deemed to be employees of the State for any purpose whatsoever. Vendor shall be exclusively responsible for payment of employees and contractors for all wages and salaries, taxes, withholding payments, penalties, fees, fringe benefits, professional liability insurance premiums, contributions to insurance and pension, or other deferred compensation plans, including but

not limited to, Workers' Compensation and Social Security obligations, licensing fees, etc. and the filing of all necessary documents, forms, and returns pertinent to all of the foregoing. Vendor shall hold harmless the State, and shall provide the State and Agency with a defense against any and all claims including, but not limited to, the foregoing payments, withholdings, contributions, taxes, Social Security taxes, and employer income tax returns.

- 36. INDEMNIFICATION:** The Vendor agrees to indemnify, defend, and hold harmless the State and the Agency, their officers, and employees from and against: (1) Any claims or losses for services rendered by any subcontractor, person, or firm performing or supplying services, materials, or supplies in connection with the performance of the Contract; (2) Any claims or losses resulting to any person or entity injured or damaged by the Vendor, its officers, employees, or subcontractors by the publication, translation, reproduction, delivery, performance, use, or disposition of any data used under the Contract in a manner not authorized by the Contract, or by Federal or State statutes or regulations; and (3) Any failure of the Vendor, its officers, employees, or subcontractors to observe State and Federal laws including, but not limited to, labor and wage and hour laws.
- 37. PURCHASING AFFIDAVIT:** In accordance with West Virginia Code § 5A-3-10a, all Vendors are required to sign, notarize, and submit the Purchasing Affidavit stating that neither the Vendor nor a related party owe a debt to the State in excess of \$1,000. The affidavit must be submitted prior to award, but should be submitted with the Vendor's bid. A copy of the Purchasing Affidavit is included herewith.
- 38. ADDITIONAL AGENCY AND LOCAL GOVERNMENT USE:** This Contract may be utilized by and extends to other agencies, spending units, and political subdivisions of the State of West Virginia; county, municipal, and other local government bodies; and school districts ("Other Government Entities"). This Contract shall be extended to the aforementioned Other Government Entities on the same prices, terms, and conditions as those offered and agreed to in this Contract. If the Vendor does not wish to extend the prices, terms, and conditions of its bid and subsequent contract to the Other Government Entities, the Vendor must clearly indicate such refusal in its bid. A refusal to extend this Contract to the Other Government Entities shall not impact or influence the award of this Contract in any manner.
- 39. CONFLICT OF INTEREST:** Vendor, its officers or members or employees, shall not presently have or acquire an interest, direct or indirect, which would conflict with or compromise the performance of its obligations hereunder. Vendor shall periodically inquire of its officers, members and employees to ensure that a conflict of interest does not arise. Any conflict of interest discovered shall be promptly presented in detail to the Agency.
- 40. REPORTS:** Vendor shall provide the Agency and/or the Purchasing Division with the following reports identified by a checked box below:
- Such reports as the Agency and/or the Purchasing Division may request. Requested reports may include, but are not limited to, quantities purchased, agencies utilizing the contract, total contract expenditures by agency, etc.

- Quarterly reports detailing the total quantity of purchases in units and dollars, along with a listing of purchases by agency. Quarterly reports should be delivered to the Purchasing Division via email at [purchasing.requisitions@wv.gov](mailto:purchasing.requisitions@wv.gov).

- 41. BACKGROUND CHECK:** In accordance with W. Va. Code § 15-2D-3, the Director of the Division of Protective Services shall require any service provider whose employees are regularly employed on the grounds or in the buildings of the Capitol complex or who have access to sensitive or critical information to submit to a fingerprint-based state and federal background inquiry through the state repository. The service provider is responsible for any costs associated with the fingerprint-based state and federal background inquiry.

After the contract for such services has been approved, but before any such employees are permitted to be on the grounds or in the buildings of the Capitol complex or have access to sensitive or critical information, the service provider shall submit a list of all persons who will be physically present and working at the Capitol complex to the Director of the Division of Protective Services for purposes of verifying compliance with this provision.

The State reserves the right to prohibit a service provider's employees from accessing sensitive or critical information or to be present at the Capitol complex based upon results addressed from a criminal background check.

Service providers should contact the West Virginia Division of Protective Services by phone at (304) 558-9911 for more information.

- 42. PREFERENCE FOR USE OF DOMESTIC STEEL PRODUCTS:** Except when authorized by the Director of the Purchasing Division pursuant to W. Va. Code § 5A-3-56, no contractor may use or supply steel products for a State Contract Project other than those steel products made in the United States. A contractor who uses steel products in violation of this section may be subject to civil penalties pursuant to W. Va. Code § 5A-3-56. As used in this section:

- a. "State Contract Project" means any erection or construction of, or any addition to, alteration of or other improvement to any building or structure, including, but not limited to, roads or highways, or the installation of any heating or cooling or ventilating plants or other equipment, or the supply of and materials for such projects, pursuant to a contract with the State of West Virginia for which bids were solicited on or after June 6, 2001.
- b. "Steel Products" means products rolled, formed, shaped, drawn, extruded, forged, cast, fabricated or otherwise similarly processed, or processed by a combination of two or more or such operations, from steel made by the open heath, basic oxygen, electric furnace, Bessemer or other steel making process. The Purchasing Division Director may, in writing, authorize the use of foreign steel products if:
- c. The cost for each contract item used does not exceed one tenth of one percent (.1%) of the total contract cost or two thousand five hundred dollars (\$2,500.00), whichever is greater.

For the purposes of this section, the cost is the value of the steel product as delivered to the project; or

- d. The Director of the Purchasing Division determines that specified steel materials are not produced in the United States in sufficient quantity or otherwise are not reasonably available to meet contract requirements.

**43. PREFERENCE FOR USE OF DOMESTIC ALUMINUM, GLASS, AND STEEL:** In Accordance with W. Va. Code § 5-19-1 et seq., and W. Va. CSR § 148-10-1 et seq., for every contract or subcontract, subject to the limitations contained herein, for the construction, reconstruction, alteration, repair, improvement or maintenance of public works or for the purchase of any item of machinery or equipment to be used at sites of public works, only domestic aluminum, glass or steel products shall be supplied unless the spending officer determines, in writing, after the receipt of offers or bids, (1) that the cost of domestic aluminum, glass or steel products is unreasonable or inconsistent with the public interest of the State of West Virginia, (2) that domestic aluminum, glass or steel products are not produced in sufficient quantities to meet the contract requirements, or (3) the available domestic aluminum, glass, or steel do not meet the contract specifications. This provision only applies to public works contracts awarded in an amount more than fifty thousand dollars (\$50,000) or public works contracts that require more than ten thousand pounds of steel products.

The cost of domestic aluminum, glass, or steel products may be unreasonable if the cost is more than twenty percent (20%) of the bid or offered price for foreign made aluminum, glass, or steel products. If the domestic aluminum, glass or steel products to be supplied or produced in a "substantial labor surplus area", as defined by the United States Department of Labor, the cost of domestic aluminum, glass, or steel products may be unreasonable if the cost is more than thirty percent (30%) of the bid or offered price for foreign made aluminum, glass, or steel products.

This preference shall be applied to an item of machinery or equipment, as indicated above, when the item is a single unit of equipment or machinery manufactured primarily of aluminum, glass or steel, is part of a public works contract and has the sole purpose or of being a permanent part of a single public works project. This provision does not apply to equipment or machinery purchased by a spending unit for use by that spending unit and not as part of a single public works project.

All bids and offers including domestic aluminum, glass or steel products that exceed bid or offer prices including foreign aluminum, glass or steel products after application of the preferences provided in this provision may be reduced to a price equal to or lower than the lowest bid or offer price for foreign aluminum, glass or steel products plus the applicable preference. If the reduced bid or offer prices are made in writing and supersede the prior bid or offer prices, all bids or offers, including the reduced bid or offer prices, will be reevaluated in accordance with this rule.

**CERTIFICATION AND SIGNATURE PAGE**

By signing below, or submitting documentation through wvOASIS, I certify that I have reviewed this Solicitation in its entirety; understand the requirements, terms and conditions, and other information contained herein; that I am submitting this bid, offer or proposal for review and consideration; that I am authorized by the vendor to execute and submit this bid, offer, or proposal, or any documents related thereto on vendor's behalf; that I am authorized to bind the vendor in a contractual relationship; and that to the best of my knowledge, the vendor has properly registered with any State agency that may require registration.

FAIRPLAIN TRACTOR SALES, INC.

(Company)

*Carroll G. Fisher* CARROL G. FISHER, PRESIDENT  
(Authorized Signature) (Representative Name, Title)

304-372-9875 / 304-372-2731 5/7/2015  
(Phone Number) (Fax Number) (Date)

REQUEST FOR QUOTATION  
Sprayers, No-till Seed Drills, Rotary Cutters, Harrows and Discs

---

SPECIFICATIONS

1. **PURPOSE AND SCOPE:** The West Virginia Purchasing Division is soliciting bids on behalf of the West Virginia Division of Natural Resources' Wildlife Resources Section to establish a contract for the one time purchase of sprayers, no-till seed drills, rotary cutters, harrows and discs. All items will have minimum one year warranty. The award may be split if it is in the best interest of the West Virginia Division of Natural Resource.
  
1. **DEFINITIONS:** The terms listed below shall have the meanings assigned to them below. Additional definitions can be found in section 2 of the General Terms and Conditions.
  - 2.1 **"Contract Item"** means sprayers, no-till seed drills, rotary cutters, harrows and discs as more fully described by these specifications.
  - 2.2 **"Pricing Page"** means the pages, contained in wvOASIS or attached as Exhibit A, upon which Vendor should list its proposed price for the Contract Items.
  - 2.3 **"Solicitation"** means the official notice of an opportunity to supply the State with goods or services that is published by the Purchasing Division.
  
2. **GENERAL REQUIREMENTS:**
  - 3.1 **Mandatory Contract Item Requirements:** Contract Item must meet or exceed the mandatory requirements listed below.
    - 3.1.1 Item #1 - 175-200 gallon, three-point sprayer with the following specifications: All items must be new (2014-2015 model year), Ag Spray model RM200BXT43L or equal.
      - 3.1.1.1 Must have a minimum 175-200 maximum gallon corrosion resistant polyethylene tank.
      - 3.1.1.2 Must have a heaviest duty offered by manufacturer metal frame.
      - 3.1.1.3 Must have tank straps and braces.
      - 3.1.1.4 Must have a strainer assembly.
      - 3.1.1.5 Must have a pressure head assembly of at least 100 PSI.
      - 3.1.1.6 Must have pressure regulator for by-pass and agitation.

REQUEST FOR QUOTATION  
Sprayers, No-till Seed Drills, Rotary Cutters, Harrows and Discs

---

- 3.1.1.7 Must have manual valves for boom or nozzle control.
- 3.1.1.8 Must have Category 2 lift pins.
- 3.1.1.9 Must have Hypro Boom Extender Boomless nozzles with at least 36' coverage.
- 3.1.1.10 Must have handgun with minimum 25' of 3/8" rubber hose, gun holder and hose wrap.
- 3.1.1.11 Must have Hypro 8 roller pump with quick coupler.
- 3.1.2 Item #2 - 175-200 gallon, three-point sprayer with the following specifications:  
All items must be new (2014-2015 model year), Ag Spray model RM200BXT43L or equal.
  - 3.1.2.1 Must have a minimum 175-200 maximum gallon corrosion resistant polyethylene tank.
  - 3.1.2.2 Must have a heaviest duty offered by manufacturer metal frame.
  - 3.1.2.3 Must have tank straps and braces.
  - 3.1.2.4 Must have a strainer assembly.
  - 3.1.2.5 Must have a pressure head assembly of at least 100 PSI.
  - 3.1.2.6 Must have pressure regulator for by-pass and agitation.
  - 3.1.2.7 Must have manual valves for boom or nozzle control.
  - 3.1.2.8 Must have Category 2 lift pins.
  - 3.1.2.9 Must have Hypro Boom Extender Boomless nozzles with at least 36' coverage.
  - 3.1.2.10 Must have handgun with minimum 25' of 3/8" rubber hose, gun holder and hose wrap.
  - 3.1.2.11 Must have Hypro 8 roller pump with quick coupler.



REQUEST FOR QUOTATION  
Sprayers, No-till Seed Drills, Rotary Cutters, Harrows and Discs

---

- 3.1.3 Item #3 - Six-foot, heavy-duty, rotary cutter with the following specifications. All items must be new (2014 or 2015 model year), John Deere Model 609 or equal.
- 3.1.3.1 Must have a minimum 6' and a maximum 6 ½' cutting width.
  - 3.1.3.2 Must have a three-point lift Category 2 type hitch.
  - 3.1.3.3 Must have a minimum deck thickness of 0.18".
  - 3.1.3.4 Must have a minimum ASAE (American Society of Agricultural Engineers) Category 4 driveshaft.
  - 3.1.3.5 Must have a gearbox rated for a minimum 540 RPM.
  - 3.1.3.6 Must have a heavy-duty slip clutch driveline protection.
  - 3.1.3.7 Must have extra heavy duty blades – minimum of ½" thick and 4" wide.
  - 3.1.3.8 Must have laminated or caster wheel tires.
  - 3.1.3.9 Must have front and rear deflectors and front and rear chains.
  - 3.1.3.10 Must have a stump jumper or equal protection.
- 3.1.4 Item #4 - Six-foot, heavy-duty, rotary cutter with the following specifications: All items must be new (2014 or 2015 model year), John Deere Model 609 or equal.
- 3.1.4.1 Must have a minimum 6' and a maximum 6 ½' cutting width.
  - 3.1.4.2 Must have a three-point lift Category 2 type hitch.
  - 3.1.4.3 Must have a minimum deck thickness of 0.18".
  - 3.1.4.4 Must have a minimum ASAE (American Society of Agricultural Engineers) Category 4 driveshaft.
  - 3.1.4.5 Must have a gearbox rated for a minimum 540 RPM.
  - 3.1.4.6 Must have a heavy-duty slip clutch driveline protection.

REQUEST FOR QUOTATION  
Sprayers, No-till Seed Drills, Rotary Cutters, Harrows and Discs

---

- 3.1.4.7 Must have extra heavy duty blades – minimum of ½” thick and 4” wide.
  - 3.1.4.8 Must have laminated or caster wheel tires.
  - 3.1.4.9 Must have front and rear deflectors and front and rear chains.
  - 3.1.4.10 Must have a stump jumper or equal protection.
- 3.1.5 Item #5 - 110-gallon, three-point Sprayer with the following specifications: All items must be new (2014 or 2015 model year).
- 3.1.5.1 Must have a minimum 110-gallon polyethylene tank.
  - 3.1.5.2 Must have a heaviest-duty-offered-by-manufacturer metal frame.
  - 3.1.5.3 Must have tank straps and braces.
  - 3.1.5.4 Must have a strainer assembly.
  - 3.1.5.5 Must have a pressure head assembly.
  - 3.1.5.6 Must have pressure regulator for by-pass and agitation.
  - 3.1.5.7 Must have manual valves for boom or nozzle control.
  - 3.1.5.8 Must have Category 2 lift pins.
  - 3.1.5.9 Must have a 100 PSI liquid pressure gauge.
  - 3.1.5.10 Must have a 100 PSI dry pressure gauge.
  - 3.1.5.11 Must have a Hypro 8 roller pump with quick coupler.
  - 3.1.5.12 Must have a minimum of 25’ of 3/8” rubber hose, gun holder and hose wrap, #18 boomless tip which covers a minimum of 20°.
- 3.1.6 Item #6 – No-till seed drill with the following specifications: All items must be new (2014 or 2015 model year), Great Plains Model 706NT No-Till Seed Drill or equal.

REQUEST FOR QUOTATION  
Sprayers, No-till Seed Drills, Rotary Cutters, Harrows and Discs

---

- 3.1.6.1 Must have a minimum planting width of 7'.
  - 3.1.6.2 Must have a primary seed box capacity of 2.5 bushels per ft.
  - 3.1.6.3 Must have a small seed (legume) box for plants with small seeds (i.e. clover, alfalfa, switch grass) and a large grain seed box for plants with large seeds (i.e. wheat, soybeans, peas).
  - 3.1.6.4 Must have adjustable row spacing.
  - 3.1.6.5 Must have a warm season grass seed box.
  - 3.1.6.6 Must have an acre meter.
  - 3.1.6.7 Must have transport lights.
  - 3.1.6.8 Must have weight brackets.
  - 3.1.6.9 Must have water tight seed box lids.
  - 3.1.6.10 Must have lock out hubs and be eight ply highway tire compatible.
  - 3.1.6.11 Must have a folding hitch.
- 3.1.7 Item #7 - Disc harrow with the following specifications: All items must be new (2014 or 2015 model year), Frontier DH1508 or equal.
- 3.1.7.1 Must have a drawn type hitch with clevis and jack.
  - 3.1.7.2 Must have a minimum working width of 7' 6" to a maximum width of 8'.
  - 3.1.7.3 Must have a minimum 7.5" and a maximum 8.5" blade spacing.
  - 3.1.7.4 Must have minimum of 22 and a maximum of 24 blades.
  - 3.1.7.5 Must have minimum 22" and a maximum 24" blade size.
  - 3.1.7.6 Must have notched blades on front gangs and smooth blades on rear gangs.
  - 3.1.7.7 Must have a minimum of 5" x 3" square tubing wall frame.

REQUEST FOR QUOTATION  
Sprayers, No-till Seed Drills, Rotary Cutters, Harrows and Discs

---

- 3.1.7.8 Must have a minimum of 3" x 3" gang tubing.
  - 3.1.7.9 Must have adjustable gang angles.
  - 3.1.7.10 Must have a minimum 2" x 4" steel tube gang hangers.
  - 3.1.7.11 Must have minimum of sealed bearings on gang hangers.
  - 3.1.7.12 Must have a minimum of 1 1/8" gang axles.
  - 3.1.7.13 Must have a minimum single wheel transportation kit with implement tires, hydraulic cylinder lift, and hydraulic hoses attached.
  - 3.1.7.14 Must be fully assembled.
- 3.1.8** Item #8 - 175-200 gallon, three-point sprayer with the following specifications: All items must be new (2014-2015 model year), Ag Spray model RM200BXT43L or equal.
- 3.1.8.1 Must have a minimum 175-200 maximum gallon corrosion resistant polyethylene tank.
  - 3.1.8.2 Must have a heaviest duty offered by manufacturer metal frame.
  - 3.1.8.3 Must have tank straps and braces.
  - 3.1.8.4 Must have a strainer assembly.
  - 3.1.8.5 Must have a pressure head assembly of at least 100 PSI.
  - 3.1.8.6 Must have pressure regulator for by-pass and agitation.
  - 3.1.8.7 Must have manual valves for boom or nozzle control.
  - 3.1.8.8 Must have Category 2 lift pins.
  - 3.1.8.9 Must have Hypro Boom Extender Boomless nozzles with at least 36' coverage.
  - 3.1.8.10 Must have handgun with minimum 25' of 3/8" rubber hose, gun holder and hose wrap.
  - 3.1.8.11 Must have Hypro 8 roller pump with quick coupler.

REQUEST FOR QUOTATION  
Sprayers, No-till Seed Drills, Rotary Cutters, Harrows and Discs

---

- 3.1.9 Item #9 - Disc harrow with the following specifications: All items must be new (2014 or 2015 model year), Tuflin Model TL43-91620 or equal.
- 3.1.9.1 Must be tractor rated for 40 to 70 HP.
  - 3.1.9.2 Must have a minimum 6' and maximum 6 ½' cutting width.
  - 3.1.9.3 Must have a minimum 4 by 3 square inch heavy wall frame.
  - 3.1.9.4 Must have a Category 2 three-point hitch and be quick hitch compatible.
  - 3.1.9.5 Must have minimum square gang axles of 1 1/8" with heavy tube gang hangers.
  - 3.1.9.6 Must have an adjustable gang axle.
  - 3.1.9.7 Must have sealed bearings.
  - 3.1.9.8 Must have a minimum weight of 1,150 lbs.
  - 3.1.9.9 Must have a minimum 20" and a maximum 22" blade size.
  - 3.1.9.10 Must have notched blades on front gangs and smooth blades on rear gangs.
- 3.1.10 Item #10 - UTV skid-type sprayer designed to fit a Polaris Ranger UTV with the following specifications: All items must be new (2014 or 2015 model year), F/S Manufacturing Inc. Model Boomless hypro or equal.
- 3.1.10.1 Must have heaviest-duty-offered-by-manufacture skid type metal frame.
  - 3.1.10.2 Must have a minimum of a 100 gallon chemical and UV resistant polymer tank.
  - 3.1.10.3 Must have a Hypro 8 roller pump with a minimum of 4 GPM flow rate or equivalent.
  - 3.1.10.4 Must have a minimum of a 160cc Honda OHV engine or equal.

REQUEST FOR QUOTATION  
Sprayers, No-till Seed Drills, Rotary Cutters, Harrows and Discs

---

- 3.1.10.5 Must have hand gun sprayer with minimum of 100' x 3/8" hose.
- 3.1.10.6 Must have manual rewind hose reel with a capacity to hold 100' x 3/8" hose.
- 3.1.10.7 Must have boomless nozzles with a minimum spray distance of 18'.
- 3.1.10.8 Must have pressure return and agitation.
- 3.1.10.9 Must have 100 PSI liquid filled pressure gauge or equal.
- 3.1.10.10 Must have manual controls with shutoff and regulating valves for hand wand and boomless sprayer.
- 3.1.10.11 Must have tank straps and braces.
- 3.1.10.12 Must have strainer assembly.
  
- 3.1.11 Item #11 - Heavy duty, offset disc with the following specifications: All items must be new (2014 or 2015 model year), Tuflin Model 38/101824 or equal.
  - 3.1.11.1 Must have a minimum cutting width of 7 1/2' and a maximum of less than 8 1/2'.
  - 3.1.11.2 Must have a minimum of 24" and a maximum of 26" notched disc blades.
  - 3.1.11.3 Must have a minimum of 10" and a maximum of 10 1/2" disc blade spacing.
  - 3.1.11.4 Must be equipped with flexible style gang hangers.
  - 3.1.11.5 Must be equipped with adjustable, disc blade scrappers.
  - 3.1.11.6 Must be equipped with a hydraulic lift, single-wheel carriage assembly.
  - 3.1.11.7 Must be equipped with a transport hydraulic cylinder and host kit.
  - 3.1.11.8 Must be equipped with a mechanical system for side draft control.

REQUEST FOR QUOTATION  
Sprayers, No-till Seed Drills, Rotary Cutters, Harrows and Discs

---

- 3.1.11.9. Must be equipped with implement tires.
- 3.1.11.10 Must have a pull-type hitch.
- 3.1.12 Item #12 - Heavy duty offset disc with the following specifications: All items must be new (2014 or 2015 model year), Tuflin Model 38/101824 or equal.
  - 3.1.12.1 Must have a minimum cutting width of 7 1/2' and a maximum of less than 8 1/2'.
  - 3.1.12.2 Must have a minimum of 24" and a maximum of 26" notched disc blades.
  - 3.1.12.3 Must have a minimum of 10" and a maximum of 10 1/2" disc blade spacing.
  - 3.1.12.4 Must be equipped with flexible style gang hangers.
  - 3.1.12.5 Must be equipped with adjustable, disc blade scrappers.
  - 3.1.12.6 Must be equipped with a hydraulic lift, single-wheel carriage assembly.
  - 3.1.12.7 Must be equipped with a transport hydraulic cylinder and host kit.
  - 3.1.12.8 Must be equipped with a mechanical system for side draft control.
  - 3.1.12.9 Must be equipped with implement tires.
  - 3.1.12.10 Must have a pull-type hitch.
- 3.1.13 Item #13 - No till seed drill with the following specifications: All items must be new (2014 or 2105 model year), Great Plains Model 3P606NT or equal.
  - 3.1.13.1 Must have three-point mount.
  - 3.1.13.2 Must have Category II setup.
  - 3.1.13.3 Must have calibration crank.
  - 3.1.13.4 Must have ground-driven metering system.

REQUEST FOR QUOTATION  
Sprayers, No-till Seed Drills, Rotary Cutters, Harrows and Discs

---

- 3.1.13.5 Must have 5/16" fluted coulter blades.
  - 3.1.13.6 Must have main seedbox, native grass seedbox, small seedbox.
  - 3.1.13.7 Must have rain tight seedbox lids.
  - 3.1.13.8 Must have an acre meter.
  - 3.1.13.9 Must have row spacings of 7.5".
  - 3.1.13.10 Must have seed cup plugs.
  - 3.1.13.11 Must have seed level indicator.
  - 3.1.13.12 Must have a minimum 6' and maximum 7' planting width.
- 3.1.14 Item #14 - 175-200 gallon, three-point sprayer with the following specifications:  
All items must be new (2014-2015 model year), Ag Spray model RM200BXT43L or equal.
- 3.1.14.1 Must have a minimum 175-200 maximum gallon corrosion resistant polyethylene tank.
  - 3.1.14.2 Must have a heaviest duty offered by manufacturer metal frame.
  - 3.1.14.3 Must have tank straps and braces.
  - 3.1.14.4 Must have a strainer assembly.
  - 3.1.14.5 Must have a pressure head assembly of at least 100 PSI.
  - 3.1.14.6 Must have pressure regulator for by-pass and agitation.
  - 3.1.14.7 Must have manual valves for boom or nozzle control.
  - 3.1.14.8 Must have Category 2 lift pins.
  - 3.1.14.9 Must have Hypro boom extender boomless nozzles with at least 36' coverage.
  - 3.1.14.10 Must have handgun with minimum 25' of 3/8" rubber hose, gun holder and hose wrap.



REQUEST FOR QUOTATION  
Sprayers, No-till Seed Drills, Rotary Cutters, Harrows and Discs

---

3.1.14.11 Must have Hypro 8 roller pump with quick coupler.

3.1.15 Item #15 - 175-200 gallon, three-point sprayer with the following specifications:  
All items must be new (2014-2015 model year), Ag Spray model RM200BXT43L  
or equal.

3.1.15.1 Must have a minimum 175-200 maximum gallon corrosion  
resistant polyethylene tank.

3.1.15.2 Must have a heaviest duty offered by manufacturer metal  
frame.

3.1.15.3 Must have tank straps and braces.

3.1.15.4 Must have a strainer assembly.

3.1.15.5 Must have a pressure head assembly of at least 100 PSI.

3.1.15.6 Must have pressure regulator for by-pass and agitation.

3.1.15.7 Must have manual valves for boom or nozzle control.

3.1.15.8 Must have Category 2 lift pins.

3.1.15.9 Must have Hypro boom extender boomless nozzles with at  
least 36' coverage.

3.1.15.10 Must have handgun with minimum 25' of 3/8" rubber hose,  
gun holder and hose wrap.

3.1.15.11 Must have Hypro 8 roller pump with quick coupler.

### 3. CONTRACT AWARD:

**4.1 Contract Award:** The Contract is intended to provide Agencies with a purchase price for the Contract Items. The Contract shall be awarded to the Vendor or multiple Vendors that provide the Contract Items meeting the required specifications for the lowest overall total cost as shown on the Pricing Pages.

**4.2 Pricing Page:** Vendor should complete the Pricing Page by including price per line item that includes shipping fees. Vendor should complete the Pricing Page in full as failure to complete the Pricing Page in its entirety may result in Vendor's bid being disqualified.

REQUEST FOR QUOTATION  
Sprayers, No-till Seed Drills, Rotary Cutters, Harrows and Discs

---

Vendor should type or electronically enter the information into the Pricing Page to prevent errors in the evaluation.

**4. PAYMENT:**

**5.1 Payment:** Vendor shall accept payment in accordance with the payment procedures of the State of West Virginia.

**5. DELIVERY AND RETURN:**

**6.1 Shipment and Delivery:** Vendor shall ship the Contract Items immediately after being awarded this Contract and receiving a purchase order or notice to proceed. Vendor shall deliver the Contract Items within forty-five (45) working days after receiving a purchase order or notice to proceed. Contract items must be delivered to Agency at the following locations.

- 6.1.1 **Item #1** WV Division of Natural Resources, Hillcrest WMA, District 1 DNR Office, Farmington, WV (Marion County); Contact person: Steve Rauch (304-825-6787) for delivery information.
- 6.1.2 **Item #2** WV Division of Natural Resources, District 1 DNR Office, Farmington, WV (Marion County); Contact person: Steve Rauch (304-825-6787) for delivery information.
- 6.1.3 **Item #3** WV Division of Natural Resources, Wardensville WMA, District 2 DNR Office, Romney, WV (Hampshire County); Contact person: Rich Rogers (304-822-3551) for delivery information.
- 6.1.4 **Item #4** WV Division of Natural Resources, Shenandoah WMA, District 2 DNR Office, Romney, WV (Hampshire County); Contact person: Rich Rogers (304-822-3551) for delivery information.
- 6.1.5 **Item #5** WV Division of Natural Resources, Shenandoah WMA, District 2 DNR Office, Romney, WV (Hampshire County); Contact person: Rich Rogers (304-822-3551) for delivery information.
- 6.1.6 **Item #6** WV Division of Natural Resources, Stonewall Jackson Lake WMA, District 3 DNR Office, French Creek, WV (Upshur County); Contact person: Rob Silvester (304-924-6211) for delivery information.

REQUEST FOR QUOTATION  
Sprayers, No-till Seed Drills, Rotary Cutters, Harrows and Discs

---

- 6.1.7 **Item #7** WV Division of Natural Resources, Beaver Dam WMA, District 3 DNR Office, French Creek, WV (Upshur County); Contact person: Rob Silvester (304-924-6211) for delivery information.
  - 6.1.8 **Item #8** WV Division of Natural Resources, Beaver Dam WMA, District 3 DNR Office, French Creek, WV (Upshur County); Contact person: Rob Silvester (304-924-6211) for delivery information.
  - 6.1.9 **Item #9** WV Division of Natural Resources, Rimel WMA, District 3 DNR Office, French Creek, WV (Upshur County); Contact person: Rob Silvester (304-924-6211) for delivery information.
  - 6.1.10 **Item #10** WV Division of Natural Resources, Elk River WMA, District 3 DNR Office, French Creek, WV (Upshur County); Contact person: Rob Silvester (304-924-6211) for delivery information.
  - 6.1.11 **Item #11** WV Division of Natural Resources, R. D. Bailey WMA, District 4 DNR Office, Beckley, WV (Raleigh County); Contact person: Todd Dowdy (304-304-256-6947) for delivery information.
  - 6.1.12 **Item #12** WV Division of Natural Resources, Beury Mtn. WMA, District 4 DNR Office, Beckley, WV (Raleigh County); Contact person: Todd Dowdy (304-304-256-6947) for delivery information.
  - 6.1.13 **Item #13** WV Division of Natural Resources, R. D. Bailey WMA, District 4 DNR Office, Beckley, WV (Raleigh County); Contact person: Todd Dowdy (304-304-256-6947) for delivery information.
  - 6.1.14 **Item #14** WV Division of Natural Resources, Panther State Forest, District 4 DNR Office, Beckley, WV (Raleigh County); Contact person: Todd Dowdy (304-304-256-6947) for delivery information.
  - 6.1.15 **Item #15** WV Division of Natural Resources, Neola WMA, District 4 DNR Office, Beckley, WV (Raleigh County); Contact person: Todd Dowdy (304-304-256-6947) for delivery information.
- 6.2 Late Delivery:** The Agency placing the order under this Contract must be notified in writing if the shipment of the Contract Items will be delayed for any reason. Any delay in delivery that could cause harm to an Agency will be grounds for cancellation of the Contract, and/or obtaining the Contract Items from a third party.

REQUEST FOR QUOTATION  
Sprayers, No-till Seed Drills, Rotary Cutters, Harrows and Discs

---

Any Agency seeking to obtain the Contract Items from a third party under this provision must first obtain approval of the Purchasing Division.

- 6.3 **Delivery Payment/Risk of Loss:** Vendor shall deliver the Contract Items F.O.B. destination to the Agency's location.
  
- 6.4 **Return of Unacceptable Items:** If the Agency deems the Contract Items to be unacceptable, the Contract Items shall be returned to Vendor at Vendor's expense and with no restocking charge. Vendor shall either make arrangements for the return within five (5) days of being notified that items are unacceptable, or permit the Agency to arrange for the return and reimburse Agency for delivery expenses. If the original packaging cannot be utilized for the return, Vendor will supply the Agency with appropriate return packaging upon request. All returns of unacceptable items shall be F.O.B. the Agency's location. The returned product shall either be replaced, or the Agency shall receive a full credit or refund for the purchase price, at the Agency's discretion.
  
- 6.5 **Return Due to Agency Error:** Items ordered in error by the Agency will be returned for credit within 30 days of receipt, F.O.B. Vendor's location. Vendor shall not charge a restocking fee if returned products are in a resalable condition. Items shall be deemed to be in a resalable condition if they are unused and in the original packaging. Any restocking fee for items not in a resalable condition shall be the lower of the Vendor's customary restocking fee or 5% of the total invoiced value of the returned items.

**7 VENDOR DEFAULT:**

- 7.1 The following shall be considered a vendor default under this Contract.
  - 7.1.1 Failure to provide Contract Items in accordance with the requirements contained herein.
  
  - 7.1.2 Failure to comply with other specifications and requirements contained herein.
  
  - 7.1.3 Failure to comply with any laws, rules, and ordinances applicable to the Contract Services provided under this Contract.
  
  - 7.1.4 Failure to remedy deficient performance upon request.
  
- 7.2 The following remedies shall be available to Agency upon default.
  - 7.2.1 Immediate cancellation of the Contract.

REQUEST FOR QUOTATION  
Sprayers, No-till Seed Drills, Rotary Cutters, Harrows and Discs

---

- 7.2.2 Immediate cancellation of one or more release orders issued under this Contract.
- 7.2.3 Any other remedies available in law or equity.

Exhibit A - Pricing Page

Item No.	Description	Manufacturer and Model for "or equal" bids	Qty	Unit Price	Extended Price
1	3 POINT SPRAYER	DEMCO 200 GALLON	1	\$ 4328.00	\$ 4328.00
2	3 POINT SPRAYER	DEMCO 200 GALLON	1	\$ 4328.00	\$ 4328.00
3	BUSH HOG HD	HD LAND PRIDE RCF 3672	1	\$ 4285.00	\$ 4285.00
4	BUSH HOG HD	HD LAND PRIDE RCF 3672	1	\$ 4285.00	\$ 4285.00
5	110 GALLON SPRAYER	DEMCO PRO SERIES	1	\$ 2875.00	\$ 2875.00
6	NO-TILL DRILL	LAND PRIDE – GREAT PLAINS 706NT	1	\$25,800.00	\$25,800.00
7	TANDEM PULL TYPE DISC 8 FOOT	TUFLINE TW 72422	1	\$ 5975.00	\$ 5975.00
8	3 POINT SPRAYER	DEMCO 200 GALLON	1	\$ 4328.00	\$ 4328.00
9	DISC HARROW 8 FOOT	TUFLINE TW 72422	1	\$ 5975.00	\$ 5975.00
10	UTZ SKID TYPE SPRAYER	DEMCO RM SERIES	1	\$ 2995.00	\$ 2995.00
11	HD OFFSET DISC	TUFLINE 38-101824SF	1	\$ 9150.00	\$ 9150.00
12	HD OFFSET DISC	TUFLINE 38-101824SF	1	\$ 9150.00	\$ 9150.00
13	NO-TILL DRILL	LAND PRIDE – GREAT PLAINS 3P606NT	1	\$15,611.00	\$15,611.00
14	200 GALLON SPRAYER	DEMCO	1	\$ 4238.00	\$ 4238.00
15	200 GALLON SPRAYER	DEMCO	1	\$ 4238.00	\$ 4238.00
<b>TOTAL BIDAMOUNT</b>					<b>\$107,561.00</b>

Items are to be delivered within forty-five (45) working days to the following locations:

- Item #1 WV Division of Natural Resources, Hillcrest WMA, District 1 DNR Office, Farmington, WV (Marion County); Contact person: Steve Rauch (304-825-6787) for delivery information.
- Item #2 WV Division of Natural Resources, District 1 DNR Office, Farmington, WV (Marion County); Contact person: Steve Rauch (304-825-6787) for delivery information.
- Item #3 WV Division of Natural Resources, Wardensville WMA, District 2 DNR Office, Romney, WV (Hampshire County); Contact person: Rich Rogers (304-822-3551) for delivery information.
- Item #4 WV Division of Natural Resources, Shenandoah WMA, District 2 DNR Office, Romney, WV (Hampshire County); Contact person: Rich Rogers (304-822-3551) for delivery information.
- Item #5 WV Division of Natural Resources, Shenandoah WMA, District 2 DNR Office, Romney, WV (Hampshire County); Contact person: Rich Rogers (304-822-3551) for delivery information.
- Item #6 WV Division of Natural Resources, Stonewall Jackson Lake WMA, District 3 DNR Office, French Creek, WV (Upshur County); Contact person: Rob Silvester (304-924-6211) for delivery information.
- Item #7 WV Division of Natural Resources, Beaver Dam WMA, District 3 DNR Office, French Creek, WV (Upshur County); Contact person: Rob Silvester (304-924-6211) for delivery information.
- Item #8 WV Division of Natural Resources, Beaver Dam WMA, District 3 DNR Office, French Creek, WV (Upshur County); Contact person: Rob Silvester (304-924-6211) for delivery information.
- Item #9 WV Division of Natural Resources, Rimel WMA, District 3 DNR Office, French Creek, WV (Upshur County); Contact person: Rob Silvester (304-924-6211) for delivery information.
- Item #10 WV Division of Natural Resources, Elk River WMA, District 3 DNR Office, French Creek, WV (Upshur County); Contact person: Rob Silvester (304-924-6211) for delivery information.
- Item #11 WV Division of Natural Resources, R. D. Bailey WMA, District 4 DNR Office, Beckley, WV (Raleigh County); Contact person: Todd Dowdy (304-304-256-6947) for delivery information.
- Item #12 WV Division of Natural Resources, Beury Mtn. WMA, District 4 DNR Office, Beckley, WV (Raleigh County); Contact person: Todd Dowdy (304-304-256-6947) for delivery information.
- Item #13 WV Division of Natural Resources, R. D. Bailey WMA, District 4 DNR Office, Beckley, WV (Raleigh County); Contact person: Todd Dowdy (304-304-256-6947) for delivery information.
- Item #14 WV Division of Natural Resources, Panther State Forest, District 4 DNR Office, Beckley, WV (Raleigh County); Contact person: Todd Dowdy (304-304-256-6947) for delivery information.
- Item #15 WV Division of Natural Resources, Neola WMA, District 4 DNR Office, Beckley, WV (Raleigh County); Contact person: Todd Dowdy (304-304-256-6947) for delivery information.

\*If bidding "or equal" brands, vendor must include manufacturer's literature documenting it meets the mandatory requirements stated in the specifications. Vendors should note the areas of the provided manufacturer's literature that adheres to the mandatory requirements outlined in the RFQ.

State of West Virginia  
**VENDOR PREFERENCE CERTIFICATE**

Certification and application\* is hereby made for Preference in accordance with *West Virginia Code*, §5A-3-37. (Does not apply to construction contracts). *West Virginia Code*, §5A-3-37, provides an opportunity for qualifying vendors to request (at the time of bid) preference for their residency status. Such preference is an evaluation method only and will be applied only to the cost bid in accordance with the *West Virginia Code*. This certificate for application is to be used to request such preference. The Purchasing Division will make the determination of the Vendor Preference, if applicable.

1. **Application is made for 2.5% vendor preference for the reason checked:**  
 Bidder is an individual resident vendor and has resided continuously in West Virginia for four (4) years immediately preceding the date of this certification; or  
 Bidder is a partnership, association or corporation resident vendor and has maintained its headquarters or principal place of business continuously in West Virginia for four (4) years immediately preceding the date of this certification; or 80% of the ownership interest of Bidder is held by another individual, partnership, association or corporation resident vendor who has maintained its headquarters or principal place of business continuously in West Virginia for four (4) years immediately preceding the date of this certification; or  
 Bidder is a nonresident vendor which has an affiliate or subsidiary which employs a minimum of one hundred state residents and which has maintained its headquarters or principal place of business within West Virginia continuously for the four (4) years immediately preceding the date of this certification; or,
2. **Application is made for 2.5% vendor preference for the reason checked:**  
 Bidder is a resident vendor who certifies that, during the life of the contract, on average at least 75% of the employees working on the project being bid are residents of West Virginia who have resided in the state continuously for the two years immediately preceding submission of this bid; or,
3. **Application is made for 2.5% vendor preference for the reason checked:**  
 Bidder is a nonresident vendor employing a minimum of one hundred state residents or is a nonresident vendor with an affiliate or subsidiary which maintains its headquarters or principal place of business within West Virginia employing a minimum of one hundred state residents who certifies that, during the life of the contract, on average at least 75% of the employees or Bidder's affiliate's or subsidiary's employees are residents of West Virginia who have resided in the state continuously for the two years immediately preceding submission of this bid; or,
4. **Application is made for 5% vendor preference for the reason checked:**  
 Bidder meets either the requirement of both subdivisions (1) and (2) or subdivision (1) and (3) as stated above; or,
5. **Application is made for 3.5% vendor preference who is a veteran for the reason checked:**  
 Bidder is an individual resident vendor who is a veteran of the United States armed forces, the reserves or the National Guard and has resided in West Virginia continuously for the four years immediately preceding the date on which the bid is submitted; or,
6. **Application is made for 3.5% vendor preference who is a veteran for the reason checked:**  
 Bidder is a resident vendor who is a veteran of the United States armed forces, the reserves or the National Guard, if, for purposes of producing or distributing the commodities or completing the project which is the subject of the vendor's bid and continuously over the entire term of the project, on average at least seventy-five percent of the vendor's employees are residents of West Virginia who have resided in the state continuously for the two immediately preceding years.
7. **Application is made for preference as a non-resident small, women- and minority-owned business, in accordance with *West Virginia Code* §5A-3-59 and *West Virginia Code of State Rules*.**  
 Bidder has been or expects to be approved prior to contract award by the Purchasing Division as a certified small, women- and minority-owned business.

Bidder understands if the Secretary of Revenue determines that a Bidder receiving preference has failed to continue to meet the requirements for such preference, the Secretary may order the Director of Purchasing to: (a) reject the bid; or (b) assess a penalty against such Bidder in an amount not to exceed 5% of the bid amount and that such penalty will be paid to the contracting agency or deducted from any unpaid balance on the contract or purchase order.

By submission of this certificate, Bidder agrees to disclose any reasonably requested information to the Purchasing Division and authorizes the Department of Revenue to disclose to the Director of Purchasing appropriate information verifying that Bidder has paid the required business taxes, provided that such information does not contain the amounts of taxes paid nor any other information deemed by the Tax Commissioner to be confidential.

Under penalty of law for false swearing (*West Virginia Code*, §61-5-3), Bidder hereby certifies that this certificate is true and accurate in all respects; and that if a contract is issued to Bidder and if anything contained within this certificate changes during the term of the contract, Bidder will notify the Purchasing Division in writing immediately.

Bidder: CARROLL G. FISHER

Signed: Carroll G. Fisher

Date: 5/7/2015

Title: PRESIDENT

STATE OF WEST VIRGINIA  
Purchasing Division**PURCHASING AFFIDAVIT**

**MANDATE:** Under W. Va. Code §5A-3-10a, no contract or renewal of any contract may be awarded by the state or any of its political subdivisions to any vendor or prospective vendor when the vendor or prospective vendor or a related party to the vendor or prospective vendor is a debtor and: (1) the debt owed is an amount greater than one thousand dollars in the aggregate; or (2) the debtor is in employer default.

**EXCEPTION:** The prohibition listed above does not apply where a vendor has contested any tax administered pursuant to chapter eleven of the W. Va. Code, workers' compensation premium, permit fee or environmental fee or assessment and the matter has not become final or where the vendor has entered into a payment plan or agreement and the vendor is not in default of any of the provisions of such plan or agreement.

**DEFINITIONS:**

**"Debt"** means any assessment, premium, penalty, fine, tax or other amount of money owed to the state or any of its political subdivisions because of a judgment, fine, permit violation, license assessment, defaulted workers' compensation premium, penalty or other assessment presently delinquent or due and required to be paid to the state or any of its political subdivisions, including any interest or additional penalties accrued thereon.

**"Employer default"** means having an outstanding balance or liability to the old fund or to the uninsured employers' fund or being in policy default, as defined in W. Va. Code § 23-2c-2, failure to maintain mandatory workers' compensation coverage, or failure to fully meet its obligations as a workers' compensation self-insured employer. An employer is not in employer default if it has entered into a repayment agreement with the Insurance Commissioner and remains in compliance with the obligations under the repayment agreement.

**"Related party"** means a party, whether an individual, corporation, partnership, association, limited liability company or any other form or business association or other entity whatsoever, related to any vendor by blood, marriage, ownership or contract through which the party has a relationship of ownership or other interest with the vendor so that the party will actually or by effect receive or control a portion of the benefit, profit or other consideration from performance of a vendor contract with the party receiving an amount that meets or exceeds five percent of the total contract amount.

**AFFIRMATION:** By signing this form, the vendor's authorized signer affirms and acknowledges under penalty of law for false swearing (W. Va. Code §61-5-3) that neither vendor nor any related party owe a debt as defined above and that neither vendor nor any related party are in employer default as defined above, unless the debt or employer default is permitted under the exception above.

**WITNESS THE FOLLOWING SIGNATURE:**Vendor's Name: FAIRPLAIN TRACTOR SALES, INC.Authorized Signature: *Connell M Fisher* Date: 5/7/2015State of WEST VIRGINIACounty of JACKSON, to-wit:Taken, subscribed, and sworn to before me this 7 day of MAY, 2015My Commission expires SEPTEMBER 26, 2021

AFFIX SEAL HERE

NOTARY PUBLIC

*Terri Lee Hackney*

Purchasing Affidavit (Revised 07/01/2012)

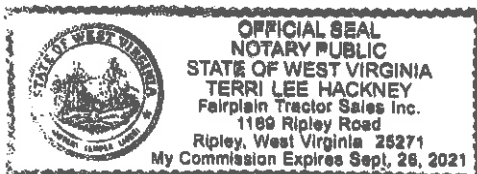





# 706NT

## END WHEEL

**No-Till**  
Compact Drill

## 706NT

[Features \(#tabs-1\)](#)
[Specs, Manuals & Warranty \(#tabs-2\)](#)
[Videos, Images and Literature \(#tabs-3\)](#)

### Product Specifications

MODEL INFO	7, Pull-Type
MODELS	706NT
PRIMARY DESIGN	End Wheel No-Till
ROW SPACINGS	7" (17.8 cm), 7.5" (19.05 cm), 8" (20.32 cm)
NUMBER OF OPENERS	11, 16, 18
TIRE SIZE	6.00 x 24 8-ply
Hp REQUIREMENTS (min)	55 hp
WEIGHT (Approx.)	3,900 lbs (1,766 kg)
DIMENSIONS	
WORKING WIDTH	7' (2.13 m)
WIDTH	41 1/2" (3.00 m)
LENGTH (transport)	7'10" (4.22 m)
CLEARANCE (transport)	13.5" (34.28 cm)
HEIGHT (transport)	67" (2.0 m)
OPENER INFO	
OPENER SERIES	66 Series
OPENER TRAVEL	0.5' (16.51 cm)
OPENER DEPTH RANGE	0-5.5" (0-8.89 cm)
OPENER DOWN PRESSURE	90-180 lbs (40.82-81.64 kg)
COULTER	5/8" Tubular 5/16" Fluted
COULTER PRE-LOAD	450 lbs (203 kg)
CAPACITIES	
MAIN BOX CAPACITY	12.5 bu

SMALL SEED BOX	1.68 bu.
NATIVE GRASS BOX	7 bu.
FERTILIZER	0.5 cu ft.
2ND MAIN BOX	7 bu.

\* Weights based on 7-1/2" row spacing with main seedbox only. Weights will vary with options.

### Product Specifications PDF ([http://www.greatplainsmfg.com/pdf/specs/Compact Drills Specs.pdf](http://www.greatplainsmfg.com/pdf/specs/Compact%20Drills%20Specs.pdf))

Download the product specifications here: [Compact Drills Specs.pdf](http://www.greatplainsmfg.com/pdf/specs/Compact%20Drills%20Specs.pdf)  
([http://www.greatplainsmfg.com/pdf/specs/Compact Drills Specs.pdf](http://www.greatplainsmfg.com/pdf/specs/Compact%20Drills%20Specs.pdf))

### Warranty PDF (<http://www.greatplainsmfg.com/pdf/warranty/Warranty.pdf>)

Download the warranty here: [Warranty.pdf](http://www.greatplainsmfg.com/pdf/warranty/Warranty.pdf) (<http://www.greatplainsmfg.com/pdf/warranty/Warranty.pdf>)

## 706NT, 1006NT, 1205NT High Rate Fertilizer Sprockets

### Standard Manuals

**Options: English: 150-242m.pdf** ([http://cdn-ag.greatplainsmfg.com/cdn/farfuture/aJ\\_cIYFschyjXqBLAvKsptRUIlvMjtQY\\_Lpfy9abXI/mtime:1360169627/sites/default/files/manuals/pdf/150-242m.pdf](http://cdn-ag.greatplainsmfg.com/cdn/farfuture/aJ_cIYFschyjXqBLAvKsptRUIlvMjtQY_Lpfy9abXI/mtime:1360169627/sites/default/files/manuals/pdf/150-242m.pdf))

### Related Product Pages

The following are links to details and specifications for products that utilize this set of manuals: [706NT](/en/products/767/706nt) (</en/products/767/706nt>) ; [1006NT Compact Drill](/en/products/771/1006nt-compact-drill) (</en/products/771/1006nt-compact-drill>) .

## 706NT and 1006NT End Wheel No-Till Drills (2006-)

### Standard Manuals

**Operator: English: 150-285m.pdf (rev.2007-01-03)** (<http://cdn-ag.greatplainsmfg.com/cdn/farfuture/PGr6Kyx8BQ7cFzCFIfqBXNDUSakWk-K8bguP7Em2x2k/mtime:1429813143/sites/default/files/manuals/pdf/150-285m.pdf>)

**Parts: English: 150-285p.pdf (rev.2014-07-22)** (<http://cdn-ag.greatplainsmfg.com/cdn/farfuture/OQria2QOX2dE60AeZYpyPRgS7EUd43Mbk9ULfqMhvEg/mtime:1406142952/sites/default/files/manuals/pdf/150-285p.pdf>)

**Material Rate: English: 150-285b.pdf (rev.2007-04-20)** (<http://cdn-ag.greatplainsmfg.com/cdn/farfuture/XNk1e081UoDHIMh6fyaNXIBexAfuDcyIH7DoXJTajM/mtime:1193853723/sites/default/files/manuals/pdf/150-285b.pdf>)

### Notes

Manuals for current 7- and 10-Foot No-Till End-Wheel drills are found at [No-Till Drills](http://www.greatplainsag.com/en/manuals/910/no-till-drill-manuals) (<http://www.greatplainsag.com/en/manuals/910/no-till-drill-manuals>) > [706NT](http://www.greatplainsag.com/en/manuals/910/no-till-drill-manuals#set-node-1404) (<http://www.greatplainsag.com/en/manuals/910/no-till-drill-manuals#set-node-1404>) .

### Related Product Pages

The following are links to details and specifications for products that utilize this set of manuals: [706NT](/en/products/767/706nt) (</en/products/767/706nt>) ; [1006NT Compact Drill](/en/products/771/1006nt-compact-drill) (</en/products/771/1006nt-compact-drill>) .

## 706NT and 1006NT End Wheel No-Till Drills (2007-)

### Standard Manuals

**Operator: English: 150-285m.pdf (rev.2007-01-03)** (<http://cdn-ag.greatplainsmfg.com/cdn/farfuture/PGr9Kyx6BQ7cFzCFIfqBXN0USakWt-K8bgUP7Em2x2k/mtime:1429813143/sites/default/files/manuals/pdf/150-285m.pdf>)

**Operator: Russian: 150-285m-rus.pdf (rev.2007-01-03)** ([http://cdn-ag.greatplainsmfg.com/cdn/farfuture/tcefWC38l1\\_frKdBetgqLL2C9fUsWvALVae4yvjXVo/mtime:1367855364/sites/default/files/manuals/pdf/150-285m-rus.pdf](http://cdn-ag.greatplainsmfg.com/cdn/farfuture/tcefWC38l1_frKdBetgqLL2C9fUsWvALVae4yvjXVo/mtime:1367855364/sites/default/files/manuals/pdf/150-285m-rus.pdf))

**Parts: English: 150-285p.pdf (rev.2014-07-22)** (<http://cdn-ag.greatplainsmfg.com/cdn/farfuture/OQrla2QOX2dE60AeZYpyPRgS7EUd43Mbk9ULfqMhvEg/mtime:1406142952/sites/default/files/manuals/pdf/150-285p.pdf>)

**Material Rate: English: 150-287b.pdf (rev.2007-04-20)** (<http://cdn-ag.greatplainsmfg.com/cdn/farfuture/x0dfr4CU7OI3M4D8FOO-SjMl5SIFwLaV9lZHQWlw1Q/mtime:1177095774/sites/default/files/manuals/pdf/150-287b.pdf>)

#### Notes

Manuale pentru semănători NO-Till End-wheel de 7-și 10-Foot se găsesc la [Vintage Drill Manuals](http://www.greatplainsag.com/en/manuals/917/vintage-drill-manuals) (<http://www.greatplainsag.com/en/manuals/917/vintage-drill-manuals>) > EWNT7 (<http://www.greatplainsag.com/en/manuals/917/vintage-drill-manuals#set-node-1398>).

#### Related Product Pages

The following are links to details and specifications for products that utilize this set of manuals: 706NT (</en/products/767/706nt>), 1006NT-Compact Drill (</en/products/771/1006nt-compact-drill>).

#### Field Adjustment Guides

706NT, 1006NT End Wheel No-Till Field Adjustment Guide ([http://www.greatplainsmfg.com/manuals/pdf/field\\_guides/FieldAdj-706NT\\_1006NT\\_EWNT\\_10-07.pdf](http://www.greatplainsmfg.com/manuals/pdf/field_guides/FieldAdj-706NT_1006NT_EWNT_10-07.pdf))

#### Other Support Documents

For general PDF service documents for Great Plains products, please visit our [Service Documents](#) (</node/363>) page in the [Support Center](#) (</node/852>) section.

## Customer Testimonials

**706NT: "Thanks for making such a great product!"** (</en/testimonials/9467/thanks-making-such-great-product>)

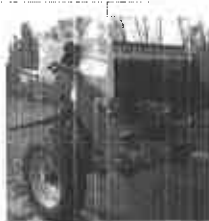

(</en/testimonials/9467/thanks-making-such-great-product>)

From Kevin B., Illinois:

"Our Soil & Water Conservation District here in Bureau County, Illinois, purchased our Great Plains No-Till Drill just over a year ago, and we are very pleased with it. Several local producers have used it to plant everything from grassed waterways, field borders, filter strips, and prairies full of native warm season grasses. Very easy to use and transport. Thanks for making such a great product!"

See the full testimonial... (</en/testimonials/9467/thanks-making-such-great-product>)

**Land Pride**

# Rotary Cutters

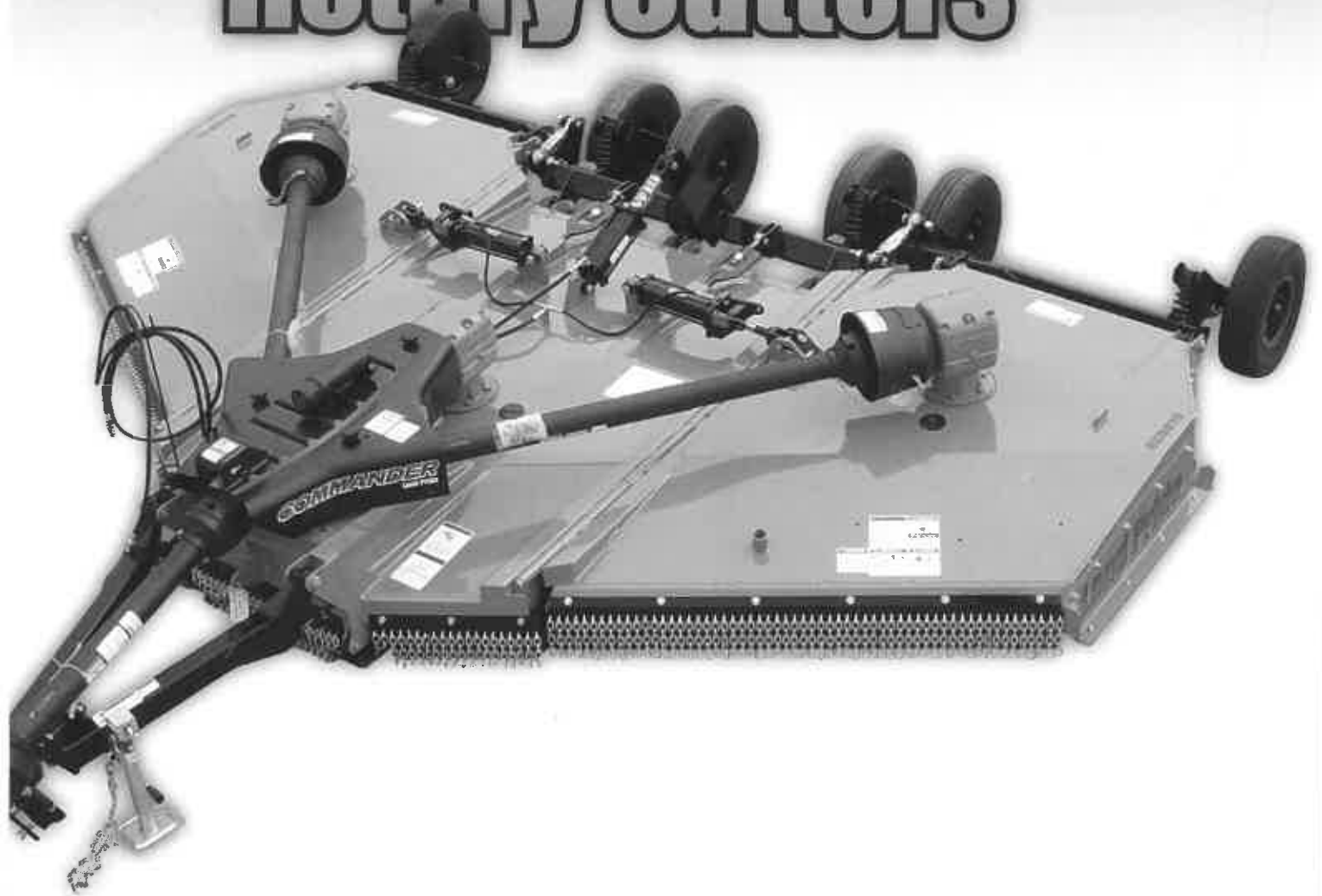

**Lp** Consistently Leading the Way...



<b>SINGLE SPINDLE</b>	<b>Page</b>
RCR12 Series	4
RCR15 Series	5
RCR18 Series	6
RCF20 Series	7
RCR26 Series	8
RCF27 Series	9
RCF36 Series	10
SC26 Series Skid Steer	11
<b>DUAL SPINDLE</b>	
RCD18 Series – Offset	12
RCR25 Series	13
RCF30 Series	14
RCF36 Series	15
<b>PARALLEL ARM HYDRAULIC</b>	
RCP26 Series	16
RCP30 Series	17
<b>FOLDING</b>	
12': RC25 Series	18
15': RC36 Series	20
15': RC40 Series	22
15': RC55 Series	26
15': RC56 Series	24
15': RC65 Series	29
15': RC66 Series	28
15': RCB66 Series	30
20': RC36 Series	34
20': RC50 Series	35
<b>OFFSET</b>	
10': RC55 Series	32
10': RC56 Series	32
10': RC65 Series	32
10': RC66 Series	32
14': RC36 Series	34
14': RC50 Series	33
<b>TESTING STANDARDS</b>	31

# Rotary Cutters

**Fast, clean, dependable mowing from Land Pride.**

With models up to 20' wide, Land Pride's full line of Rotary Cutters has the features and strength to tackle the toughest job. Our cutters offer fast, dependable mowing of grassy areas, pastures, and brush and have been extensively tested to ensure operating safety. Engineered for durability. Stronger gearboxes. Built like a brute. That's a Land Pride Rotary Cutter.

Our quality line up of Rotary Cutters feature top-quality steel, welding standards second to none, fist-tight quality controls, and gearboxes that we're so sure will last that we offer up to 7-year limited warranties on many cutters. They offer fast, clean, dependable mowing in a variety of applications.

From warranty to parts, we stand behind our products, too. When you need a replacement part, know that Land Pride is one of the best parts supplying companies in our industry.

Land Pride strongly recommends that front and rear shielding be used with any Rotary Cutter. Please understand how your cutter is to be equipped for you, as there are guarding options.

Many products are available in colors to match your tractor. See the legend next to the model throughout this catalog for color availability.

**Color Options:**



Land Pride Quick-Hitch Systems, available in a Cat. 1 and Cat. 2 Tractor 3-Point Hitch or Cat. 1 or 2 non-PTO Skid Steer Hitch, fit most Land Pride products and are a real time saver when working on multiple projects. Look for the Quick-Hitch System icon to denote applicable products.



Models may or may not include options. Design and specifications subject to change without notice. See dealer for complete warranty information.





**Ideal for clearing grass, weeds & light brush.**



	RCR1248	RCR1260	RCR1272
Horsepower	20-50 HP		
Hitch	Cat. 1 & Cat. 1 Limited		
Working Width (cm)	48" (122)	60" (152)	72" (183)
Overall Width	53-5/8"	64-1/4"	76-1/2"
Overall Length	89-1/8"	103-3/8"	114-1/2"
Weight - lb (kg)	400 (181)	478 (217)	564 (256)
Cutting Height	1-1/4" - 10"		
Cutting Capacity	1" Diameter		
Deck Thickness	12 Gauge		
Deck Height	7-1/4"		
Safety Guards	Front and Rear Rubber Guards		
Skids	1/4" x 2" Weld on		
Blades	1/2" x 3" Heat Treated Alloy Steel Free Swinging Blade		
Blade Tip Speed	13,256 fpm	16,536 fpm	15,033 fpm
Dishpan	Round 10 Ga. x 24" Diameter, Dish Shaped		
Gearbox	540 RPM, PTO Driven Gearbox, Cast Iron Housing		
Driveline	ASAE Cat. 3, Standard - 1/2" Shear Bolt Protection Optional - Bolt 2 Plate, Slip Clutch		
Tailwheel	15" Laminated Tire w/Cast Iron Hub		

See dealer for complete warranty information.

Color Options:



**In the City or the Country**  
Economically priced rotary cutter for daily use in small lots and country sides, capable of cutting 1" diameter material.

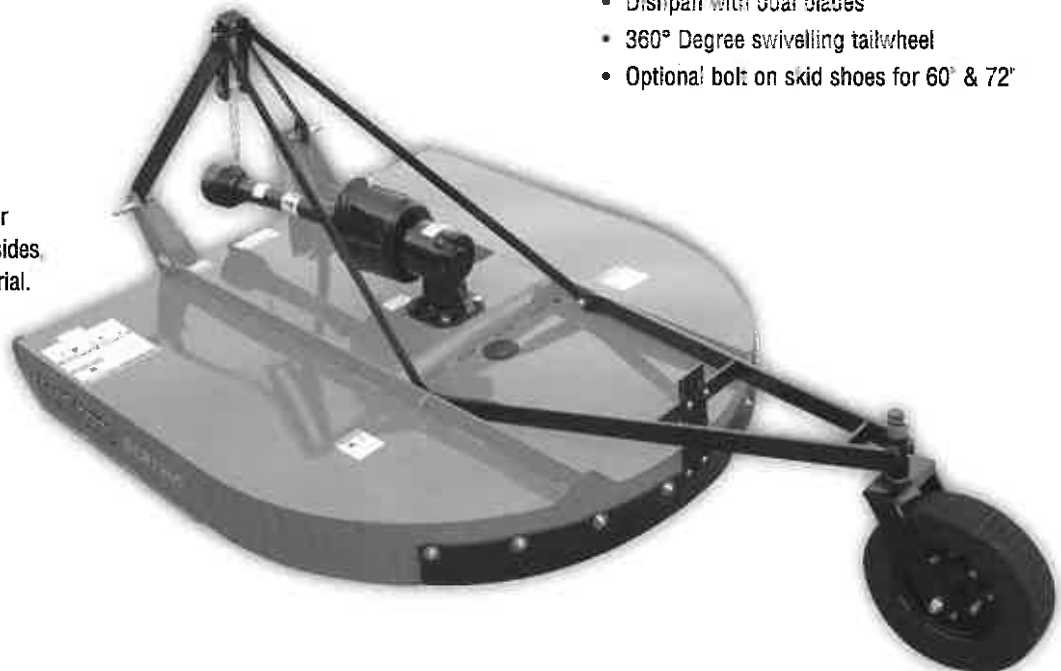

- Floating 3-point permits deck to hug the terrain
- Fully welded deck to side skirt
- Dishpan with dual blades
- 360° Degree swivelling tailwheel
- Optional bolt on skid shoes for 60" & 72"



**Efficient handling and  
dispersing of material.**



	RCR1542	RCR1548
Horsepower	20-50 HP	
Hitch	Cat. 1 & Cat. 1 Limited	
Working Width (cm)	42" (107)	45-1/2" (116)
Overall Width	47-1/2"	53-1/2"
Overall Length	85-1/4"	91-3/4"
Weight - lb (kg)	402 (182)	424 (192)
Cutting Height	1-3/4" - 11-1/2"	
Cutting Capacity	2" Diameter	
Deck Thickness	12 Gauge	
Deck Height	7-1/4"	
Safety Guards	Rubber Front and Rear	
Skids	1/4" x 2" Weld on	
Blades	1/2" x 3" Heat Treated Alloy Steel Free Swinging Blades	
Blade Tip Speed	11,459 fpm	13,090 fpm
Dishpan	Round 10 Ga. x 24" Dia., Dish Shaped	
Gearbox	540 RPM PTO Driven Gearbox Cast Iron Housing	
Driveline	ASAE Cat. 3, Standard - 1/2" Shear Bolt Protection Optional - Bolt 2 Plate Slip Clutch	
Tailwheel	4" x 16" Molded Rubber Tire	

See dealer for complete warranty information.



- Floating 3-point allows deck to hug the terrain
- 2 Position top link for greater lifting leverage on small tractors
- Shearpin or slip-clutch driveline
- High blade tip speed
- Driveline storage hook
- Fully welded deck adds additional strength





**Ideal for cleaning around the farm, the pond, or empty lots in the city.**



10 Gauge dishpan with 1" thick blade bar slides over stumps, rocks and debris.

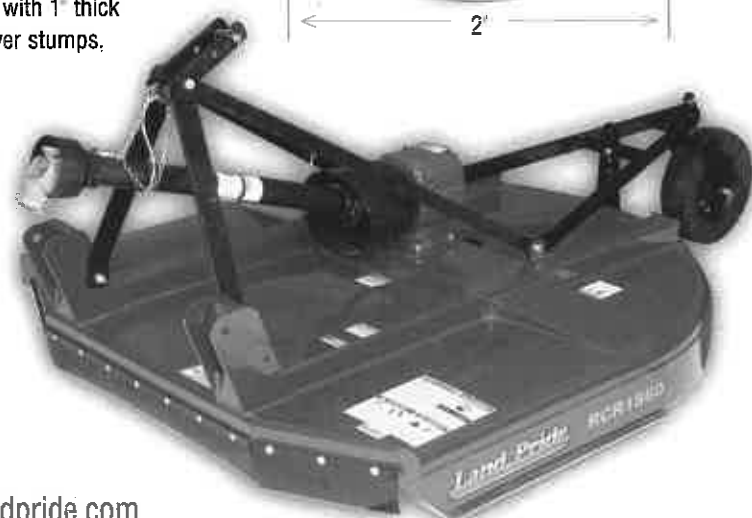

	RCR1880	RCR1872	RCR1884
Horsepower	20-85 HP		45-90 HP
Hitch	Cat. 1		
Working Width (cm)	57" (145)	69" (173)	84" (213)
Overall Width	65"	77"	89"
Overall Length	99-3/8"	110"	135"
Weight - lb (kg)	608	749	851
Cutting Height	1-1/2" - 13"	1-1/2" - 11-1/2"	2" - 11"
Cutting Capacity	2" Diameter		
Deck Thickness	11 Gauge	10 Gauge	
Deck Height	7-1/2"	9"	9-1/8"
Safety Guards	Rubber or Chain, Rear Metal Band - Standard		
Skids	1/4" x 2" Weld on		
Blades	Heat Treated Alloy Steel Free Swinging Blades		
	1/2" x 3"		1/2" x 4"
Blade Tip Speed	16,363 fpm	14,853 fpm	17,113 fpm
Dishpan	Round 10 Ga. x 24" Dia., Dish Shaped	Oval 10 Ga., Dish Shaped	
Gearbox	540 RPM, PTO Driven Gearbox		
Driveline	Standard - 1/2" Shear Bolt Protection Optional - Bolt 2 Plate Slip Clutch		
	ASAE Cat. 3		ASAE Cat. 4
Tailwheel	4" x 16" Solid Rubber Tire, Cast Iron Hub		4" x 8" x 15" Laminated Tire or Dual Laminated Optional, Cast Iron Hub

See dealer for complete warranty information.

Color Options:



- Floating 3-point allows deck to hug the terrain
- Fully welded deck adds additional strength
- High blade tip speed ensures clean cut
- Single or dual tailwheel on 84"
- Heavy-duty tailwheel spindle
- Rubber or chain guards protect against flying debris
- All-welded formed channels front to rear add superior strength
- Lower clevises for easy hookup

# The Perfect Cutter for Rural Grass Maintenance - in a Smooth Top Design.

- Smooth top for easier cleaning
- Floating top link for following ground undulations
- ASAE Category 3 driveline
- Fully welded deck
- Available rubber or chain guards - front and rear
- High blade tip speed
- 84" Features single or dual tailwheel option

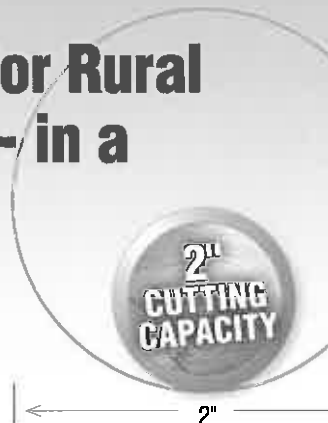

	RCF2060	RCF2072	RCF2084
<b>Horsepower</b>	20-65 HP		45-90 HP
<b>Hitch</b>	Cat. 1 - Floating Top Link		Cat. 1 & 2 Floating Top Link
	Clevis Type Lower Links, Quick Hitch Adaptable		
<b>Working Width (cm)</b>	60 (152)	72 (183)	84 (213)
<b>Weight - lb (kg)</b>	590 (268)	712 (323)	915 (415)
<b>Cutting Height</b>	1-1/2" - 12"		
<b>Cutting Capacity</b>	2"		
<b>Deck</b>	All Welded		
<b>Deck Thickness</b>	10 Gauge		
<b>Deck Height</b>	9-11/16"	11"	11-15/16"
<b>Safety Guards</b>	Rear Metal Banding - Standard		
<b>Optional Guarding</b>	Front: Rubber or Chain Rear: Rubber or Chain		
<b>Skids</b>	Weld-on (Bolt on Accessory Skid Shoes Available)		
<b>Blades</b>	2 ea. (1/2" x 3" Heat Treated) Free Swinging High-Lift		2 ea. (1/2" x 4" Heat Treated) Free Swinging High-Lift
<b>Blade Bolt</b>	Keyed w/Hardened Flat Washer & Lock Nut		
<b>Blade Speed</b>	16,363 fpm	14,955 fpm	17,113 fpm
<b>Dishpan</b>	Round, 10 Ga x 24" Dia. Dish Shaped		Oval, 3/16" x 27"
<b>Gearbox Rating</b>	65 HP	65 HP	90 HP
<b>Gearbox</b>	540 RPM, Beveled Gears, Cast Iron Housing		
<b>Driveline</b>	ASAE Cat. 3, Shear Bolt or 2-Plate Slip-Clutch		ASAE Cat. 4; 2-Plate Slip-Clutch
<b>Tailwheels</b>	4" x 15" Laminated Tire or 4" x 16" Molded Rubber - 360 Degree Swivel		Single or Dual 4" x 15" Laminated Tire w/ Cast Iron Hub - 360 Degree Swivel

See dealer for complete warranty information.



## Roundback design allows for more efficient handling and dispersing of material.

Land Pride's 26 Series Rotary Cutters are the perfect fit for around the farm clean-up or keeping the horse pasture under control. The 3" cutting capacity also allows it to be the choice of many municipalities from parks to easement control applications.

The floating top link allows the cutter to follow uneven terrain. The beefy lower hitch clevises allow easy hook-up to the tractor, as well as adding another degree of strength to the overall hitch area.

Take a close look at our welding, and the precise fit-up of all the fabricated parts and you'll understand the perfection we expect out of our manufacturing facilities. Our cast iron gearbox has internal components crafted to a precision fit; teeth and gears that mesh together perfectly for a quiet and efficient power source.

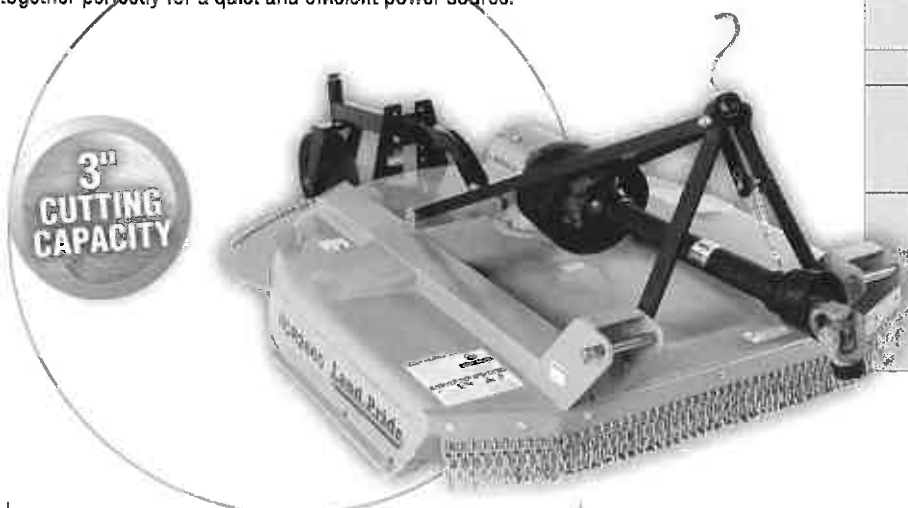

	RCR2660	RCR2672	RCR2684
Horsepower	40-130 HP		60-130 HP
Hitch	Cat. 1 & 2		Cat. 2 & 3
Working Width (cm)	60' (154)	72' (183)	84' (213)
Overall Width	67'	79'	90-3/4'
Overall Length	114'	126'	Single 135' Dual 116'
Weight - lb (kg)	1002 (454)	1046 (474)	1370 (621) Single ga. w/ 1500 (680) Dual ga. w/
Deck Thickness	10 Gauge		
Cutting Height	2'-12"		
Cutting Capacity	3" Diameter		
Safety Guards	Front and Rear: Chain		
Skids	Full Length Weld & Replaceable Shoes		
Deck Height	9-1/8"	10-1/8"	
Blades	1/2" x 4" Heat Treated Alloy Steel Free Swinging Blades		
Blade Tip Speed	12,384 fpm	14,861 fpm	14,369 fpm
Dishpan	3/16" x 24" Round, Dish Shaped	3/16" x 30-1/2" Round, Dish Shaped	3/16" x 24" 38" Oval, Dish Shaped
Gearbox	540 RPM PTO Driven, 1-3/8" 6 Spline Cast Iron Housing		
Driveline	ASAE Cat. 4 4-Plate Slip Clutch		
Tailwheel	4" x 8" x 15" Laminated Tire Cast Iron Hub		

See dealer for complete warranty information.

Color Options:



- Replaceable skid shoes
- Clevis hitch for easy hook-up
- Full length skids with replaceable shoes
- Rugged laminated tailwheel
- Fully welded deck
- 3-Point with dual 15" tailwheels on 84"



3/16" Dishpan with 1" x 4" blade bar provides superior strength for encountering objects in the blade path. Round on 60" & 72"; oval on 84"

## Roundback with a Smooth Top

The roundback design of our popular 26 Series medium-duty cutter is now available in a smooth top. The RCF27 Series also features a floating top link to help follow the contour of the ground.



	RCF2760	RCF2772	RCF2784
Horsepower	40-130 HP		60-130 HP
Hitch	Cat. 1 & 2		Cat. 2 & 3, Pull-Type
Working Width	60" (152)	72" (183)	84" (213)
Weight - lb (kg)	955 (433)	1072 (486)	1354 (614), Pull-Type: 1632 (740)
Cutting Height	1-1/2" - 12"		
Cutting Capacity	3"		
Deck	All Welded, Smooth Top		
Deck Thickness	10 Gauge		
Deck Height	11-1/4"	10-1/8"	
Side Thickness	1/4"		
Safety Guards	Front: Chain or Rubber, Rear: Chain		
Skids	Replaceable		
Blades	Free Swinging High Suction, 1/2" x 4" - Heat Treated		
Blade Bolt	Keyed with Hardened, Flat Washer & Lock Nut		
Blade Tip Speed	12,384 fpm	14,861 fpm	14,369 fpm
Dishpan	3/16" x 24" Round, Dish Shaped	3/16" x 30-1/2" Round, Dish Shaped	3/16" x 24" x 38" Oval, Dish Shaped
Gearbox	540 RPM, 130 HP 1-3/8" - 6 Spline		
Gearbox Output Shaft	2"		
Driveline	ASAE Cat. 4 with 4 Plate Slip-Clutch		
Tailwheel(s)	15" Laminated, w/Cast Iron Hub, Tapered Roller Bearings		

See dealer for complete warranty information.



- Replaceable skid shoes
- Smooth top design
- All welded deck
- Clevis style lower hitch
- Reinforced rear chain guard
- Floating top hitch
- Pull-type model available in 84" model
- Dual wheels optional on 3-point 84" model, Standard on Pull-Type



## Our RCF36 Series Rotary Cutter is a Brute!

This cutter features a 190 HP gearbox capable of cutting heavy grass and weeds, row crop stubble, thick brush, and small trees up to 4' in diameter.



	RCF3660	RCF3672	RCF3684
Horsepower	50-190 HP	80-190 HP	Lift: 70-190 HP Pull: 50-190 HP
Hitch	Cat. 1 & 2		Cat. 2 & 3, Pull-Type
Working Width (cm)	60" (152)	72" (183)	84" (213)
Overall Width	66-1/2"	78-1/2"	90-1/2"
Overall Length	112-1/2"	124-3/4"	133", 179-1/2" Pull
Weight - lb (kg)	1233 (559)	1337 (606)	2000 (907), Pull-type 2104 (954)
Cutting Height	2' - 12'		
Cutting Capacity	4'		
Deck	All Welded, Smooth Top		
Deck Thickness	3/16"		
Deck Height	13-3/8"		
Side Thickness	1/4"		
Safety Guards (Choose)	Front: Rubber, Sgl or Dbl Chains, Rear: Sgl or Dbl Chains or Band		
Skids	Replaceable		
Blades	Free Swinging High Lift, 1/2" x 4", Heat Treated Steel		
Blade Bolt	Keyed with Hardened, Flat Washer & Lock Nut		
Blade Tip Speed	13,572 fpm	14,861 fpm	14,369 fpm
Dishpan	3/16" x 30-7/16" Round, Dish Shaped		
Gearbox	540 RPM, 190 HP, 1-3/4" - 20 Spline		
Gearbox Output Shaft	2-3/8"		
Driveline	ASAE Cat. 5 with 4 Plate Slip-Clutch		
Tailwheel(s)	15" Laminated, w/Cast Iron Hub, Tapered Roller Bearings, 21" on Pull-type		

See dealer for complete warranty information.

Color Options:



- Replaceable skid shoes
- Smooth top design
- All welded deck
- Reinforced rear chain guard
- Heavy-duty tailwheel mount
- Floating top hitch
- Pull-type available in 84" model
- Optional Shredder Kit makes quick work of prunings and crop residue.





## Expand the versatility of your skid steer or track loader.

The SC26 Skid Steer Cutter has an eye pleasing smooth top design for easy maintenance and clean running. Attachment is made quick and easy with the standard universal skid steer floating-hitch mounting plate. The float capability makes operation very user friendly over uneven ground.

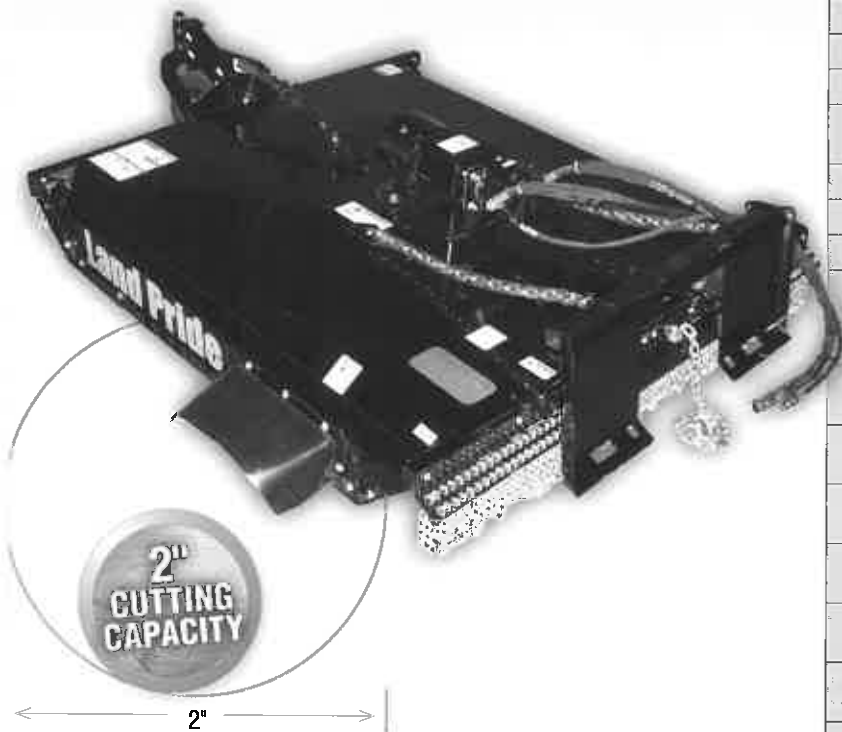

	SC2660	SC2672
Hitch	Skid Steer Mounting Plate	
Working Width (cm)	60" (152)	72" (183)
Overall Width	65-1/2"	78"
Overall Length	73"	91"
Weight - lb (kg)	1,004 (455)	1,256 (570)
Cutting Height	1.5" to 18" Infinitely Variable	
Cutting Capacity	2" Diameter	
Blade Rotation	Clockwise	
Blades	1/2" x 4" Updraft, Heavy Duty	
Dishpan	3/16" x 32", Round	
Double Deck Design Construction	Lower Deck: 10 Gauge; Upper Deck: 14 Gauge	
Side Skirt Construction	1/4" Steel	
Safety Guards	Front & Rear Chain	
Deck Lift Ht. Protection	Safety Chain Limiter	
Deck Wear Protection - Optional	Four Corner Mounted Skid Shoes - Standard or Heavy	
Operator Protection	Protective Door Shield	
Gauge Wheel Option	Pivoting & Adjustable Front Mounted Gauge Wheel w/Laminated Tire	
16 GPM Volume Drive Motor (60" Only)	For hyd. systems with 11-16 GPM flow at 1500-3000 PSI, 88 ft. lbs. torque at 2500 PSI	
21 GPM Volume Drive Motor	For hyd. systems with 17-21 GPM flow at 1500-3000 PSI; 117 ft. lbs. torque at 2500 PSI	
27 GPM Volume Drive Motor	For hyd. systems with 22-27 GPM flow at 1500-3000 PSI, 152 ft. lbs. at 2500 PSI	
16 GPM Volume Motor Max Blade Tip Speed	18,540 FPM	N/A
21 GPM Volume Motor Max Blade Tip Speed	18,850 FPM	17,200 FPM
27 GPM Volume Motor Max Blade Tip Speed	19,000 FPM	18,550 FPM



See dealer for complete warranty information.

Color: 



- Optional front-mounted pivoting gauge wheel w/laminated tire
- 3 GPM volume motors to choose from
- Operator protection door available for skid steer units without doors
- Mounting plate can be centered or offset to right
- Case drain required



## Right for the Job.

The RCD1884 Rotary Cutter offers a smooth deck for easy cleaning, shorter in length than single spindle cutters to help you maneuver tight spaces, as well as being ideal in orchard-type applications.

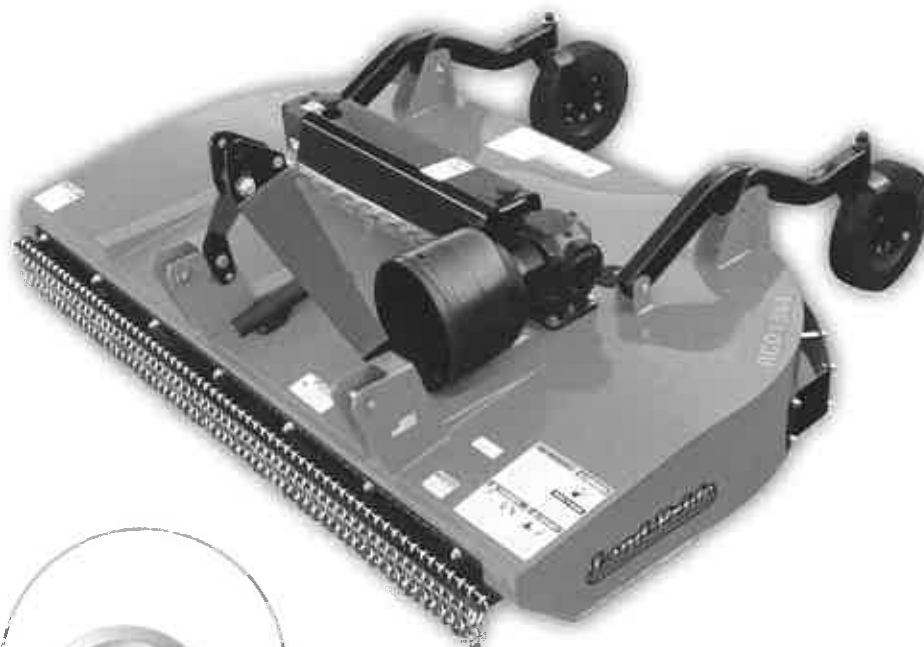
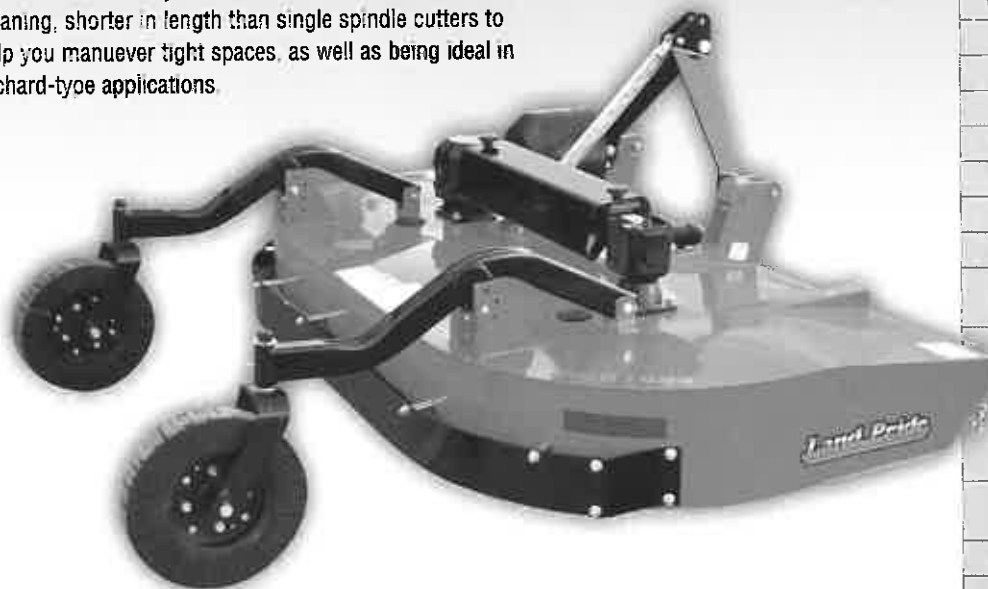

	RCD18
Horsepower	35-60 HP
Hitch	Cat. 1 QH
Working Width (cm)	84" (213)
Weight - lb (kg)	839 (381)
Cutting Height	2'-12"
Cutting Capacity	1-1/2"
Offset	10"
Deck	All Welded
Deck Thickness	10 Gauge
Deck Height	11-5/8"
Safety Guards	Front: Rubber or Chain Rear: Metal Band
Skids	Weld-on
Additional Skids	Bolt-on
Blades	2 Each, 1/2" x 4" Heat Treated Free Swinging Alloy Steel Suction Blades
Blade Bolt	Keyed with Hardened Flat Washer & Lock Nut
Blade Speed	11,693 fpm
Dishpan	10 Ga. x 24", Round, Dish Shaped
Gearbox	540 RPM, 60 HP Main, 45 HP Side, Beveled Gears, Cast Iron Housing
DriveLine	Cat. 3 with 2-Plate Slip-Clutch
Tailwheels	15" Laminated Tire or 4" x 16" Molded Rubber

See dealer for complete warranty information.

Color Options:



- Deep deck design
- All welded deck
- Short coupled for tight spaces
- Clevis style hitches
- Offset to cover your tractor tire and get closer to obstructions

1-1/2"  
CUTTING  
CAPACITY

1-1/2"

## A perfect fit for any size farm.

The RCR25 Series is just perfect for those medium sized chores. Designed for performance in pastures, set aside acres, roadsides, and routine farm maintenance.

**Pull-type** — The Pull-type model features two leveling rods that connect the rear axle to the front tongue. This enables the deck to stay level over uneven ground conditions. The height controlling axle cylinder is attached to two deck springs that help cushion the cutter in rough terrain.

**3-Point** — The 3-point unit utilizes two castering laminated tailwheels for smooth, trouble-free performance. The easy to attach clevis hitch is designed to fit Cat. 1 or 2 tractors on the 96" model, and Cat. 2 or 3 tractors on the 10' model.



Narrow tongue on pull-type allows for tight turns.

	RCR2596	RCR2510
<b>Horsepower</b>	Pull: 40-110 HP 3-Pt: 50-110 HP	Pull: 50-110 HP 3-Pt: 60-110 HP
<b>Hitch</b>	Cat. 1 & 2	Cat. 2 & 3
<b>Working Width (cm)</b>	7'10" (239)	9'10" (300)
<b>Overall Width</b>	8'3-3/4"	10'3-1/2"
<b>Overall Length</b>	Lift - 8'10", Pull - 11'8-3/4"	Lift - 9'4", Pull - 12'6"
<b>Weight - lb (kg)</b>	3-Pt: 1,380 (625) Pull: 1,665 (755)	3-Pt: 1,750 (793) Pull: 2,035 (923)
<b>Deck Material Thickness</b>	10 Gauge	
<b>Deck Height</b>	9-5/8"	
<b>*Safety Guards (choose)</b>	Front or Rear Chain / Front or Rear Rubber	
<b>Skids</b>	Replaceable	
<b>Gearbox</b>	540 rpm or 1000 rpm, Cast Iron Housing, Beveled Gears	
<b>Cutting Height</b>	2" - 12"	2" - 10-1/2"
<b>Cutting Capacity</b>	1-1/2"	
<b>Blades</b>	1/2" x 4" Heat Treated, Free-Swinging Suction Blades	
<b>Blade Tip Speed</b>	540 RPM: 14,592 fpm	540 RPM: 17,749 fpm 1000 RPM: 18,035 fpm
<b>Dishpan</b>	3/16", Round, Dish Shaped	
<b>Driveline</b>	540 rpm - ASAE 4 Plate Slip-Clutch 1000 rpm - ASAE 2 Plate Slip-Clutch	
<b>Tailwheel</b>	Lift-Type: 2 each, 4" x 8" x 15-1/4" Laminated Pull-Type: 2 each, 6" x 9" x 21" Laminated or 24" Aircraft Tires	

See dealer for complete warranty information.



- Slip-clutch and impact absorbing cross shafts to outer gearboxes
- Constant Velocity U-Joint option on 10' Pull-type
- Slip-clutch protection on main driveline
- Fully welded 10 Gauge deck
- Round back design
- Chain or rubber shield option
- Full length skids with replaceable shoes
- 1" x 4" Blade bar





## Performance in a Medium-Duty Cutter.

The RCF30 Series is the perfect medium-duty cutter for pastures and roadside applications. Available in 3-point semi-mount or pull-type, the RCF30 features a 2-1/2' cutting capacity and 1/4' side skirts. Plus, every RCF30 comes with the rugged dependability that Land Pride Rotary Cutters are known for.



**Semi-Mount with Heavy-Duty Toolbar Axle**

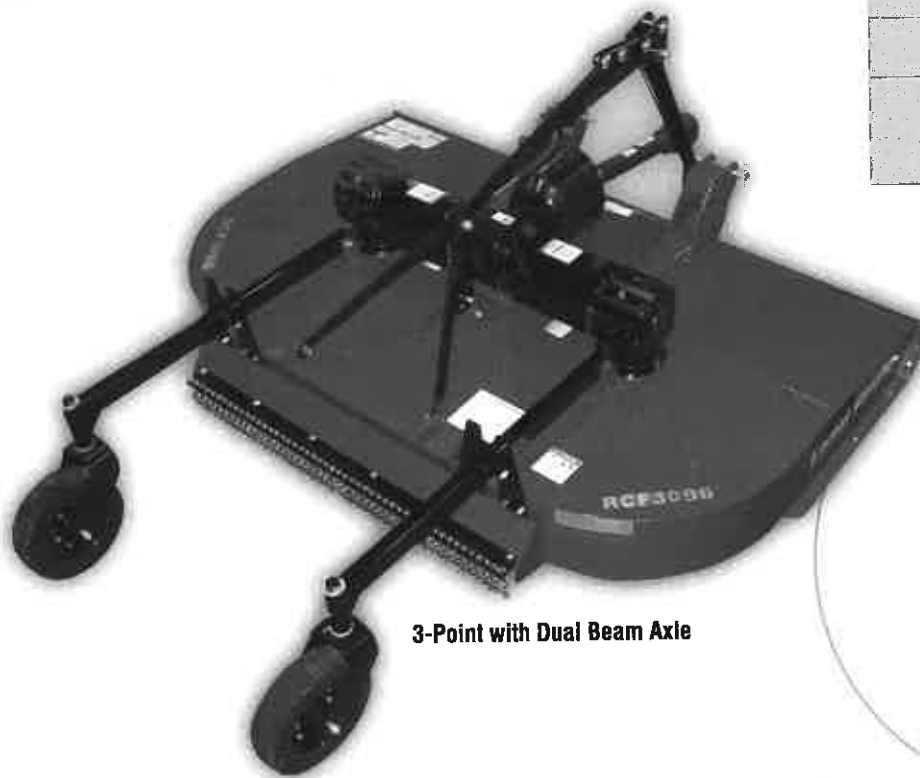

**3-Point with Dual Beam Axle**

	RCF3010	
Horsepower	3-Pt. 50-110 HP Semi & Pull: 40-110 HP	3-Pt. 60-110 HP Semi & Pull: 50-110 HP
Hitch	Cat. 1 & 2 QH	Cat. 2 & 3 QH
Working Width (cm)	8' (244)	10' (305)
Overall Width	8'7"	10'6-1/2"
Overall Length (3-Pt. w/Twin Beam Axle)	102"	122"
Weight - lb (kg) (3-Pt. w/Twin Beam Axle)	1,587 (720)	2,004 (909)
Blade Tip Speed	16,360 fpm	540: 17,100 FPM; 1000: 17,300 fpm
Deck Material Thickness	10 Gauge	
Side Skirt Thickness	1/4"	
Gearbox	540 RPM	540 RPM or 1,000 RPM
Gearbox Rating	Outboard: 110 HP, Carter 160 HP	
Cutting Height	2" - 12"	
Cutting Capacity	2-1/2" Diameter	
Shielding	Front: Rubber, Chain or Double Chain Rear: Rubber, Chain or Double Chain	
Skids	Replaceable	
Deck Height	11-1/4"	11-1/2"
Blades	1/2" x 4" Heat Treated Alloy Steel Free Swinging Blades	
Dishpan	3/16" Round, Dish Shaped	
Driveline	3-Point & Semi-Mount: ASAE Cat. 4 Pull-type: ASAE Cat. 4 Equal Angle or C	
Driveline Protection	Slip-Clutch and Impact Absorbing Cross Shafts to Outer Gearboxes	
Tires	3-Point: 15" or 21" Laminated Pull-Type: 21" Laminated, 24.5" Foam Filled, or 29" Aircraft Semi-Mount: 15" or 21" Laminated	

See dealer for complete warranty information.

Color Options:



2-1/2'

# Bigger and Better.

Building on the success of the RCR35 Series, Land Pride is proud to offer the RCF36 Dual-Spindle Rotary Cutter – an updated, heavy-duty, flat-top version of the original RCR35. With larger gear boxes, larger cutting capacity, and a deeper deck, the RCF36 is the ideal dual-spindle cutter for narrow areas in pastures, along roadsides, or in tree groves.



**Semi-Mount**

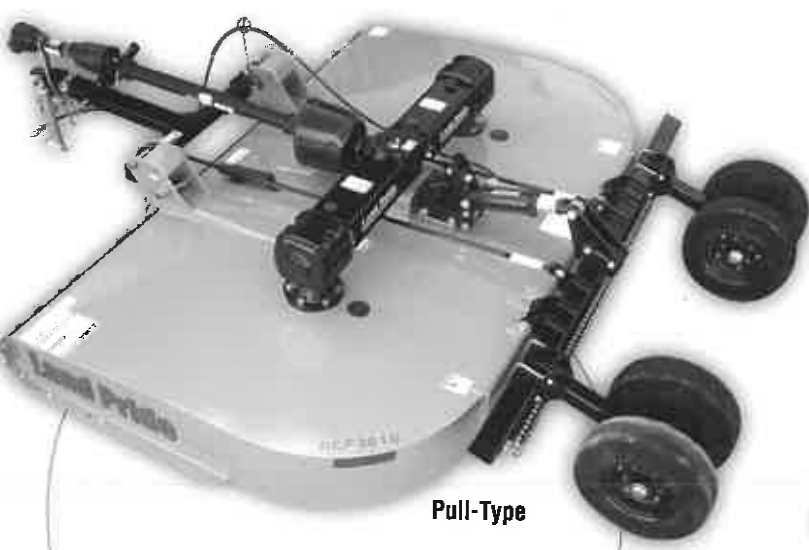

**Pull-Type**

**3" CUTTING CAPACITY**

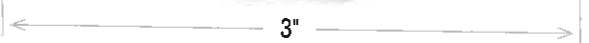

	RCF3606	RCF3610
<b>Horsepower</b>	3-Pt: 50-120 HP Semi & Pull: 40-120 HP	3-Pt: 60-120 HP Semi & Pull: 50-120 HP
<b>Hitch</b>	Cat. 1 & 2 QH	Cat 2 & 3 QH
<b>Working Width (cm)</b>	8' (244)	10' (305)
<b>Overall Width</b>	8'7"	10'6-1/2"
<b>Overall Length (3-Pt w/Rigid Axle &amp; Chains)</b>	8'10"	10'2"
<b>Weight - lb (kg) (3-Pt w/Rigid Axle &amp; Chains)</b>	1,838 (834)	2,310 (1048)
<b>Cutting Height</b>	2" - 12"	
<b>Cutting Capacity</b>	3" Diameter	
<b>Deck Thickness</b>	10 Gauge	
<b>Deck Height</b>	13"	
<b>Side Thickness</b>	1/4"	
<b>Safety Guards (Choose)</b>	Front: Rubber, Chain or Double Chain Rear: Rubber, Chain or Double Chain	
<b>Skids</b>	Replaceable	
<b>Blades</b>	1/2" x 4" Heat Treated Alloy Steel Free Swinging Blades	
<b>Blade Tip Speed</b>	540: 17,100 fpm; 1000: 17,400 fpm	540: 17,100 fpm; 1000: 17,400 fpm
<b>Dishpan</b>	3/16" Round, Dish Shaped	
<b>Gearbox</b>	540 RPM or 1,000 RPM	
<b>Gearbox Rating</b>	Outboard: 205 HP, Center 210 HP	
<b>Driveline</b>	3-Point & Semi-Mount: ASAE Cat. 4 Pull-Type: ASAE Cat. 4 Equal Angle or CV	
<b>Driveline Protection</b>	Slip-Clutch and Impact Absorbing Cross Shafts to Outer Gearboxes	
<b>Tires</b>	3-Point & Semi-Mount: 15" or 21" Laminated Pull-Type: 21" Laminated, 24" Foam Filled or 29" Aircraft	

See dealer for complete warranty information.



**3-Point**



# Hydraulic Driven Parallel Arm Rotary Cutter.

Designed to "reach out" and cut along roadsides, over guard rails, down ditchbanks, and along side ponds. Land Pride's Parallel Arm Rotary Cutter has features not found on your typical boom cutter.

First of all, it has a constant attitude! When the two cylinders that operate the two arm sections are activated, the attitude of the deck does not change; thanks to the parallel arm design. Lift the cutter head up, in or out to negotiate an obstacle, and your cutter deck position does not change; set the cutter head down at the same attitude as it was prior to the obstacle. This makes your work efficient!

The hydraulic breakaway feature of the RCP is also not found on your standard boom cutter. The cutter deck is restored to its original position with the help of a hydraulic cylinder. The cutter deck can also swing rearward enabling you to mow into a tight corner, again putting it back to its original setting with the hydraulic cylinder.

The cutter deck is operated by a hydraulic motor, which is run by a pump powered by the PTO of the tractor utilizing the tractor hydraulics, or an optional self contained system. A flow control valve is standard equipment to protect the hydraulic system of the cutter from the high GPM many of the newer tractors now utilize. The 35 gallon oil reservoir keeps the unit running cool, and the in-line filter continually cleans the oil each time it is returned to the reservoir.

The optional electronic package enables each of the arm and deck hydraulic cylinders to be activated by a toggle switch. You get instant response from the cylinder, which can be very difficult with the tractor's hydraulic controls.

Moving this cutter up and around obstacles, in and out next to water or roadsides is what this cutter is all about. Save time and work efficiently with the boom mower that does more!



Optional gauge wheel deck allows the cutter to float over undulations without having to constantly monitor terrain conditions.

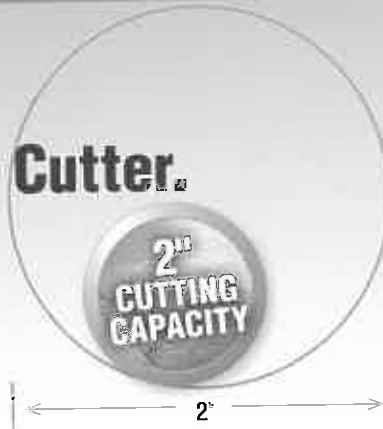

RCP2580	
Horsepower	75-150 HP
Hitch	Cat. 2 & 3
Working Width (cm)	58" (147)
Min. Transport Width	10'1"
Min. Tractor Weight - lb (kg)	8000 (3629)
Tractor Hydraulics Req'd	Max 4, Min 1
Hydraulic Pump Input	540 RPM or 1000 RPM
Hyd. Oil Capacity	35 Gallons
Hydraulic Oil Flow	15 GPM
Hydraulic System	Tractor Provided or Self Contained
Overload Protection	Relief Valve
Oil Cleansing	Return Line Filter, Replaceable
Oil Check	Dipstick
Min. Cutting Height	2"
Cutting Capacity	2" Diameter
Horiz. Cutting Reach	15'6" Maximum
Vertical Cutting Reach	11'5" Maximum
Below Ground Level Reach	9'1" Maximum
Operating Tilt Arc	180 Degrees
Deck Thickness	10 Gauge
Safety Guards	Front and Rear Chain Guards
Blades	2 Each, 1/2" x 4"
Blade Bolt	Keyed with Hardened Flatwasher & Lock Nut
Blade Tip Speed	15,000 FPM
Blade Rotation	Clockwise
Dishpan	3/16" x 21" Round, Dish Shaped
Driveline	Cat. 2
Storage	2 Parking Stands
Unit Protection	Tension Bolt and Hydraulic Breakaway Cylinder
Options	Operator Shield Suitcase Weight Bracket Gauge Wheels

Color: 



In-line filter cleans hydraulic fluid before it re-enters reservoir.

## 3 Foot longer reach than the RCP26 Series.



Great for those roadsides that want a manicured look further down the ditch, or being able to stay a little further away from the soggy banks of the pond.

### TOP QUALITY FEATURES ON RCP26 AND RCP30



Hydraulic breakaway feature pivots arm backward to avoid obstacles and protect cutter arm. Hydraulically pivots back into place.



Low control valve compensates for various hydraulic systems.

Shut-off valve permits maintenance without oil loss.

The built in weight rack can be ordered to fit with various suitcase weight styles.



Grease zerks at all pivot points.

Optional Self-contained hydraulics.

Electronic cylinder controls provide instant response for adjustments on the go.

	RCP3060
Horsepower	95-175 HP
Hitch	Cat. 2 & 3
Working Width (cm)	58" (147)
Min. Transport Width	10'1"
Min Tractor Weight - lb (kg)	12,000 (5443)
Tractor Hydraulics Req'd	Max 4, Min 1
Hydraulic Pump Input	540 RPM or 1000 RPM
Hyd. Oil Capacity	35 Gallons
Hydraulic Oil Flow	15 GPM
Hydraulic System	Tractor Provided or Self Contained
Overload Protection	Relief Valve
Oil Cleansing	Return Line Filter, Replaceable
Oil Check	Dipstick
Min. Cutting Height	2"
Cutting Capacity	2" Diameter
Horiz. Cutting Reach	18'10" Maximum
Vertical Cutting Reach	13'5" Maximum
Below Ground Level Reach	11" Maximum
Operating Tilt Arc	180 Degrees
Deck Thickness	Front and Rear Chain Guards
Safety Guards	10 Gauge
Blades	2 Each 1/2" x 4"
Blade Bolt	Keyed with Hardened Flatwasher & Lock Nut
Blade Tip Speed	15,000 FPM
Blade Rotation	Clockwise
Dishpan	3/16" x 21" Round, Dish Shaped
Driveline	Cat. 2, 1 3/8" 21 Spline
Storage	2 Parking Stands
Unit Protection	Tension Bolt and Hydraulic Breakaway Cylinder
Options	Operator Shield Suitcase Wt. Bracket (Required) Gauge Wheels

Additional tractor weight (dual tractor wheel, calcium, etc.) may be needed.

Color:



- Hydraulic break away and reset
- Case drain deck motor
- Gauge wheel package allows unit to follow ground contour while operating in float position





## Mow Like the Big Boys!

Designed with smaller tractors and smaller areas to cut in mind, our 12' Rotary Cutter has a lot of the features found in our larger folding cutters. The 12' width, sharp turning radius and low tongue weight makes this an ideal rotary cutter for compact tractor owners.

# RANGER



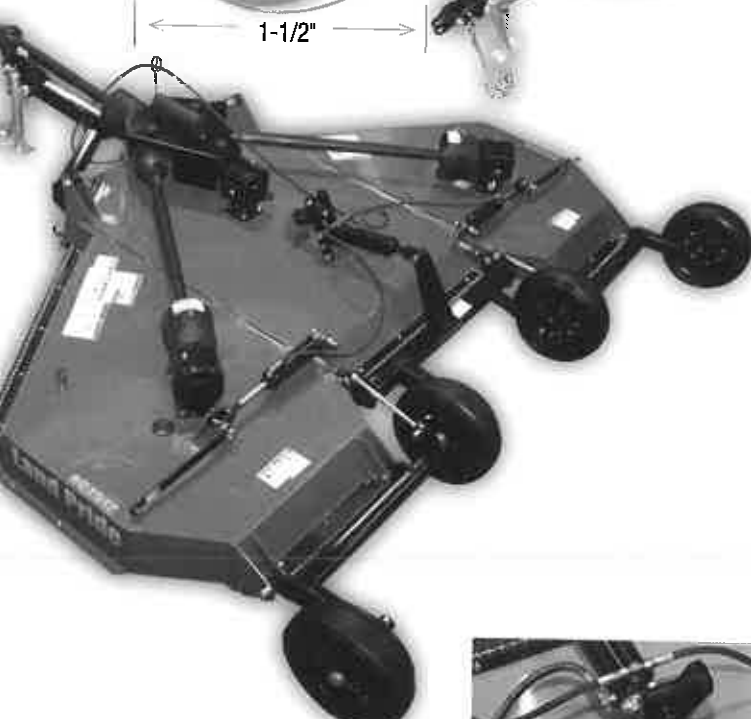

1-1/2"

	RC2512
Horsepower	40-75 HP
Hitch	Pull-Type, Self Leveling Hitch & Clevis
Working Width (cm)	12' (366)
Min. Transport Width	7'11"
Overall Width	12'7"
Overall Length	13'3"
Machine Weight - lb (kg)	2,540 (1152)
Tongue Weight - lb	793
Cutting Height	1-1/2" - 12"
Cutting Capacity	1-1/2"
Deck Thickness	10 Gauge
Deck Height	11"
Deck Shock Protection	Spring Cushioned Center Axle
Side Skirt Thickness	3/16" Plate
Safety Guards	Front and Rear Chain - Std
Skid Shoes	Wings & Center, Replaceable
Blades	2 per Section, 1/2" x 3" Heat Treated Free Swinging Alloy Steel w/Uplift
Blade Bolt	Keyed with Hardened Flatwasher & Lock Nut
Blade Overlap	6"
Blade Speed	Center: 16,500 fpm, Wings: 16,000 fpm
Dishpan	10 Gauge, Round, Dish Shaped with 1" x 3-1/2" Blade Bar
Wing Cutting Angle	22 Deg. Down, 45 Deg. Up
Wing Transport Locks	Standard
Wing Hydraulics	2" x 8" Cylinder, Hoses & Fittings
Height Adjustments	2-1/2" x 8" Cylinder, Hose, Fittings & Stroke Control Spacers
Gearbox	540 rpm: 160 HP Divider, 75 HP Center & Wings
Gearbox Input Shaft	1-3/8" 6 Spline
Gearbox Output Shaft	1-1/2"
Input Driveline	Constant Velocity U-Joint, Cat. 4
Connecting Driveline	Cat. 3 Slip-Clutch
Wheels (4)	21" Laminated Tires 20.5" Aircraft Tires Tapered Roller Bearings & Cast Iron 5-Bolt Hubs with 1-3/4" Shaft

See dealer for complete warranty information.



- Center spring-cushioned axle
- Great size for country estates
- Dual hinge rods for levelling
- Narrow tongue design for tight turns



The center spring holds just the right tension to absorb rough terrains, giving you a smoother pull through the field.



# Plainsman

**Give your pasture that  
well-groomed look!**

Taking proper care of pasture ground plays an important role in maintaining the agricultural and country side landscape in any area.

If you are maintaining grazing areas for your horses or mowing the wide open spaces close to town, our 36 Series Plainsman leaves a cut you'll be proud of.

With constant compliments that our 36 series cutter cuts like a grooming mower, we too have to remind ourselves that this cutter is still built like a brute. Starting with precision built gearboxes rated up to 160 HP with a 2" output shaft, a Cat. 5 main driveline, and a strategically designed 10 gauge deck, this cutter likes to run with the big boys!

2-1/2"  
CUTTING  
CAPACITY

2-1/2'



Deck Rings Available!



With a choice of tires from and chain or rubber guards, you can outfit this cutter to suit your needs. If you transport your cutter from field to field, the airplane tires will give you a smoother ride. If you are cutting over rough material, you should probably choose the chain guards. Whatever the situation, our workmanship and integrity will be in the field with you!

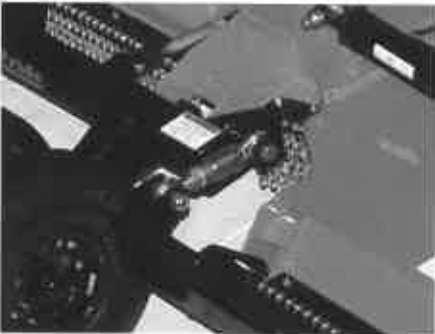

The heavy-duty turnbuckle keeps the center and wing axles at the same cutting height. With grease fittings incorporated in the turnbuckle, free motion is maintained for quality performance.



Choice of aircraft tires w/wo foam or laminated tires.

The 1" thick, 4" wide reinforcement aids the dishpan in withstanding the constant punishment the overall drivetrain must endure.



Hitches Available on all 36 Series and above Folding Cutters



**Standard Clevis Hitch**  
Pivots up and down on uneven terrain



**Double Swivel Clevis Hitch**  
Swivels up and down and side to side



**Bar-tite™ Clevis Hitch**  
Bolts tight to drawbar which eliminates drawbar wear. Swivels up and down, and rotates on greaseable shaft

RC3675 MEDIUM DUTY	
Horsepower	50-160 HP
Hitch	Standard Clevis, Swivel, Pintle or Bar-Tite Hitch
Working Width (cm)	15' (457)
Overall Width	15' 8"
Min. Transport Width	8'
Overall Length	15' 6"
Machine Weight - lb (kg)	3,730 (1692)
Tongue Weight - lb	1,240
Cutting Height	2" - 14"
Cutting Capacity	2-1/2"
Height Adjustment	3" x 8" Cylinder, Hose, Fittings & Stroke Control Spacers
Deck Thickness	10 Gauge
Deck Height	12"
Deck Shock Protection	Spring Cushioned Center Axle
Deck Rings	Optional
Side Thickness	1/4"
Safety Guards (must choose)	Front & Rear: Single or Double Chain or Rubber
Skid Shoes	Wings and Center, Replaceable
Blades (2 per section)	1/2" x 4" Heat Treated Free Swinging Alloy Steel w/Uplift
Blade Bolt	Keyed with Hardened Flatwasher & Lock Nut
Blade Overlap	6"
Blade Tip Speed (Feet per minute)	540 RPM: 15,268 fpm on Center, 15,000 fpm on Wings 1000 RPM: 15,578 fpm on Center, 14,620 fpm on Wings
Dishpan	3/16" Round, Dish Shaped with 1" x 4" Blade Bar
Hydraulics	Wings: 2-1/2" x 12" Cylinder, Hoses & Fittings
Gearbox	540 or 1000 RPM: 160 HP Divider, 110 HP Center & Wings
Gearbox Output Shaft	2"
Gearbox Input Shaft	1-3/4" 20 Spline
Input Driveline	Cat. 6 CV or Cat. 5 Conventional
Connecting Drivelines	Cat. 4 with Slip-Clutch
Max. Turning Angle	80° w/Constant Velocity U-Joint
Tires - 4 or 6	21" Laminated 29" Used Aircraft 25.5" Foam-Filled

See dealer for complete warranty information.

Color Options:





# RC4015 15' FOLDING ROTARY CUTTERS

## The Best of Both.

Combine the rugged, heavy-duty gearboxes from our RC5615 and the proven, dependable deck from our RC3615 and you get the new Land Pride RC4015. With a 3-1/2" cutting capacity and a blade tip speed of 16,300 fpm, the RC4015 is a solid medium-duty cutter in a long line of quality folding cutters from Land Pride.

# RANCHER

3-1/2"  
CUTTING  
CAPACITY

3-1/2"

**NEW!**



See a Video of the RC4015  
at [landpride.com](http://landpride.com)



	RC4015 & RCM4015
Horsepower	50-200 HP
Working Width (cm)	15' (457)
Overall Width	15' 9"
Min. Transport Width	8'
Overall Length	15' 6"
Machine Weight - lb (kg)	3,930 (1782)
Tongue Weight - lb	1,300
Cutting Height	2" - 14"
Cutting Capacity	3-1/2"
Height Adjustment	3" x 8" Cylinder, Hose, Fittings & Stroke Control Spacers
Hitch	Standard Clevis, Swivel, Ball, Pintle, or Bar-Tite Hitch
Deck Thickness	10 Gauge
Deck Height	12"
Deck Shock Protection	Spring Cushioned Center Axle
Deck Rings	Optional
Side Thickness	1/4"
Safety Guards (must choose)	Front & Rear: Single or Double Chain or Rubber
Skid Shoes	Wings and Center, Replaceable
Blades (2 per section)	1/2" x 4" Heat Treated Free Swinging Alloy Steel w/Uplift
Blade Bolt	Keyed with Hardened Flatwasher & Lock Nut
Blade Overlap	6"
Blade Tip Speed (Feet per minute)	540 RPM: 16,300 fpm on Center, 16,300 fpm on Wings 1000 RPM: 16,288 fpm on Center, 16,000 fpm on Wings
Dishpan	3/16" Round, Dish Shaped with 1" x 4" Blade Bar
Hydraulics	Wings: 2-1/2" x 12" Cylinder, Hoses & Fittings
Gearbox	540 or 1000 RPM: 250 HP Divider, 210 HP Center & Wings
Gearbox Output Shaft	2-3/8"
Gearbox Input Shaft	1-3/4" 20 Spline
Input Driveline	Cat. 6 CV or Cat. 5 Conventional
Connecting Drivelines	Cat. 4 with Slip-Clutch
Max. Turning Angle	80° with Constant Velocity U-Joint
Tires - 4 or 6	21" Laminated 29" Used Aircraft 25.5" Foam-Filled

See dealer for complete warranty information.

Color Options: 

**7 YEAR**  
Limited Gearbox  
Warranty



# RC5615 15' FOLDING ROTARY CUTTERS

## Smooth top and bottom design.

Land Pride's 56 Series, 15-foot cutter is smooth on top, which allows debris and moisture to roll off or be easily swept or blown off. And it's smooth on bottom, which means less chance of dry caking material getting lodged in tight corners, which again, means less time for cleaning.

The 56 Series also features independent spring-cushioned wheel arms for more cushion going through rough terrain, which gives you an easier and more comfortable ride.



4"  
CUTTING  
CAPACITY

4"



# Commander

- 9' 1" Transport Width
- Smooth top and bottom design
- Replaceable 1/4" side skirts with replaceable skid shoes
- High blade tip speed

**Heavy-Duty Dishpan**  
This is spin balanced for smooth operation.

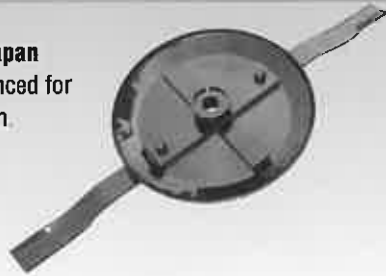

**Skid Shoes**  
Our center skid shoes allow the cutter to "glide" over bumps and undulations and protects the turf, as well as various components on the cutter.

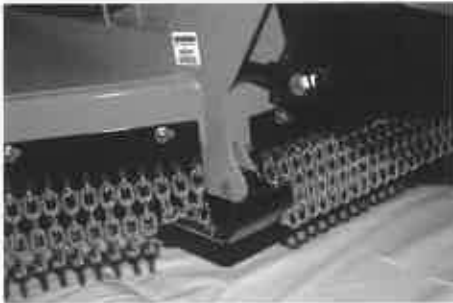

**First Class Cut**  
Our blade tip speed, along with our pre-cut chamber and a longer than average cutting edge on the blade together offer the best cut in the industry!

**Deck Rings**  
Deck rings are available offering additional deck strength and help eliminate damage from obstructions.



**Pre-Cut Chamber**  
The Dominator and Commander 10' and 15' Cutters feature a Pre-Cut Chamber. This allows material to spring back up before being cut, giving a cleaner, more precise finish.

**Double Your Smooth**  
The top and bottom sides of the cutter are smooth, with a structured membrane in between. This double smooth design allows for easier cleaning of both sides, as well as eliminates bottom structures that cake material.

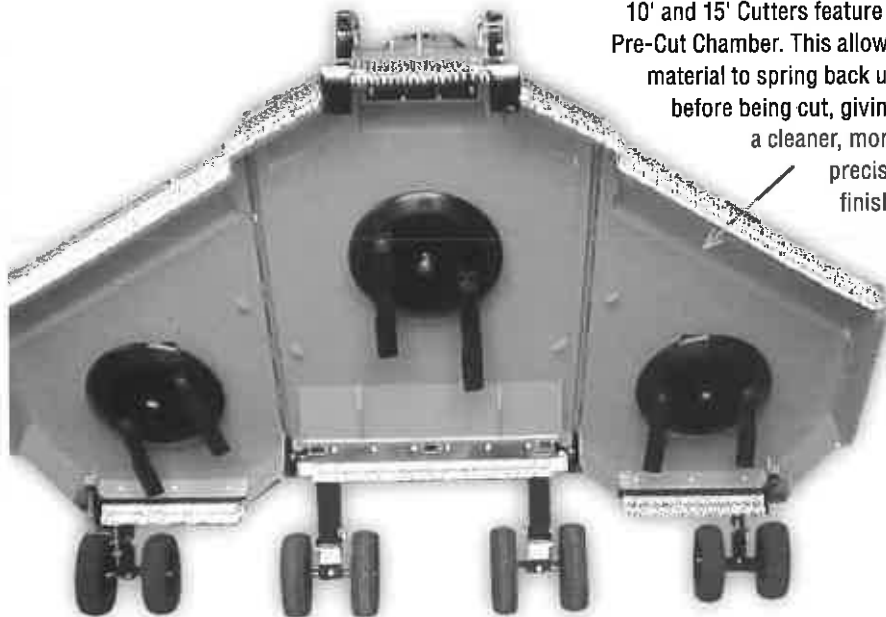

RC5615 HEAVY DUTY	
Horsepower	50-250 HP
Working Width (cm)	15' (457)
Overall Width	15' 8"
Min. Transport Width	9' 1"
Overall Length	16'
Machine Weight - lb (kg)	5,446 (2470)
Cutting Height	2" - 14"
Cutting Capacity	4"
Hitch	Standard Clevis, Swivel, Ball, Pintle, or Bar-Tite Hitch
Tongue Weight - lb	2,080
Deck Thickness	7 Gauge bottom; 10 Gauge Top
Deck Height	12"
Deck Shock Protection	Independent Wheel Arm Springs
Side Thickness	1/4" Replaceable
Safety Guards (must choose)	Front & Rear: Single or Double Chain or Rubber Guard
Skid Shoes	Wings and Center, Replaceable
Blades	1/2" x 4" Heat Treated Free Swinging Alloy Steel w/Uplift
Blade Bolt	Keyed with Hardened Flatwasher & Lock Nut
Blade Overlap	6"
Blade Tip Speed (Feet per minute)	540 RPM: 16,300 fpm on Center, 16,300 fpm on Wings; 1000 RPM: 16,300 fpm on Center, 16,000 fpm on Wings
Dishpan	3/16", Round, Dish Shaped with 1" x 5" Blade Bar
Hydraulics	Wings: 3" x 8" Cylinder, Hoses and Fittings Axles: 3-1/2" x 8"
Gearbox	540 or 1000 RPM: 250 Center, 210 Wings
Gearbox Output Shaft	2-3/8"
Gearbox Input Shaft	1-3/4" 20 spline
Input Driveline	Cat. 6 CV or Cat. 5 Conventional
Connecting Drivelines	Choice of Cat. 4 or Cat. 5 Driveline Slip-Clutch
Maximum Turning Angle	80° with Constant Velocity U-Joint
Tires - 6 or 8	21" Laminated 29" Used Aircraft 25.5" Foam-Filled

See dealer for complete warranty information.

Color Options:





## Smooth all the way around.



### Commander

The RC5515 not only features a smooth top, but our underside is just as smooth. Fewer nooks or crannies for debris to compact in and no frame members to get hung up on obstructions.



**Pre-Cut Chamber**  
The Dominator and Commander 10' and 15' Cutters feature a Pre-Cut Chamber. This allows material to spring back up before being cut, giving a cleaner, more precise finish.

**4" CUTTING CAPACITY**

Heavy-Duty Dishpan is spin balanced for smooth operation.

**7 YEAR**  
Limited Lifetime  
Warranty

RC5515 HEAVY DUTY	
Horsepower	50-250 HP
Hitch	Pull-Type, Self-Leveling Hitch & Clevis
Working Width (cm)	15' (457)
Overall Width	15' 8"
Min. Transport Width	8' 6"
Overall Length	16' 5"
Machine Weight - lb (kg)	5,529 (2507)
Cutting Height	2" - 14"
Cutting Capacity	4"
Hitch	Standard Clevis, Swivel, Ball, Pintle, or Bar-Tite Hitch
Tongue Weight - lb	1,860
Max. Turning Angle	80° with Constant Velocity U-Joint
Deck Thickness	7 Gauge Bottom, 10 Gauge Top
Deck Height	12"
Deck Shock Protection	Spring Cushioned Center Axle
Side Thickness	1/4" Replaceable
Safety Guards (must choose)	Front & Rear: Single or Double Chain or Rubber Guard
Skid Shoes	Wings and Center, Replaceable
Hydraulics	Wings: 3" x 12" Cylinder, Hoses and Fittings
Blades	1/2" x 4" Heat Treated Free Swinging Alloy Steel w/Offset
Blade Bolt	Keyed with Hardened Flatwasher & Lock Nut
Blade Tip Speed (Feet per minute)	540 RPM: 14,886 fpm on Center, 14,769 fpm on Wings; 1000 RPM: 15,604 fpm on Center, 15,741 fpm on Wings
Blade Overlap	6"
Dishpan	3/16" Round, Dish Shaped with 1" x 5" Blade Bar
Gearbox	540 or 1000 RPM; 250 Center, 210 Wings
Gearbox Output Shaft	2-3/8"
Gearbox Input Shaft	1-3/4" 20 Spline
Input Driveline	Cat. 6 CV or Cat. 5 Conventional
Connecting Drivelines	Choice of Cat. 4 or Cat. 5 Driveline Slip-clutch
Tires 6 or 8	21" Laminated 29" Used Aircraft 25.5" Foam-Filled

See dealer for complete warranty information.

**Color Options:**

- Center walking tandem axle available
- Replaceable 1/4" side skirts with replaceable skid shoes
- Front and rear guard options include: rubber, single chain, double chain, double chain w/cable
- Optional deck rings; Optional shredder kit

RC6515 EXTRA HEAVY DUTY	
Horsepower	50-250 HP
Hitch	Pull-type, Self-leveling Hitch & Clevis
Working Width (cm)	15' (457)
Overall Width	15' 8"
Min. Transport Width	8' 6"
Overall Length	15' 1"
Machine Weight - lb (kg)	5,559 (2521)
Cutting Height	2" - 14"
Cutting Capacity	4-1/2"
Hitch	Standard Clevis, Swivel, Ball, Pintle, or Bar-Tite Hitch
Tongue Weight - lb	1,860
Deck Thickness	7 Gauge Bottom, 10 Gauge Top
Deck Height	12"
Deck Shock Protection	Spring Cushioned Axle
Deck Rings	Optional
Side Thickness	1/4" Replaceable
Safety Guards (must choose)	Front: Single or Double Chain or Rubber Guard Rear: Single or Double Chain or Rubber Guard
Skid Shoes	1 each Wing, 2 on Center Section, Replaceable
Hydraulics	Wings: 3" x 8" Cylinder, Hoses and Fittings Axle: 3.5" x 8" Cylinder, Hoses, Fittings & Stroke Control Spacers
Blades	1/2" x 4" Heat Treated Free Swinging Alloy Steel w/Uplift
Blade Bolt	Keyed with Hardened Flatwasher & Lock Nut
Blade Tip Speed (Feet per minute)	540 RPM: 14,886 fpm on Center, 14,769 fpm on Wings 1000 RPM: 15,604 fpm on Center, 15,741 fpm on Wings
Blade Overlap	6"
Dishpan	3/16" Round, Dish Shaped with 1" x 5" Blade Bar
Gearbox	540 RPM or 1000 RPM: 250 HP Divider, 210 HP Center & Wings
Gearbox Output Shaft	2-3/8"
Gearbox Input Shaft	1-3/4" 20 Spline
Input Driveline	Cat. 6 CV or Cat. 5 Conventional
Drivelines	Cat. 5 Slip-Clutch
Max. Turning Angle	80° with Constant Velocity U-Joint
Tires - 6 or 8	21" Laminated 29" Used Aircraft 25.5" Foam-Filled

## DOMINATOR



Center Walking Tandem axle is available as an option on the 65 Series Cutters. The Walking Tandem axle allows for a smoother pull over rough terrain during cutting and transport.

Land Pride strongly recommends that front and rear shielding be used with any Rotary Cutter. However, they can be purchased with or without shielding. Please understand how your cutter is to be equipped for you.

← 4-1/2" →

**4-1/2" CUTTING CAPACITY**

- 4-1/2" Cutting capacity
- Smooth top and bottom
- Replaceable side skirts with replaceable skid shoes
- Extra heavy-duty gearboxes with 2-3/8" output shafts
- Optional deck rings
- Optional center walking tandem axle

Choice of recapped aircraft tires, used aircraft tires w/wo foam or laminated tires.

See dealer for complete warranty information.

Color Options:



## Nothing stands in our way!

The extra heavy-duty 66 Series Rotary Cutter has that extra muscle to cut in extreme conditions, and still give you the excellent appearance when completed.

Cutting 4-1/2" material allows you to tackle a great deal of obstacles when cleaning up neglected pastures or fields.

4-1/2"  
CUTTING  
CAPACITY



# DOMINATOR



**Extra Heavy-Duty Dishpan**  
Our 1" thick plate adds superior strength to our dishpan.

The springs located in each wheel arm allows the shock loads to be minimized throughout the entire axle. The independent springs allow for a smooth ride through the field.





RC6615 EXTRA HEAVY DUTY	
Horsepower	50-250 HP
Hitch	Pull-Type, Self-leveling Hitch & Clevis
Working Width (cm)	15' (457)
Overall Width	15' 8"
Min. Transport Width	9' 1"
Overall Length	16'
Machine Weight - lb (kg)	5,660 (2567)
Cutting Height	2' - 14"
Cutting Capacity	4-1/2"
Hitch	Standard Clevis, Swivel, Ball, Pintle, or Bar-Tite Hitch
Tongue Weight - lb	2,080
Deck Thickness	7 Gauge Bottom, 10 Gauge Top
Deck Height	12"
Deck Shock Protection	Independent Wheel Arm Springs
Deck Rings	Optional
Side Thickness	1/4" Replaceable
Safety Guards (must choose)	Front: Single or Double Chain, Double Chain Guard w/Cable, or Rubber Guard Rear: Single or Double Chain, Double Chain Guard w/Cable, or Rubber Guard
Skid Shoes	1 Each Wing, 2 on Center Section, Replaceable
Blades	1/2" x 4' Heat Treated Free Swinging Alloy Steel w/Uplift
Blade Bolt	Keyed with Hardened Flatwasher & Lock Nut
Blade Tip Speed (Feet per minute)	540 RPM: 16,300 fpm on Center, 16,300 fpm on Wings 1000 RPM: 16,300 fpm on Center, 16,000 fpm on Wings
Blade Overlap	6"
Dishpan	3/16" Round, Dish Shaped with 1" x 5" Blade Bar
Hydraulics	Wings: 3" x 8" Cylinder, Hoses and Fittings Axle: 3.5" x 8" Cylinder, Hoses, Fittings & Stroke Control Spacers
Gearbox	540 RPM or 1000 RPM: 250 HP Divider, 210 HP Center & Wings
Gearbox Output Shaft	2-3/8"
Gearbox Input Shaft	1-3/4" 20 Spline
Input Driveline	Cat. 6 CV or Cat. 5 Conventional
Connecting Drivelines	Star Shaped Cat. 5 Slip-Clutch
Max. Turning Angle	80° with Constant Velocity U-Joint
Tires - 6 or 8	21" Laminated 29" Used Aircraft 25.5" Foam-Filled

The gearbox on our 66 Series cutters tell the 4-1/2" story. Our upper and lower bearings are further apart than on our other gearboxes. By spreading these apart, the output shaft and the heavy-duty dishpan can take the rigorous use these cutters are intended for.

Color Options:  

Optional full welded deck rings keep blades from damaging the deck.

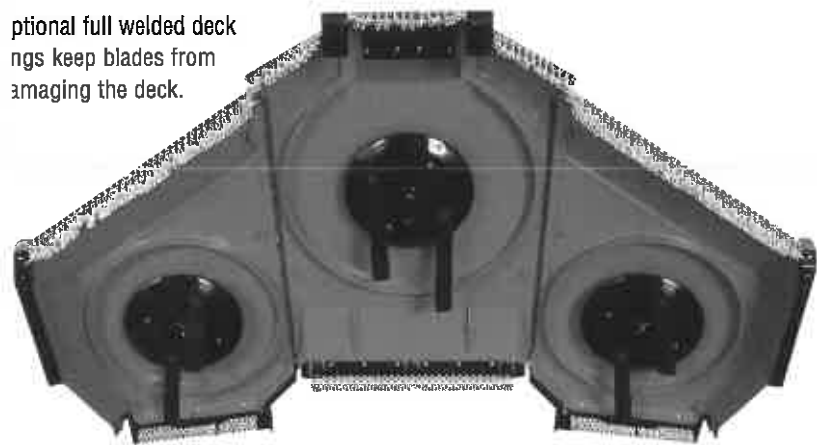

See dealer for complete warranty information.

Land Pride strongly recommends that front and rear shielding be used with any Rotary Cutter. However, they can be purchased with or without shielding. Please understand how your cutter is to be equipped for you.





## Go all in with your next bid!



All of the features found on our RCB66 Series Rotary Cutter and more!



**Extra Heavy-Duty Dishpan**  
Our 1" thick plate adds superior strength to our dishpan.

4-1/2"

Our RCB66 Series Rotary Cutters offer many of the additional features that counties, states, and contract cutters are looking for.

- 4-1/2" Cutting capacity
- 7 Gauge bottom, 10 gauge top
- 12" Deck height
- Extra heavy-duty gearboxes with 2-3/8" output shafts
- Spring cushioned axle
- Optional deck rings
- Optional tool box\*
- Rephasing cylinders on wing axles for levelling the wings\*
- Optional walking tandem axles on center and wings for a smoother pull
- Independent wing hydraulics
- Cable winch (optional) for raising or lowering the wings in a hydraulic failure
- Wing skid shoe: AR400 steel\*
- SMV Sign\*

RCB66 15' EXTRA HEAVY DUTY	
Horsepower	50-250 HP
Hitch	Pull-Type, Self-leveling Hitch & Clevis
Working Width (cm)	15' (457)
Overall Width	15' 8"
Min. Transport Width	9'1"
Overall Length	17' 1"
Machine Weight - lb (kg)	5,738 (2603)
Cutting Height	2" - 14"
Cutting Capacity	4-1/2"
Hitch	Standard Clevis, Swivel, Ball, Pintle, or Bar-Tite Hitch
Tongue Weight - lb	1,842
Deck Thickness	7 Gauge Bottom, 10 Gauge Top
Deck Height	12"
Deck Shock Protection	Spring Cushioned Axle
Deck Rings	Optional
Side Thickness	1/4" Replaceable
Safety Guards (must choose)	Front: Single or Double Chain, Dbl Chain w/Cable, or Rubber Guard Rear: Single or Double Chain, Dbl Chain w/Cable, or Rubber Guard
Skid Shoes	2 Each Wing, 2 on Center Section, Replaceable
Blede	1/2" x 4" Heat Treated Free Swinging Alloy Steel w/Uplift
Blade Bolt	Keyed with Hardened Flatwasher & Lock Nut
Blade Tip Speed (Feet per minute)	540 RPM: 16,300 fpm on Center, 16,300 fpm on Wings 1000 RPM: 16,300 fpm on Center, 16,000 fpm on Wings
Blade Overlap	8"
Dishpan	3/16" Round, Dish Shaped with 1" Steel Plate Support
Hydraulics	6" Wings-3-1/2" x 8" Cylinder Axle-Center-3-1/2" x 8" Cylinder RH Wing-3-1/4" x 8", LH Wing-3" x 8"
Gearbox	540 RPM or 1000 RPM: 250 HP Drive 210 HP Center & Wings
Gearbox Output Shaft	2-3/8"
Gearbox Input Shaft	1-3/4" 20 Spline
Input Driveline	Cat. 6 CV or Cat. 5 Conventional
Connecting Drivelines	Cat. 5 Slip-Clutch
Max. Turning Angle	80° with Constant Velocity U-Joint
Tires - 6 or 8	21" Laminated 29" Used Aircraft 25.5" Foam-Filled

See dealer for complete warranty information.

Color Options:



## Tested Using Rugged Industry Standards

In our continuing effort to manufacture products in a responsible manner, all Land Pride Rotary Cutters have been designed, tested and found to meet the rigorous voluntary testing requirements of safety tests specified in ISO 4254-13, ASABE S474 and SAE J232 Standards. These cutters, however, like any piece of power driven equipment, are only as safe as the care and concern of the operator and the way they are used.

**Blade Unbalance Test:** One blade is removed and cutter ran for two minutes to evaluate the structural integrity of the complete cutter and power train.



**Thrown Object Test:** 3600 Nails per spindle are dropped through multiple holes in the top side of the deck into the rotating blades to evaluate deck design and safety guards.

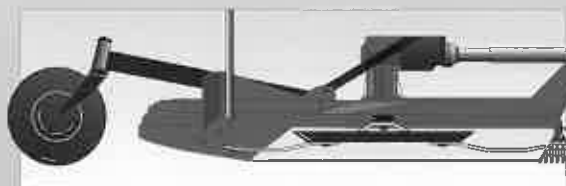

**Blade Impact Test:** Rotary Cutter is lowered onto a vertical 2" steel stake while running at optimum blade tip speed to evaluate the integrity of the complete power train.



**Foot Probe Test:** 8" Leg to toe with a 4" in-step model foot is inserted under the perimeter of the deck to evaluate its relationship with the rotating blades.

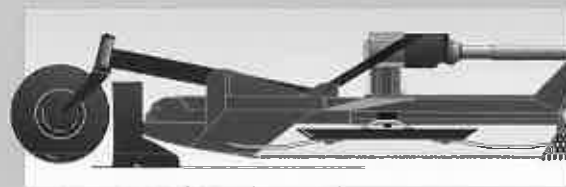

Drawings are for illustration purposes only

## Making roadside cutting safe and efficient.



RC5610

Land Pride's wheel base offers a smoother pull of the cutter, which holds slopes better and reduces overall operator fatigue.



- Left hand weight box
- 5 or 6 Wheel option
- Optional hitch configurations
- Optional walking tandem axle on center of RC55 & RC65
- Optional deck rings

- Replaceable 1/4" sideskirt with replaceable skid shoe
- Smooth top design
- Heavy-duty dishpans
- 4' Cutting capacity on RC55, RC56
- 4-1/2" Cutting capacity on RC65, RC66

Color Options:

	RC5510, RC5610, RC6510, RC6610
Horsepower	50-250 HP
Hitch	Pull-type, Self-Leveling Clevis
Working Width (cm)	10' 6" (320)
Overall Width	11'7"
Min. Transport Width	7' 6-1/2"
Overall Length	16' 5"
Machine Weight - lb (kg)	RC55 & 65: 4,977 (2258) RC56 & 66: 5,292 (2400)
Cutting Height	2' - 14"
Cutting Capacity	RC55 & 56: 4'; RC65 & 66: 4-1/2'
Tongue Weight - lb	1,880
Hitch	Standard Clevis, Swivel, Ball, Pintle, or Bar-Tite Hitch
Deck Thickness	7 Gauge Bottom, 10 Gauge Top
Deck Height	12"
Deck Shock Protection	RC55 & 65: Spring Cushioned Axle RC56 & 66: Independent Wheel Air Springs
Deck Rings	Optional
Side Thickness	1/4" Replaceable
Skid Shoes	1 Each Wing, 2 on Center Section, Replaceable
Safety Guards (must choose)	Front: Single or Double Chain, Double Chain with Cable, or Rubber Guard Rear: Single or Double Chain, Double Chain with Cable, or Rubber Guard
Blades	1/2" x 4" Heat Treated Free Swinging Alloy Steel w/Uplift
Blade Bolt	Keyed with Hardened Flatwasher & Lock Nut
RC55/65 Blade Tip Speed (Feet per minute)	540 RPM: 14,886 fpm on Center, 14,789 fpm on Wings 1000 RPM: 15,904 fpm on Center, 15,741 fpm on Wings
RC56/66 Blade Tip Speed (Feet per minute)	540 RPM: 16,300 fpm on Center, 16,300 fpm on Wings 1000 RPM: 16,300 fpm on Center, 16,000 fpm on Wings
Blade Overlap	6"
Dishpan	3/16" Round, Dish Shaped with 1" x 5" Blade Bar
Hydraulics	RC55 & 65: Wings: 3" x 12" Cylinder, Hoses and Fittings RC56 & 66: Wings: 3" x 8" Cylinder, Hoses and Fittings Axle: 3.5" x 8" Cylinder, Hoses, Fittings, & Stroke Control Spacers
Gearbox	540 RPM or 1000 RPM: 250 HP Divider, 210 HP Center & Wings
Gearbox Output Shaft	2-3/8"
Gearbox Input Shaft	1-3/4" 20 Spline
Input Driveline	Cat. 6 CV or Cat. 5 Conventional
Connecting Drivelines	Cat. 4 or 5 with 5 Slip-Clutch
Max. Turning Angle	80° with Constant Velocity U-Joint
Tires - 5 or 6	21" Laminated 29" Used Aircraft 25.5" Foam-Filled

See dealer for complete warranty information.

## 14' — Largest offset cutter in the family!



A 14' swath on a roadside can knock out a lot of work in one pass. Equipped with extra heavy-duty gearboxes and levelines, and a dish pan to help protect it all, this cutter is ready to go to work!

### Commander

- Heavy-duty stump jumper
- Left side weight box



Choice of used aircraft tires or foam or laminated tires.



#### Hitches Available on all 36 Series and above Folding Cutters



**Standard Clevis Hitch**  
Swivels up and down for uneven terrain



**Double Swivel Clevis Hitch**  
Swivels up and down and side to side



**Bar-tite™ Clevis Hitch**  
Bolts tight to drawbar which eliminates drawbar wear. Swivels up and down, and rotates on greasable shaft

	RC5014
Horsepower	70-250 HP
Hitch	Pull-type, Self-Leveling Clevis
Working Width (cm)	13' 6"
Overall Width	14' 7"
Min. Transport Width	8' 9"
Overall Length	19' 3" w/Laminated Tires
Machine Weight - lb (kg)	7,282 (3303)
Cutting Height	2" - 14"
Cutting Capacity	3" Diameter
Tongue Weight - lb	2,300
Hitch	Standard Clevis, Swivel, Ball, Pintle, or Bar-Tite Hitch
Deck Thickness	3/16"
Deck Height	10-1/2"
Deck Shock Protection	Spring Cushioned Axle
Deck Rings	Optional
Side Thickness	1/4"
Safety Guards (must choose)	Single or Double Chain or Rubber
Skid Shoes	1 on Wing and Weight Box, 2 on Center Section, Replaceable
Blades	1/2" x 4" High Lift
Blade Bolt	Keyed with Hardened Flatwasher & Lock Nut
Blade Tip Speed (Feet per minute)	540 RPM: 17,377 fpm on Center, 17,329 fpm on Wings 1000 RPM: 18,165 fpm on Center, 18,317 fpm on Wings
Blade Overlap	6"
Dishpan	3/16" Round, Dish Shaped w/1" Steel Plate Support
Hydraulics	Wings: 3-1/2" x 8" Cylinder, Hoses and Fittings Axle: 4" x 8" Cylinder, Hoses, Fittings and Stroke Control Spacers
Gearbox	540 RPM or 1000 RPM: 250 HP Divider, 210 HP Center & Wing
Gearbox Output Shaft	2-3/8"
Gearbox Input Shaft	1-3/4" 20 Spline
Input Driveline	Cat. 6 CV or Cat. 5 Conventional
Connecting Drivelines	Slip Clutch; Cat. 5
Max. Turning Angle	80° with Constant Velocity U-Joint
Tires - 5 or 6	21" Laminated 29" Used Aircraft 27" Foam-Filled

See dealer for complete warranty information.



## Plainsman



Land Pride's RC3620 is the ideal rotary cutter for grassy fields, pastures, waterways, buffer strips, and set-aside acres and handles saplings up to 2" in diameter. With tip speeds of 16,000 to 16,500, gearboxes rated at 250 HP and 130 HP, 1-3/4" input shafts and 2" output shafts, and optional CV drivelines, this unit will make quick and efficient work of the largest jobs.



RC3620 MEDIUM DUTY	
Horsepower	70-160 HP
Hitch	Pull-type
Working Width (cm)	20' (607)
Overall Width	20' 10"
Min. Transport Width	9' 11"
Overall Length	17' 6" with Laminated Tires
Machine Weight - lb (kg)	6,280 (2849)
Cutting Height	2" - 12"
Cutting Capacity	2" Diameter
Hitch	Standard Clevis, Swivel, Ball, Pintle, or Bar-Tite Hitch
Tongue Weight - lb	1,750
Max. Turning Angle	80° with Constant Velocity U-Joint
Deck Height	13"
Deck Thickness	10 Gauge
Deck Shock Protection	Spring Cushioned Axle
Deck Rings	Optional
Side Thickness	1/4"
Safety Guards (must choose)	Front & Rear: Single or Double Chain
Skid Shoes	1 Each Wing, 2 on Center Section Replaceable
Blades	1/2" x 4" High Lift
Blade Bolt	Keyed with Hardened Flatwasher Lock Nut
Blade Tip Speed (Feet per minute)	540 RPM: 16,000 fpm on Center 16,000 fpm on Wings 1000 RPM: 16,500 fpm on Center, 16,500 fpm on Wings
Blade Overlap	6"
Dishpan	10 Gauge Round, Dish Shaped w/ 1" x 4-1/2" Blade Bar
Hydraulics	Wings: 3" x 12" Cylinder, Hoses and Fittings Axle: Center-2-3/4" x 8" Cylinder RH Wing-3" x 8", LH Wing-3-1/4" x 8" Hoses, Fittings and Stroke Control Spacers
Gearbox	540 RPM or 1000 RPM: 250 HP Splitter, 130 HP Wings & Deck
Gearbox Output Shaft	2"
Gearbox Input Shaft	1-3/4" 20 Spline
Input Driveline	Cat 6 CV or Cat 5 Conventional
Connecting Drivelines	4-Plate Slip Clutch: Cat 4
Tires 6 or 8	21" Laminated 29" Used Aircraft 27" Foam-Filled

See dealer for complete warranty information.





# Be More Productive, 20' At a Time.



Roadsides, pastures, set-aside acres and crop residue are perfect jobs for the 20' Commander. Wing decks float independently, and follow the contour of the land leaving a nicely cut surface.

3"

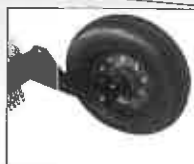

The 20' cutting width, 2" to 14' cutting height and ability to cut weeds and brush up to 3" in diameter make the RC5020 well suited for varied applications. Various safety guard choices make these an excellent choice for state and municipal mowing applications.

Outer wing wheels can be single or dual. Duals are ideal when mowing in areas where one wing needs to flex uphill. The outer wheel rides up the embankment and keeps the deck from gouging. Wheel spindles are bolt-in to allow easy change out.



## Commander

RC5020 HEAVY DUTY	
Horsepower	70-250 HP
Hitch	Pull-type
Working Width (cm)	20' (607)
Overall Width	20' 9-1/2"
Min. Transport Width	8' 9"
Overall Length	19' 3" with Laminated Tires
Machine Weight - lb (kg)	6,528 (2961)
Cutting Height	2" - 14"
Cutting Capacity	3" Diameter
Hitch	Standard Clevis, Swivel, Ball, Pintle, or Bar-Tite Hitch
Tongue Weight - lb	2,300
Maximum Turning Angle	80° with Constant Velocity U-Joint
Deck Thickness	3/16"
Deck Height	10-1/2"
Deck Shock Protection	Spring Cushioned Axle
Deck Rings	Optional
Side Thickness	1/4"
Safety Guards (must choose)	Front and Rear: Single or Double Chain or Rubber
Skid Shoes	Reversible, 1 each wing, 2 on center section, replaceable
Blades	1/2" x 4" High Lift
Blade Bolt	Keyed with Hardened Flatwasher & Lock Nut
Blade Tip Speed (Feet per minute)	540 RPM: 17,377 fpm on Center, 17,329 fpm on Wings 1000 RPM: 18,165 fpm on Center, 18,317 fpm on Wings
Blade Overlap	6"
Dishpan	3/16" Round, Dish Shaped w/ 1" Steel Plate Support
Baffle Kit	Optional - Rear
Hydraulics	Wings: 3-1/2" x 12" Cylinder, Hoses and Fittings Axle: 4" x 8" Cylinder, Hoses, Fittings and Stroke Control Spacers
Gearbox	540 RPM or 1000 RPM: 250 HP Divider, 210 HP Center & Wings
Gearbox Output Shaft	2-3/8"
Gearbox Input Shaft	1-3/4" 20 Spline
Input Driveline	Cat. 6 CV or Cat. 5 Conventional
Connecting Drivelines	4-Plate Slip Clutch, Cat. 5
Tires 6 or 8	21" Laminated 29" Used Aircraft 27" Foam-Filled

See dealer for complete warranty information.



### Optional Shredder & Baffle Kit

The double stacked blade configuration on the Shredder kit is ideal for cutting residue into smaller pieces, while the Baffle kit maintains the cut material in each section of the cutter for a consistent discharge from the rear of each deck.



A stationary blade mounted to the deck completes the shredding process.





A Division of Great Plains Mfg., Inc.  
1525 E. North St. • P.O. Box 5060  
Salina, Kansas 67401  
Visit our dealer locator at [landpride.com](http://landpride.com)

**LP** *Consistently Leading the Way...*

All-Flex Mowers • All-Purpose Seeders • Angle Brooms • Bale Spears • Box Scrapers • Compact Drills  
Core Aerators • Crimpers • Disc Harrows • Ditchers • Drag Harrows • Drag Scrapers • Fertilizer Spreaders  
Flail Mowers • Food Plot Seeders • Grading Scrapers • Grapples • Grooming Mowers • Hydraulic Reservoir Kits  
Landscape Rakes • Overseeders • Pallet Forks • Pasture Aerators • Post Hole Diggers  
Powered Rakes • Primary Seeders • Quick-Hitches • Rear Blades • Rotary Cutters • Rotary Tillers  
Scarifiers • Seed Bed Rollers • Snow Blowers • Soil Pulverizers • Spike Tooth Harrows  
Stump Grinders • Trip Edge Snow Blades • Wood Chippers • Zero Turn Mowers

**FAIRPLAIN TRACTOR SALES**  
1169 RIPLEY RD  
RIPLEY, WV 25271  
304-372-9875  
Email: [tractorsales@wirefire.com](mailto:tractorsales@wirefire.com)

Printed in U.S.A  
7/3/13

# Demco

# PRO

110 Gallon Sprayer  
Page 13

awn & Garden Spraying Equipment



*Doing our Best to Provide You the Best*



# SPECIAL INFORMATION

## PRICES & SPECIFICATIONS

All prices and specifications are subject to change without notice. All shipments are billed at price prevailing at time of shipments. ALL PRICES F.O.B. BOYDEN, IOWA OR AS DESIGNATED IN THIS CATALOG.

## TERMS

Concerns desiring credit must have good rating or furnish satisfactory reference before shipment will be made, otherwise all orders will be shipped C.O.D. No cash discounts allowed with C.O.D. shipments.

## ORDERING

All accounts must contact their area distributor. If your business is not located in a distributor area please call us direct. Please furnish credit and bank references with your first order.

## SHIPMENTS

Our merchandise is carefully packed and thoroughly inspected before leaving our factory. Responsibility for its safe delivery is assumed by the carrier upon acceptance of the shipment. Claims for loss or damage sustained in transit must therefore be made upon the delivering carrier as follows:

**CONCEALED LOSS OR DAMAGE** - Concealed loss or damage means loss or damage which does not become apparent until the merchandise has been unpacked. The contents may be damaged in transit due to rough handling even though the carton may not show external damage. When the damage is discovered upon unpacking, make a written request for inspection by the carrier's agent within 15 days of the delivery date. Then file a claim with the carrier, since such damage is the carrier's responsibility.

**VISIBLE LOSS OR DAMAGE** - Any external evidence of loss or damage must be noted on the freight bill or express receipt, and signed by the carrier's agent. Failure to adequately describe such external evidence of loss or damage may result in the carrier refusing to honor a damage claim. The form required to file a claim will be supplied by the carrier.

## SHIPPING ERRORS

Shipping errors resulting in shortages or goods ordered incorrectly by the customer, must be reported to Dethmers Manufacturing Company within 10 days after receipt of merchandise.

## PICK UP ORDERS

All orders picked up and signed for by the customer or customer's agent at the Boyden, Iowa plant are considered complete as signed. Customer will receive a copy of signed order at time of loading.

## PARCEL POST, U.P.S., FEDERAL EXPRESS & FREIGHT

Due to the special packing and handling on Parcel Post and United Parcel shipments, a combined shipping and handling fee will be charged on each carton. Weight limitations are as follows:

Parcel Post = 70 lbs.

UPS = 150 lbs.

Federal Express = 150 lbs. - per carton.

A pallet charge is added on all freight orders.

## RETURNS

NO GOODS ARE TO BE RETURNED TO THE DISTRIBUTOR OR DEMCO WITHOUT A RETURNED GOODS AUTHORIZATION NUMBER AND INVOICE NUMBER. When your order has been filled correctly, the concerned party returning goods must in all cases pay freight, the cost of handling and a 25% restocking charge. All goods to be returned are to be in first class condition. Additional charges will be made for goods returned in other than first class condition.

Roundup is a registered trademark of Monsanto  
TeeJet is a registered trademark of Spraying Systems Co.  
FloodJet is a registered trademark of Spraying Systems Co.  
AI TeeJet is a registered trademark of Spraying Systems Co.  
BoomJet is a registered trademark of Spraying Systems Co.  
Viton is a registered trademark of Dupont Elastomers  
Raven is a registered trademark of Raven Industries Inc.  
Hypro is a registered trademark of Hypro LLC

© 2006 Dethmers Mfg Co.

*Demco has attempted to show each and every product in this catalog in an accurate manner, yet, because we are continually "Doing Our Best to Provide You the Best," product and/or production enhancements may sometimes change the appearance of an item before new photos can be taken.*

*Demco is not responsible for typographical errors.*

# *Better agitation, better drainage*

*Just take a look inside*

*The all new DEMCO  
Pro Series tank*

*is more than  
just a liquid  
container  
that holds  
spray  
solution*



Many lawn sprayer manufacturers are good at supplying an affordable, easy to assemble product. But its functionality is a big secret until you use it for the first time. Less than desirable agitation and poor drainage are the results acquired from off-the-shelf tank designs.

*Demco*

At Demco we designed a tank specifically for our Pro Series sprayers. A molded-in baffle system provides excellent circulation and chemical suspension. And a large deep sump insures uninterrupted application.

# 5 Gallon Sprayer

## FEATURES

- 5 gallon tank with 3/4" fillwell cap.
- Dual ground driven wheel pumps with 1/2" latex hose on drive.
- Sturdy 14 gauge welded steel frame.
- Extra large 16" solid rubber tires.
- Folding flexible Lexan boom with 2 nozzles covers a 72" spray swath.
- Delivers 1 gallon of liquid per 1000 square feet.
- Dual hand control shut-off (one per nozzle).



5 Gallon Push Unit, (2 nozzles) ..... **PSL52** 38 lbs.

# 14 Gallon Sprayer



**SM14  
HYMB  
80B10**

**EX14KT**

## FEATURES

- 14 gallon tank with 5" fillwell, 1" sump and 1/2" outlet.
- Two formed steel channels bolt directly to the bottom of the tank. The rear bracket is used for the boom installation.
- 15" spray gun with adjustable nozzle. 15' lead hose (380RB).
- 12 volt continuous duty motor with a diaphragm pump with Viton® valves. Draws 4.7 amps @ 30 PSI (delivers 1.8 GPM).
- 3 GPM pump available, includes pressure gauge and regulator.
- 80" spray boom with 2 nozzles.
- 144" spray boom with 4 nozzles has spring loaded boom breakaway.
- Two booms available, all with spray nozzles and height adjustment to get correct spray pattern overlap.

*NOTE: All 14 gallon sprayers are partially preassembled.*

**HOW TO ORDER** 1. Choose desired Sprayer/Pump Model 2. Choose appropriate Accessories



### Model and Pump

14 Gallon Skid Mount, No Boom, 1.8 GPM electric pump ..... **SM14** 38 lbs.  
 14 Gallon Skid Mount, No Boom, 3 GPM electric pump, pressure gauge & regulating valve ..... **SM314** 43 lbs.



### Accessories

Universal Mounting Brackets for ATV cargo rack ..... **HYMB** 2 lbs.  
 80" Two Nozzle Boom Assembly (40" spacing) ..... **80B10** 15 lbs.  
 144" Four Nozzle Boom Assembly (40" spacing) ..... **144B14** 33 lbs.  
 Tank, Frame, Mounting Brackets and Plumbing for two tank hookup on one ATV ..... **EX14KT** 30 lbs.

# 25 Gallon Sprayer

## FEATURES

- 25 gallon tank with 5" fillwell, 1" sump, ½" outlet with agitation.
- Electric motor with a diaphragm pump and Viton® valves. Draws 9 amps @ 20 PSI (delivers 5 GPM). 35 PSI maximum spraying pressure.
- Heavy duty tube steel welded frame fits most ATV's. Tie down straps make mounting easy.
- 18" handgun with adjustable nozzle. 15' lead hose.
- Plumbing includes pressure gauge & regulator.
- 12' and 18' booms feature floodjet tips and spring loaded boom wing breakaway.
- 10 GPA at 4 MPH output.
- 21', 28' or 30' Truss-T booms feature vertical and horizontal boom breakaway with 20" nozzle spacing.

Note: Do not exceed manufacturer's load limit.  
 Note: All 25 gallon ATV sprayers are partially preassembled.



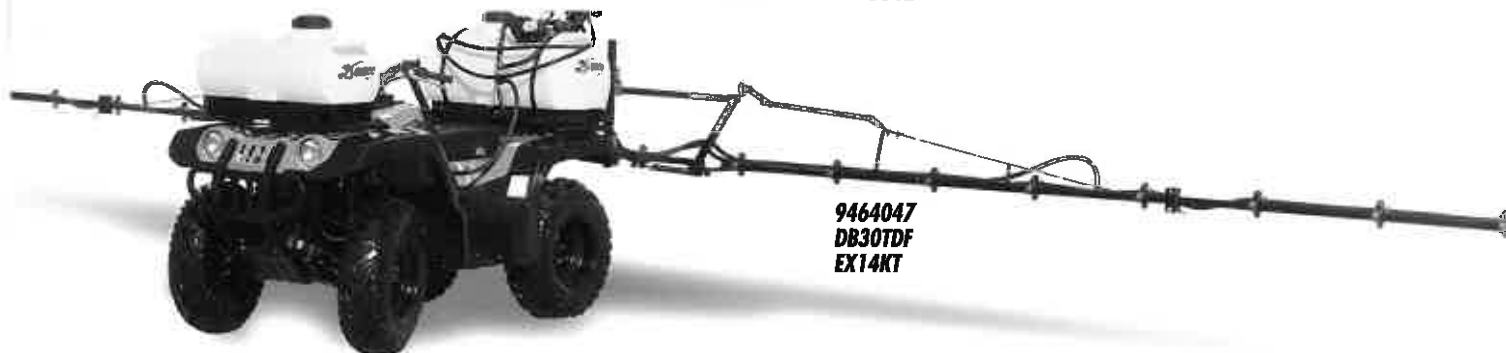

**9464047  
DB12**



**9464047  
DB30TDF  
EX14KT**



**HOW TO ORDER** 1. Choose desired Sprayer/Pump Model 2. Choose appropriate Boom 3. Choose appropriate Accessories

	<b>Model and Pump</b> 25 Gallon rear ATV Mount, 5 GPM electric pump, pressure gauge & regulating valve .....	<b>9464047</b>	74 lbs.
	<b>Boom with Plumbing</b> 12' Boom (1 section)(4 nozzles)(40" spacing) .....	<b>DB12</b>	27 lbs.
	18' Boom (1 section)(6 nozzles)(40" spacing) .....	<b>DB18</b>	38 lbs.
	21' Truss-T boom (1 section)(13 nozzles) .....	<b>DB21TDF</b>	85 lbs.
	28' Truss-T boom (1 section)(17 nozzles) .....	<b>DB28TDF</b>	110 lbs.
	30' Truss-T boom (1 section)(19 nozzles) .....	<b>DB30TDF</b>	115 lbs.
	<b>Accessories</b> 25 Gallon front tank with agitation, frame, mounting bracket and plumbing for two tank hookup on one ATV .....	<b>9464048</b>	40 lbs.
	14 Gallon front tank with agitation, frame, mounting bracket and plumbing for two tank hookup on one ATV .....	<b>EX14KT</b>	30 lbs.



# 40 Gallon Sprayer

*The perfect  
sprayer  
for lawns  
and yards*



**9464077**  
Trailer with 5 GPM electric pump

## FEATURES

- 40 gallon tank with sloped sump for better drainage, 5" fillwell, and 1 1/4" outlet.
- Gallon and liter markings on the tank.
- Agitation is standard on all tanks.
- Special molded-in baffling in bottom of tank for better agitation.
- Rugged 12 gauge formed steel skid frame.
- Bolt on tongue and axle with 15 x 6 flotation turf tires on silver rims for trailer models.
- Pressure regulator.
- Electric continuous duty motor, diaphragm pump with Viton® valves. Draws 9 amps @ 20 PSI (delivers 5 GPM). 35 PSI maximum spraying pressure.
- Hand gun with 15' spray hose (380RB).
- 80" spray boom with 2 nozzles (AN1.5). 12' boom with 4 nozzles and spring loaded boom breakaway or 18' boom with 6 nozzles.
- Receiver model requires class 4 receiver.



**9464063**  
Skid mount  
with 5 GPM  
electric pump





**9464070**  
Receiver hitch  
with 5 GPM  
electric pump



**9464084**  
Rear mount  
with 5 GPM  
electric pump



**HOW TO ORDER** Choose in this order: 1. Model 2. Boom 3. Accessories

	<b>Model and Pump</b>		
	40 Gallon Skid Mount with 5 GPM electric pump. Skid base is 26 1/2" wide x 34" deep	<b>9464063</b>	112 lbs.
	40 Gallon Receiver Hitch with 5 GPM electric pump	<b>9464070</b>	133 lbs.
	40 Gallon Trailer with 5 GPM electric pump	<b>9464077</b>	154 lbs.
	40 Gallon Rear Mount with 5 GPM electric pump	<b>9464084</b>	139 lbs.
	<b>Boom with Plumbing</b>		
	80' Boom (2 nozzles)(40" spacing)	<b>80B25</b>	10 lbs.
	12' Boom (4 nozzles)(40" spacing)	<b>DB12</b>	27 lbs.
	18' Boom (6 nozzles)(40" spacing)	<b>DB18</b>	38 lbs.
	<b>Accessories</b>		
	Hose Reel with 50' of 3/8" hose (less handgun)	<b>9428114</b>	20 lbs.
	Lawn & Turf Gun with #3 nozzle	<b>25660-3</b>	1 lbs.
	Boom Extender Kit (includes 2 XT020 tips)	<b>9428147</b>	8 lbs.



# 60 Gallon Sprayer

*Great for  
parks and  
estates*

## FEATURES

- 60 gallon tank with sloped sump for better drainage, 5" fillwell, and 1 1/4" outlet.
- Gallon and liter markings on the tank.

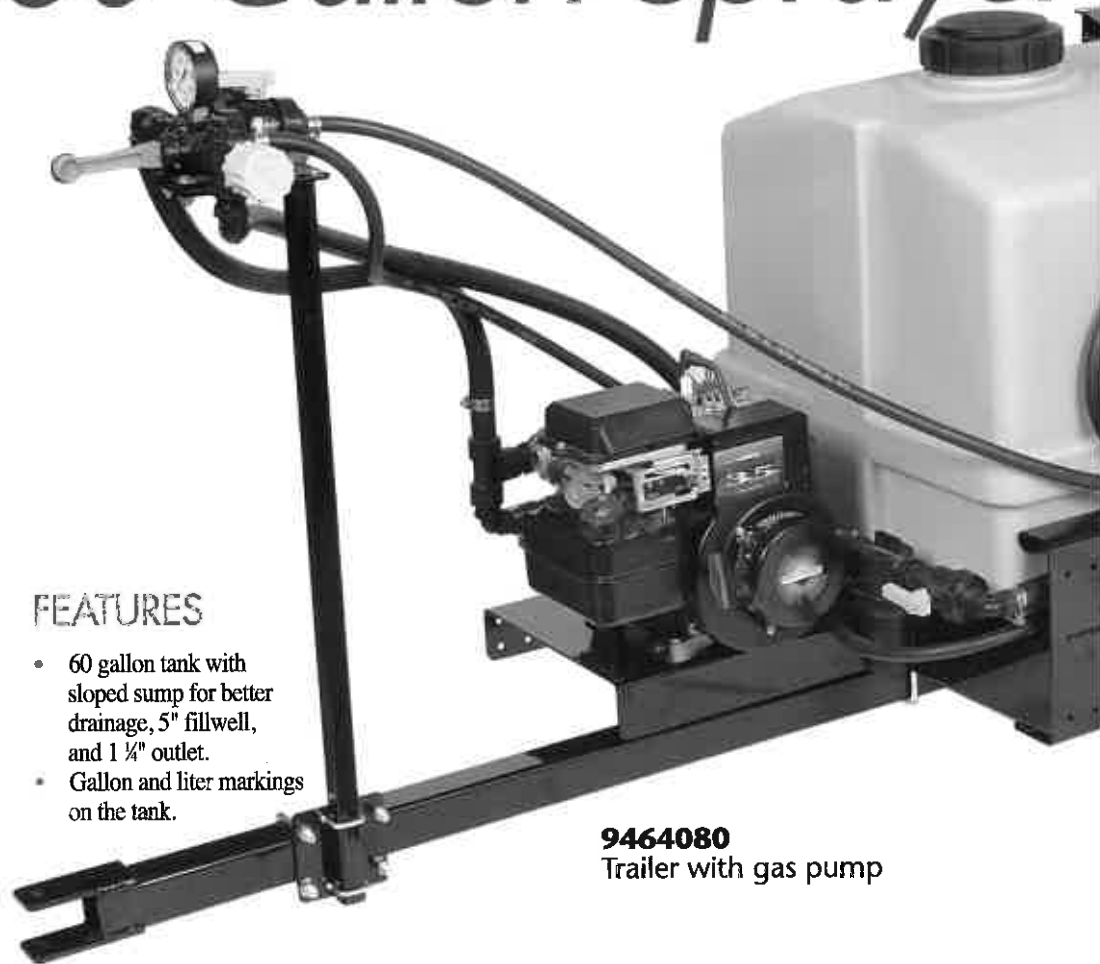

**9464080**  
Trailer with gas pump

- Agitation is standard on all tanks.
- Special molded-in baffling in bottom of all tanks for better agitation.
- Pocket on top side of tank to hold two 1 gallon jugs or one 2 1/2 gallon jug for chemical or fresh water.
- Rugged 12 gauge formed steel skid frame.
- Adjustable drawbar hitch and axles with 18 x 9.50 flotation tires on silver rims for trailer models.
- Lift kit to raise tongue height 3" is included.
- Electric continuous duty motor, diaphragm pump with Viton® valves will deliver 5 GPM. Draws 9 amps at 20 PSI.
- 3.5 HP Briggs and Stratton engine with C4101 pump delivering 6.6 GPM at 2600 RPM and 50 PSI. 150 PSI max.
- 4 HP Honda with 4 roller "Silver Cast" pump (XL4101).
- Hypro® 6 roller PTO pump (C6500D) will deliver 8 GPM at 540 RPM and 50 PSI. 150 PSI max.
- Hand gun with 15' hose (380RB).
- 80" spray boom with 2 nozzles (AN1.5), 12' spray boom with 4 nozzles and spring loaded boom breakaway or 18' boom with 6 nozzles.
- Rear mount fits category "1" three-point.
- Receiver model requires class 4 receiver hitch.
- 3-section plumbing available for 3-section 21' boom. PTO pump required.



**9464064**  
Skid mount  
with 5 GPM  
electric pump



**9464085**  
Rear mount  
with 5 GPM  
electric pump

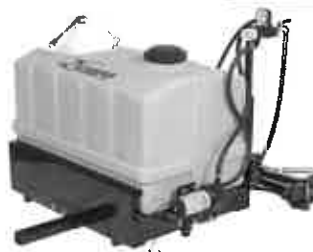

**9464071**  
Receiver hitch  
with 5 GPM  
electric pump

**HOW TO ORDER** Choose in this order: 1. Model 2. Boom 3. Accessories



**Model with Pump**

60 Gallon Skid with electric 5 GPM pump. Skid base is 26 1/2" wide x 34" deep. ....	<b>9464064</b>	122 lbs.
60 Gallon Skid with 3.5 HP B&S engine and C4101 pump Skid base is 26 1/2" wide x 34" deep. ....	<b>9464066</b>	165 lbs.
60 Gallon Skid with 4 HP Honda and "Silver Cast" pump (XL4101) Skid base is 26 1/2" wide x 34" deep. ....	<b>9464068</b>	165 lbs.
60 Gallon Receiver with electric 5 GPM pump .....	<b>9464071</b>	143 lbs.
60 Gallon Receiver with 3.5 HP B&S engine and C4101 pump .....	<b>9464073</b>	186 lbs.
60 Gallon Receiver with 4 HP Honda and "Silver Cast" pump (XL4101) .....	<b>9464075</b>	186 lbs.
60 Gallon Trailer with electric 5 GPM pump .....	<b>9464078</b>	186 lbs.
60 Gallon Trailer with 3.5 HP B&S engine and C4101 pump .....	<b>9464080</b>	229 lbs.
60 Gallon Trailer with 4 HP Honda and "Silver Cast" pump (XL4101) .....	<b>9464082</b>	229 lbs.
60 Gallon Rear Mount with electric 5 GPM pump .....	<b>9464085</b>	149 lbs.
60 Gallon Rear Mount with PTO 6 roller pump for 80", 12', or 18' boom .....	<b>9464087</b>	168 lbs.
60 Gallon Rear Mount with PTO 6 roller pump for 21', 28', or 30' boom (3-section) .....	<b>9464089</b>	183 lbs.



**Boom with Plumbing**

80" Boom (2 nozzles)(40" spacing) .....	<b>80B25</b>	10 lbs.
12' Boom (4 nozzles)(40" spacing) .....	<b>DB12</b>	27 lbs.
18' Boom (6 nozzles)(40" spacing) .....	<b>DB18</b>	38 lbs.
21' Truss-T, Rear Cross-fold Boom (13 nozzles, spray tips not included) .....	<b>DB21TDF</b>	85 lbs.
28' Truss-T, Rear Cross-fold Boom (17 nozzles, spray tips not included) .....	<b>DB28TDF</b>	110 lbs.
30' Truss-T, Rear Cross-fold Boom (19 nozzles, spray tips not included) .....	<b>DB30TDF</b>	115 lbs.



**Accessories**

Hose Reel with 50' of 3/4" hose (less handgun) .....	<b>9428114</b>	20 lbs.
Lawn & Turf Gun with #3 nozzle .....	<b>25660-3</b>	1 lbs.
Boom Extender Kit (includes 2 XT020 tips) .....	<b>9428147</b>	8 lbs.





# 80 Gallon Sprayer

*A necessary  
sprayer for  
recreational  
areas and  
small pasture  
fields*

## FEATURES

- 80 gallon tank with sloped sump for better drainage, 5" fillwell, and 1 1/2" outlet.
- Gallon and liter markings on the tank.
- Agitation standard on all tanks.
- Special molded in baffling in bottom of tanks for better agitation.
- Pocket on top side of tank for extra chemical or fresh water jug.
- Rugged 12 gauge formed steel skid frame.
- Adjustable drawbar hitch and axles with 18 x 9.50 flotation tires on silver rims for trailer models.
- Lift kit to raise tongue height 3" is included.
- Electronic continuous duty motor, diaphragm pump with Viton® valves will deliver 5 GPM. Draws 9 amps at 20 PSI.
- 3.5 HP Briggs and Stratton engine with C4101 pump delivering 6 GPM at 2600 RPM and 50 PSI. 150 PSI max.
- 4 HP Honda with "Silver Cast" pump (XL4101).
- Hypro® 6 roller PTO pump (C6500D) will deliver 8 GPM at 540 RPM and 50 PSI. 150 PSI max.
- Hand gun with 15' hose (380RB).
- 80" spray boom with 2 nozzles (AN1.5), 12' spray boom with 4 nozzles and spring loaded boom break away or 18' boom with 6 nozzles.
- Rear mount fits category "1" three-point.
- Receiver model requires class 4 receiver hitch.
- 3-section plumbing available for 3-section 21' boom. PTO pump required.



**9464088**  
Rear mount with PTO pump



**9464072**  
Receiver hitch  
with 5 GPM  
electric pump

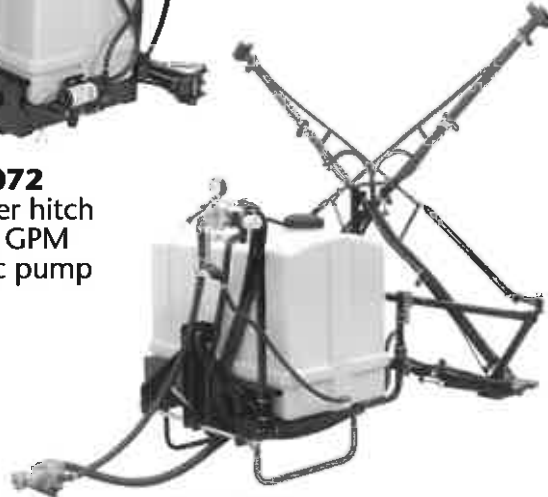

**9464090**  
Rear mount  
with PTO pump



**9464079**  
Trailer  
with 5 GPM  
electric pump



**HOW TO ORDER** Choose in this order: 1. Model 2. Boom 3. Accessories



**Model with Pump**

80 Gallon Skid with electric 5 GPM pump. Skid base is 26 1/2" wide x 34" deep. . . . .	<b>9464065</b>	138 lbs.
80 Gallon Skid with 3.5 HP B&S engine and C4101 pump Skid base is 26 1/2" wide x 34" deep. . . . .	<b>9464067</b>	181 lbs.
80 Gallon Skid with 4 HP Honda and "Silver Cast" pump (XL4101) Skid base is 26 1/2" wide x 34" deep. . . . .	<b>9464069</b>	181 lbs.
80 Gallon Receiver with electric 5 GPM pump . . . . .	<b>9464072</b>	159 lbs.
80 Gallon Receiver with 3.5 HP B&S engine and C4101 pump . . . . .	<b>9464074</b>	202 lbs.
80 Gallon Receiver with 4 HP Honda and "Silver Cast" pump (XL4101) . . . . .	<b>9464076</b>	202 lbs.
80 Gallon Trailer with electric 5 GPM pump . . . . .	<b>9464079</b>	202 lbs.
80 Gallon Trailer with 3.5 HP B&S engine and C4101 pump . . . . .	<b>9464081</b>	245 lbs.
80 Gallon Trailer with 4 HP Honda and "Silver Cast" pump (XL4101) . . . . .	<b>9464082</b>	245 lbs.
80 Gallon Rear Mount with electric 5 GPM pump . . . . .	<b>9464086</b>	165 lbs.
80 Gallon Rear Mount with PTO 6 roller pump for 80', 12', or 18' boom . . . . .	<b>9464088</b>	184 lbs.
80 Gallon Rear Mount with PTO 6 roller pump for 21', 28', or 30' boom (3-section) . . . . .	<b>9464090</b>	199 lbs.



**Boom with Plumbing**

80" Boom (2 nozzles)(40" spacing) . . . . .	<b>80B25</b>	10 lbs.
12' Boom (4 nozzles)(40" spacing) . . . . .	<b>DB12</b>	27 lbs.
18' Boom (6 nozzles)(40" spacing) . . . . .	<b>DB18</b>	38 lbs.
21' Truss-T, Rear Cross-fold Boom (13 nozzles, spray tips not included) . . . . .	<b>DB21TDF</b>	85 lbs.
28' Truss-T, Rear Cross-fold Boom (17 nozzles, spray tips not included) . . . . .	<b>DB28TDF</b>	110 lbs.
30' Truss-T, Rear Cross-fold Boom (19 nozzles, spray tips not included) . . . . .	<b>DB30TDF</b>	115 lbs.



**Accessories**

Hose Reel with 50' of 3/4" hose (less handgun) . . . . .	<b>9428114</b>	20 lbs.
Lawn & Turf Gun with #3 nozzle . . . . .	<b>25660-3</b>	1 lbs.
Boom Extender Kit (includes 2 XT020 tips) . . . . .	<b>9428147</b>	8 lbs.

# Accessories

for 40, 60, & 80 Gallon Pro Series Sprayers



9428114  
25660-3

Hose Reel with 50' of 3/8" hose (less handgun)  
Lawn & Turf Gun with #3 nozzle

## Booms

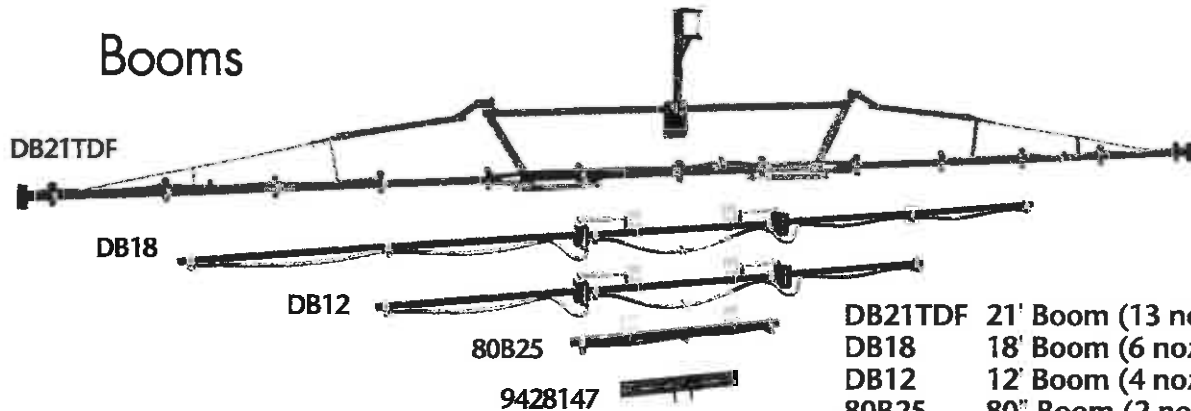

DB21TDF

DB18

DB12

80B25

9428147

DB21TDF 21' Boom (13 nozzles, 3-section)  
DB18 18' Boom (6 nozzles)  
DB12 12' Boom (4 nozzles)  
80B25 80" Boom (2 nozzles)  
9428147 Boom Extender

## Boom Extenders



Stainless Steel Polyacetal

Flow rates = .9-26.3 gpm at 30-60 psi



### X Tender Boom Nozzles for Broadcast Applications

Tip #	psi	gpm	swath* (ft)	Application Rate (GPM) at					
				3 mph	4 mph	5 mph	6 mph	8 mph	10 mph
XT020	30	1.732	17	16.6	12.6	10.1	8.4	6.3	5.0
	40	2.000	17	19.4	14.6	11.6	9.7	7.3	5.8
	50	2.236	17	21.7	16.3	13.0	10.9	8.1	6.5
	60	2.440	17	23.8	17.8	14.3	11.9	8.9	7.1
XT024	30	2.078	18	19.1	14.3	11.4	9.5	7.1	5.7
	40	2.400	18	22.0	16.5	13.2	11.0	8.3	6.6
	50	2.683	18	24.6	18.4	14.8	12.3	9.2	7.4
XT043	30	2.939	18	26.9	20.2	16.2	13.5	10.1	8.1
	40	3.724	18	38.4	28.8	23.0	19.2	14.4	11.5
	50	4.808	18	49.6	37.2	29.7	24.8	18.6	14.9
60	5.200	18	54.3	40.7	32.6	27.2	20.4	16.3	

\*All swaths and flow rates are based on tests conducted at 40 psi with nozzles parallel to the ground and 48-inches high while stationary.

Changes in spray height, operating pressure, mounting angle, and application speed will influence swath width.

- FCXT020 Hypro® Boom Extender  
17' swath (blue)
- FCXT024 Hypro® Boom Extender  
18' swath (yellow)
- FCXT043 Hypro® Boom Extender  
18' swath (orange)

# 110 & 150 Gallon Sprayer







## FEATURES

- 110 or 150 gallon polyethylene tank features sump, molded sight gauge and large fillwell with a no-splash fillwell cover. 5 GPM electric and gas engine roller pump units include agitation in tank.
- Heavy duty formed steel skid frame (W-30" x L-70").
- Electric motor, diaphragm pump with Viton® valves. Draws 9 amps @ 20 PSI (delivers 5 GPM). 35 PSI maximum pressure.
- Hypro® engine driven roller pump (C4101) delivers a max. 6.6 GPM at 2600 RPM (open flow). Max. pressure, 150 PSI.
- Hypro® engine driven centrifugal pump: Straight centrifugal pump. Pump delivers 94 GPM at 30 PSI. Maximum pressure is 70 PSI.
- Ace engine driven centrifugal pump delivers 19 GPM max. and 40 PSI max. with 3.5 HP Briggs & Stratton engine.
- 18" handgun with 15' hose (380RB).
- 12' and 18' booms feature floodjet tips (AN1.5 with 40' nozzle spacing) and spring loaded boom wing breakaway.
- 21' and 28' Truss-T boom features vertical and horizontal boom breakaway with 20" nozzle spacing. Spray tips are not included. 10 GPA maximum output when used with electric pump.



**Optional  
Lawn & Turf  
Handgun**

**HOW TO ORDER** Choose in this order: 1. Tank 2. Frame 3. Plumbing 4. Engine 5. Pump 6. Boom 7. Accessories

	<b>Tank</b>		
	110 Gallon Tank with agitation .....	<b>P110 24A</b>	40 lbs.
	150 Gallon Tank with agitation .....	<b>P150 30A</b>	50 lbs.
	<b>Frame</b>		
	110 Gallon Skid Frame .....	<b>9464035</b>	105 lbs.
	150 Gallon Skid Frame .....	<b>9464036</b>	110 lbs.
	<b>Plumbing</b>		
	5 GPM Electric pump plumbing kit (pump included) .....	<b>9465008</b>	10 lbs.
	4 Roller Pump Plumbing Kit (1 Section) (engine/pump not included) .....	<b>SMR</b>	36 lbs.
	4 Roller Pump Plumbing Kit (3 Section) (engine/pump not included) .....	<b>SMR3</b>	36 lbs.
	Centrifugal Plumbing Kit (1 Section) (engine/pump not included) .....	<b>9465009</b>	36 lbs.
	Centrifugal Plumbing Kit (3 Section) (engine/pump not included) .....	<b>9465010</b>	36 lbs.
	<b>Engines</b>		
	3.5 HP B&S .....	<b>GE3HP</b>	28 lbs.
	4 HP Honda .....	<b>GH4HP</b>	30 lbs.
	3.5 HP B&S with centrifugal pump .....	<b>DAC135</b>	28 lbs.
	3 HP Honda with centrifugal pump .....	<b>DAC135H</b>	28 lbs.
	5 HP B&S with centrifugal pump .....	<b>DHC155</b>	53 lbs.
	5.5 HP Honda with centrifugal pump .....	<b>DHC155H</b>	65 lbs.
	<b>Pumps</b>		
	4 Roller Pump .....	<b>C4101</b>	5 lbs.
	4 Roller "Silver Cast" Pump .....	<b>XL4101</b>	5 lbs.
	<b>Boom with Plumbing</b>		
	12' Boom (4 Nozzles)(40" spacing)(1 Section) .....	<b>DB12</b>	27 lbs.
	18' Boom (6 Nozzles)(40" spacing)(1 Section) .....	<b>DB18</b>	38 lbs.
	21' Truss-T Boom (13 Nozzles) (3 Section) .....	<b>DB21T</b>	85 lbs.
	28' Truss-T Boom (17 Nozzles) (3 Section) .....	<b>DB28T</b>	110 lbs.
	<b>Accessories</b>		
	Hose Reel with 100' of 1/2" Hose. Reel will hold 200' .....	<b>9428035</b>	90 lbs.
	Lawn and Turf Handgun .....	<b>25660-3</b>	1 lbs.
	1/2" Rubber Hose .....	<b>120RB</b>	per foot

# 150 & 200 Gallon ATV Sprayer

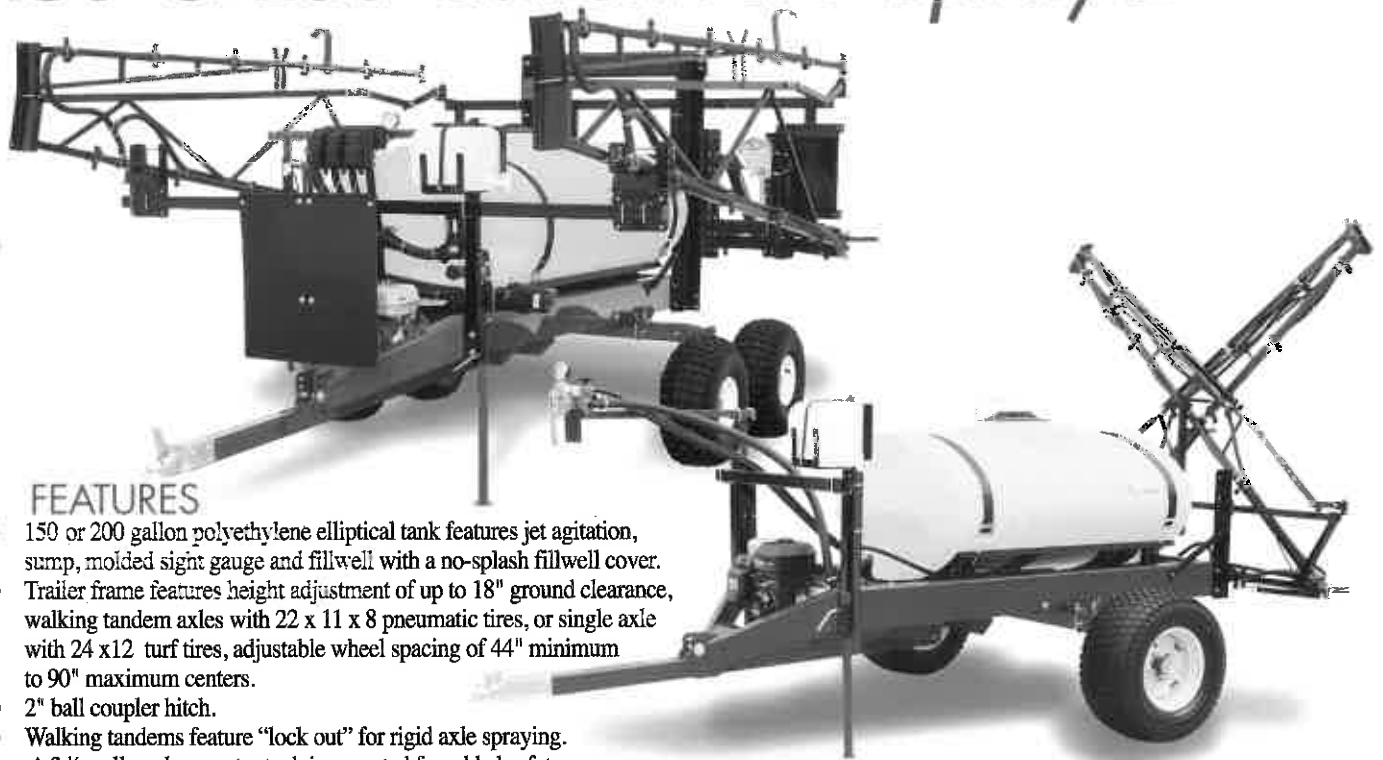

## FEATURES

- 150 or 200 gallon polyethylene elliptical tank features jet agitation, sump, molded sight gauge and fillwell with a no-splash fillwell cover.
- Trailer frame features height adjustment of up to 18" ground clearance, walking tandem axles with 22 x 11 x 8 pneumatic tires, or single axle with 24 x12 turf tires, adjustable wheel spacing of 44" minimum to 90" maximum centers.
- 2" ball coupler hitch.
- Walking tandems feature "lock out" for rigid axle spraying.
- A 2 1/2 gallon clean water tank is mounted for added safety.
- PTO driven roller pump: Hypro® cast iron 6 roller pump (C6500D) delivers a maximum of 9.7 GPM at 540 RPM (open flow).
- Hypro® engine driven centrifugal pump: Straight centrifugal pump. Pump delivers 94 GPM at 30 PSI. Maximum pressure is 70 PSI.
- Demco's 21', 28', 30' and 40' Truss-T booms feature horizontal and vertical break-away hinges and 1/2" rubber hose with no-drip diaphragm check nozzles spaced at 20". 8' transport width.
- 45' truss boom features horizontal and vertical break-away hinges and auto level ride, 3/4" rubber hose with diaphragm check nozzles spaced at 20". 8' 7" transport width.

Note: Sprayer is less spray tips. Factory set up is available.

**HOW TO ORDER** Choose in this order: 1. Tank/Trailer Frame Assembly with Tires 2. Pump and Plumbing 3. Controls 4. Boom 5. Accessories



### Tank/Trailer Frame Assembly

150 Gallon Tandem Axle Tank and Trailer Assembly .....	<b>9464055</b>	580 lbs.
200 Gallon Tandem Axle Tank and Trailer Assembly .....	<b>9464056</b>	610 lbs.
150 Gallon Single Axle Tank and Trailer Assembly .....	<b>9464058</b>	545 lbs.
200 Gallon Single Axle Tank and Trailer Assembly .....	<b>9464059</b>	75 lbs.



### Pumps and Plumbing Kit

5 HP B&S Gas Engine with Centrifugal Pump and Plumbing Kit .....	<b>9970400</b>	75 lbs.
5.5 HP Honda Gas Engine with Centrifugal Pump and Plumbing Kit .....	<b>9465029</b>	75 lbs.
PTO Mounted 6 Roller Pump and Plumbing Kit .....	<b>9970100</b>	35 lbs.
PTO Mounted 6 Roller "Silver Cast" Pump and Plumbing Kit .....	<b>9465025</b>	35 lbs.



### Controls

Manual Control Valves .....	<b>9465037</b>	5 lbs.
Electric Solenoid Control Valves .....	<b>9465038</b>	15 lbs.
TeeJet® 844E Sprayer Control with Ball Valves .....	<b>9428105</b>	15 lbs.
Raven® 440 Sprayer Control with Ball Valves .....	<b>9428106</b>	15 lbs.



### Boom with Plumbing

NOTE: Order Spray Tips separately.

21' Truss-T, Rear Cross-fold Boom .....	<b>DB21TDF</b>	85 lbs.
28' Truss-T, Rear Cross-fold Boom .....	<b>DB28TDF</b>	110 lbs.
30' Truss-T, Rear Cross-fold Boom .....	<b>DB30TDF</b>	115 lbs.
40' Truss-T, Rear Cross-fold Boom .....	<b>DB40TDF</b>	170 lbs.
45' Truss Front-fold Boom with auto ride and manual height adjuster .....	<b>9488100</b>	95 lbs.



### Accessories

Hose Reel with 100' of 1/2" Hose. Reel will hold 200' (Handgun included) .....	<b>DHR</b>	95 lbs.
Engine Mud Guard .....	<b>9428131</b>	
Factory Setup (Boom may be removed for shipping) .....	<b>SU157</b>	
Handgun .....	<b>DBHGL</b>	13 lbs.
Foam Marker .....	<b>DFM30</b>	113 lbs.
Fence Line Spray Kit, Manual .....	<b>9428003</b>	5 lbs.
1/2" Rubber Hose .....	<b>12ORB</b>	per foot

# 150 & 200 Gallon RM Sprayer

## Rear Mount Units

### FEATURES

- 150 or 200 gallon tank with jet agitation, molded sight gauge, sump, fillwell with no-splash cover.
- Rear mount brackets are complete with saddles, tank bands and all necessary bolts.
- Rear mount brackets will fit categories "1" and "2".
- Unit may be used with a "Quick Attach" three point hookup.
- Non-retractable built-in ground stand for storage when empty.
- Hypro® 8 roller PTO pump (C7560D) will deliver 22 GPM at 1000 RPM, 12 GPM at 540 RPM and 300 PSI max.
- 21', 28', 30' and 40' Truss-T booms feature vertical and horizontal boom breakaway, no drip diaphragm check nozzles spaced at 20".
- Handgun with 25' of hose (optional)

NOTE: LTL freight shipments require \$60.00 crating charge.









Three section electric solenoid valve and control



BoomJet® nozzle

**HOW TO ORDER** Choose in this order: 1. Frame 2. Tank 3. Boom 4. Pump and Plumbing 5. Controls 6. Accessories

	<b>Frame</b>		
	Rear Mount Frame for 150 gallon tank .....	<b>9416006</b>	190 lbs.
	Rear Mount Frame for 200 gallon tank .....	<b>9416007</b>	200 lbs.
	<b>Tank</b>		
	150 Gallon Tank with agitation .....	<b>P150 32A</b>	50 lbs.
	200 Gallon Tank with agitation .....	<b>P200 32A</b>	64 lbs.
	<b>Boom with Plumbing</b> <i>Note: Order Spray Tips separately.</i>		
	21' Boom (3 section, 13 nozzles) .....	<b>DB21TDF</b>	85 lbs.
	28' Boom (3 section, 17 nozzles) .....	<b>DB28TDF</b>	110 lbs.
	30' Boom (3 section, 19 nozzles) .....	<b>DB30TDF</b>	115 lbs.
	40' Boom (3 section, 25 nozzles) .....	<b>DB40TDF</b>	170 lbs.
	BoomJet® Nozzle Bracket Kit (1 section, nozzle not included) .....	<b>9464050</b>	5 lbs.
	<b>Pumps and Plumbing Kit</b> (less controls)		
	PTO Mounted 8 Roller Pump and Plumbing Kit (1 section) .....	<b>9465064</b>	28 lbs.
	PTO Mounted 8 Roller "Silver Cast" Pump and Plumbing Kit (1 section) .....	<b>9465065</b>	28 lbs.
	PTO Mounted 8 Roller Pump and Plumbing Kit (3 section) .....	<b>9465066</b>	31 lbs.
	PTO Mounted 8 Roller "Silver Cast" Pump and Plumbing Kit (3 section) .....	<b>9465067</b>	31 lbs.
	Centrifugal Pump Plumbing Kit (3 section) (Pump not included) .....	<b>9465068</b>	65 lbs.
	<b>Controls</b>		
	Manual (1 section) .....	<b>9465054</b>	2 lbs.
	Electric (1 section) .....	<b>9465055</b>	5 lbs.
	Manual (3 section) .....	<b>9465056</b>	5 lbs.
	Electric (3 section) .....	<b>9465057</b>	15 lbs.
	<b>Accessories</b>		
	Handgun (includes 25' of ½" hose) .....	<b>DBHGR</b>	13 lbs.
	Factory Setup (Booms may be removed for shipping.) .....	<b>SURMU</b>	

# Dethmers Manufacturing

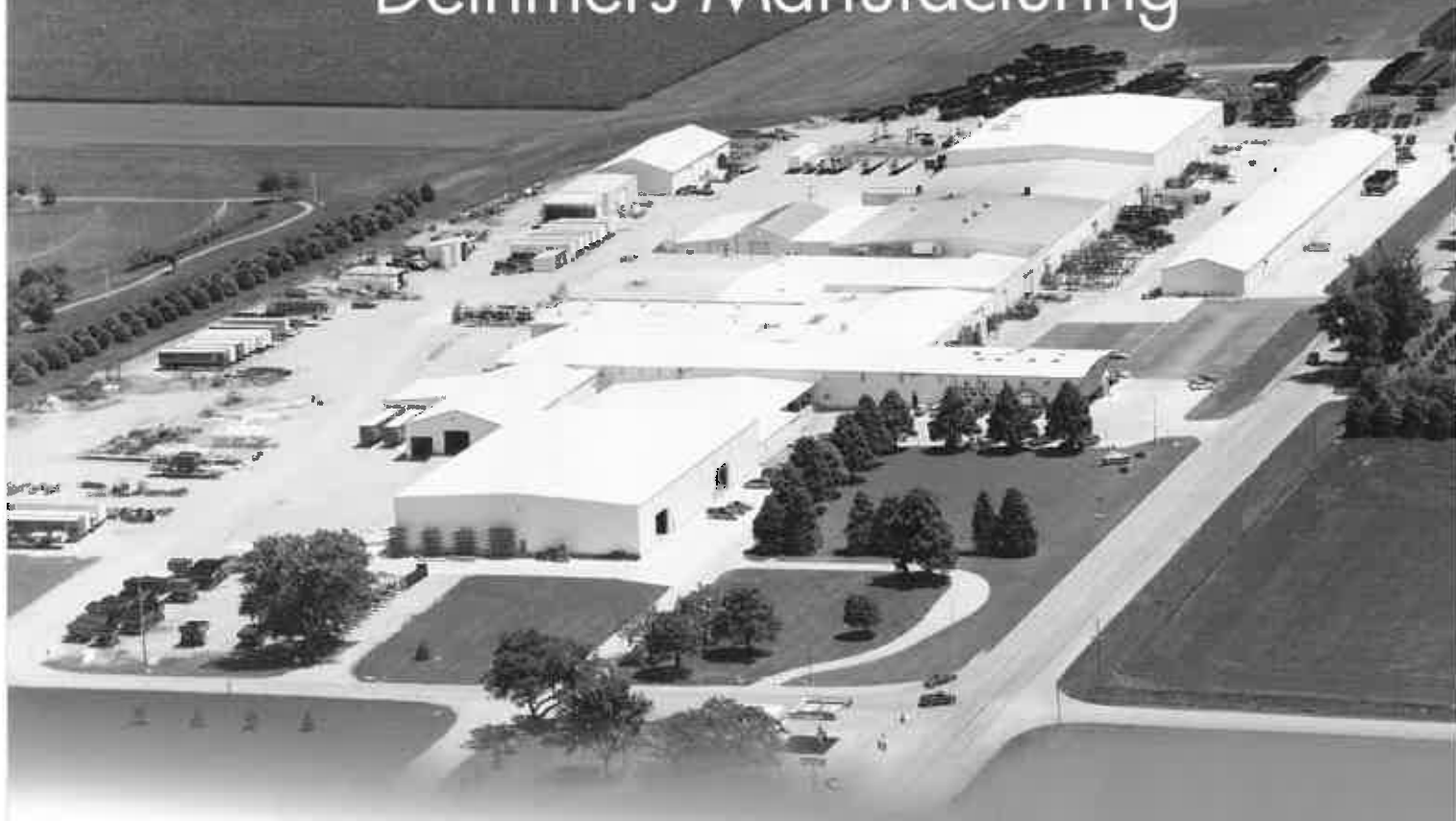

## We've been time tested and proven...

Back in 1950, Robert Dethmers started Dethmers Manufacturing Company in a corner of an implement dealership. One of his first products was fertilizer application equipment for the agricultural industry.

Today, as Demco continues to grow, our tradition of building quality products, employing talented, industrious people and providing attentive service remains. Our sales staff along with our dealers and distributors across the United States, Canada and the world carry on the standard.

Meeting the challenges and opportunities of changing times has produced growth in product lines. Our products are engineered and constructed with the best of materials and the latest in manufacturing technology, then tested beyond recommendations, pushing the product to its limit before the Demco name goes on. Our reputation was built on quality and dependability and we continue by being tougher on the product than the consumer.

Demco is committed to give its customers quality products tailored to meet their needs.



***Dethmers Manufacturing Company***

P.O. Box 189 • 4010 320th Street • Boyden, Iowa 51234  
(712)725-2311 • 1-800-543-3626 • FAX: 1-800-845-6420

View all Demco products on the web at: [www.demco-products.com](http://www.demco-products.com)

***DOING OUR BEST TO PROVIDE YOU THE BEST***



# Demco

## 2015 Sprayer Catalog

Doing Our Best to Provide You the Best

[www.demco-products.com](http://www.demco-products.com)

500 Gallon Sprayer

Page 7

110 Gallon Sprayer

Page 6

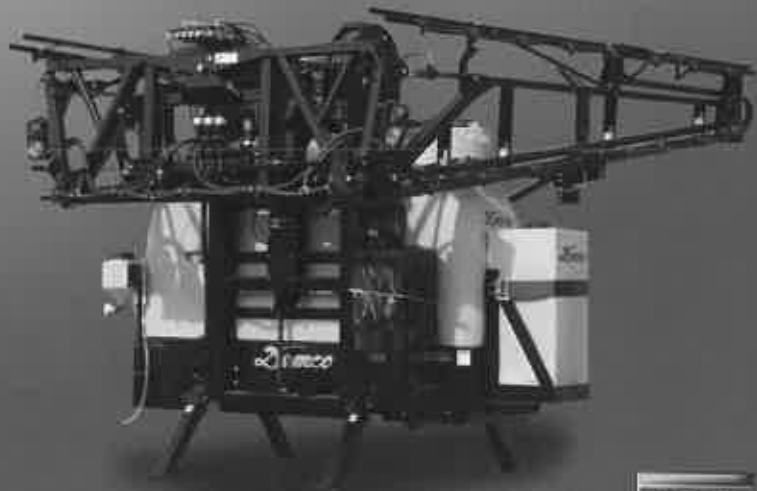

Demco / MAURER  
MANUFACTURING

Affiliated since 2000





## LAWN & GARDEN SPRAYERS

14 Gallon .....	1
25 Gallon .....	2
40 Gallon .....	3
60 Gallon .....	4
80 Gallon .....	5
110/150 Gallon .....	6
150/200 Gallon .....	7

## FIELD SPRAYERS

300 Gallon .....	8-9
500 Gallon .....	10-11
850-45, 60, 66' .....	12-13
1050-45, 60, 66' .....	14-15
1050-80/90' .....	16-17
1250-80/90' .....	18-19
SideQuest® 1200 Gallon-80/90' .....	20-21

## TRACTOR MOUNTED SPRAYERS

Tractor mount Quick Fit List .....	22-25
SideQuest® Side Mounts 1200 Gallon .....	26
SideQuest® Side Mounts 700 & 1000 Gallon .....	27-28
SideQuest® Side Mounts 1200 Gallon .....	29
Side Mounts "Quick Tach" 400 & 500 Gallon .....	30-32
Rear Mount 600 Gallon .....	33
Rear Mount 300, 400 & 500 Gallon .....	34
Rear Mount 150 & 200 Gallon .....	35

## BOOMS

Booms (80', 12' & 18') .....	36
Truss-T Booms (21', 30' & 40') .....	36
Truss Booms (28', 30' & 45') .....	37
Manual Fold Floating Booms (45' & 60') .....	38
Hydraulic X-Fold Booms (45' & 60') .....	39

## FERTILIZER EQUIPMENT

Lil' Thumper Piston Pumps .....	40-41
Piston Pumps Parts .....	42-43

## COMPONENTS

Tanks & Saddles .....	44-45
Tank Accessories .....	46
Foam Markers .....	47
Chemical Loading Devices .....	47
Sprayer Controls .....	48-49
Pumps .....	50-53
Parts .....	54-58
Spray Nozzle Accessories .....	59-63



Dear Customer,

Over the years we've been printing catalogs to help customers like you purchase quality Demco products. Every item in this catalog reflects our commitment to quality, durability, efficiency and value.

Our new 2015 Farm Equipment Catalog is specifically designed to help you configure and price items and to avoid much of the confusion related to choosing features available on specific implement models. You'll find an ordering procedure (gray header bar) at the top of each chart to help you gather all the features you need to make a successful and hassle free order.

If you have any questions on availability or compatibility to your application, call us at **1-800-543-3626**. We'll be glad to answer any questions. We're committed to your full satisfaction. It's just part of ...

*"Doing our best to provide you the best".*

The Demco logo, featuring the word "Demco" in a stylized, cursive font with a shadow effect.

# Special Information

## PRICES & SPECIFICATIONS

All prices and specifications are subject to change without notice. All shipments are billed at price prevailing at time of shipments. ALL PRICES F.O.B. BOYDEN, IOWA OR AS DESIGNATED IN THIS CATALOG.

## TERMS

Concerns desiring credit must have good rating or furnish satisfactory reference before shipment will be made, otherwise all orders will be shipped C.O.D. No cash discounts allowed with C.O.D. shipments.

## ORDERING

All accounts must contact their area distributor. If your business is not located in a distributor area please call us direct. Please furnish credit and bank references with your first order.

## SHIPMENTS

Our merchandise is carefully packed and thoroughly inspected before leaving our factory. Responsibility for its safe delivery is assumed by the carrier upon acceptance of the shipment. Claims for loss or damage sustained in transit must therefore be made upon the delivering carrier as follows:

**CONCEALED LOSS OR DAMAGE** - Concealed loss or damage means loss or damage which does not become apparent until the merchandise has been unpacked. The contents may be damaged in transit due to rough handling even though the carton may not show external damage. When the damage is discovered upon unpacking, make a written request for inspection by the carrier's agent within 15 days of the delivery date. Then file a claim with the carrier, since such damage is the carrier's responsibility.

**VISIBLE LOSS OR DAMAGE** - Any external evidence of loss or damage must be noted on the freight bill or express receipt, and signed by the carrier's agent. Failure to adequately describe such external evidence of loss or damage may result in the carrier refusing to honor a damage claim. The form required to file a claim will be supplied by the carrier.

## SHIPPING ERRORS

Shipping errors resulting in shortages or goods ordered incorrectly by the customer, must be reported to Dethmers Manufacturing Company within 10 days after receipt of merchandise.

## PICK UP ORDERS

All orders picked up and signed for by the customer or customer's agent at the Boyden, Iowa plant are considered complete as signed. Customer will receive a copy of signed order at time of loading.

## PARCEL POST, U.P.S., FEDERAL EXPRESS & FREIGHT

Due to the special packing and handling on Parcel Post and United Parcel shipments, a combined shipping and handling fee will be charged on each carton. Weight limitations are as follows:

Parcel Post = 70 lbs.

UPS = 150 lbs.

Federal Express = 150 lbs. - per carton.

A pallet charge is added on all freight orders.

## RETURNS

NO GOODS ARE TO BE RETURNED TO THE DISTRIBUTOR OR DEMCO WITHOUT A RETURNED GOODS AUTHORIZATION NUMBER AND INVOICE NUMBER. When your order has been filled correctly, the concerned party returning goods must in all cases pay freight, the cost of handling and a 25% restocking charge. All goods to be returned are to be in first class condition. Additional charges will be made for goods returned in other than first class condition.

© 2015 Dethmers Mfg Co.

*Demco has attempted to show each and every product in this catalog in an accurate manner, yet, because we are continually "Doing Our Best to Provide You the Best," product and/or production enhancements may sometimes change the appearance of an item before new photos can be taken.*

*Demco is not responsible for typographical errors.*

Banjo is a registered trademark of Banjo Corporation. Roundup is a registered trademark of Monsanto. TeeJet, FloodJet, Al TeeJet and BoomJet are registered trademarks of Spraying Systems Co. Viton and Rynite are registered trademarks of E. I. du Pont de Nemours and Company or its affiliates. du Pont is a trademark of E. I. du Pont de Nemours and Company or its affiliates. Raven is a registered trademark of Raven Industries Inc. Hypro is a registered trademark of Hypro. LLC. Cleanload is a trademark of Hypro. LLC. PowerPro is a trademark of Hypro. LLC. AGCO, Massey Ferguson and Challenger are registered trademarks of AGCO Corporation. Cat is a registered trademark of Caterpillar Inc. John Deere is a registered trademark of Deere & Company. IVT is a trademark of Deere & Company. ILS is a trademark of Deere & Company. Case IH, New Holland and Maxum are registered trademarks of CNH America LLC. Magnum & SuperSteer are a trademark of CNH America LLC. SAFI is a registered trademark of SAFI SAS. UltraFlyte™ is a trademark of Cadorath Unifyte. Honda is a registered trademark of Honda Motor Co., Ltd.



Doing Our Best to Provide You the Best

Sage  
Brush  
Buyers  
306-741-6678

**Scott Scherbring**

*Territorial Manager*

*Cell phone: 507-272-5950*

*E-mail: scott.scherbring@demco-products.com*



**General Implement Distributors**

**801-972-4321**

**Northwest 94 Sales Inc**

**503-390-5356**

**Floyd Lilly**

**208-733-1240**

**Ed Stoel**

*Territorial Manager*

*Cell phone: 507-220-3312*

*E-mail: ed.stoel@demco-products.com*



**Chris Currans**

*Territorial Manager*

*Cell phone: 515-708-1147*

*E-mail: chris.currans@demco-products.com*



**Solex**

**707-678-5533**

**Larry Kann**

*Territorial Manager*

*Cell phone: 309-824-2836*

*E-mail: larry.kann@demco-products.com*



**Brian Tonniges**

*Territorial Manager*

*Cell phone: 308-390-1400*

*E-mail: brian.tonniges@demco-products.com*



**Denny Menefee**

*Territorial Manager*

*Cell phone: 812-593-4589*

*E-mail: denny.menefee@demco-products.com*

**Grant  
Howse**  
204-721-1998

**DFK Equipment Sales**  
519-349-2080

**West Country Products**  
701-251-2182

**J S  
Woodhouse  
Company Inc**  
315-463-5201

**Farmgo**  
517-669-8391

**Hamilton  
Equipment  
Inc**  
717-733-7951

**Pete Kimball  
Sales**  
800-548-2529

**Harper Marketing**  
620-874-0530

**Short Line  
Sales**  
901-942-0224

**Implement Sales LLC**  
770-908-9439

**Cooper's Sales Inc.**  
580-641-1420



# INSIDE SALES SUPPORT STAFF

If you have questions about Demco Products . . .

## We have the answers

Our *Inside Sales Support Staff* has the experience and knowledge to help guide you through purchasing decisions with complete and accurate information.

When it comes to questions about Demco Products . . .  
*we have the answers.*

Call us: **800-543-3626**

Or e-mail us: **[sales@demco-products.com](mailto:sales@demco-products.com)**



**Ken Streff**  
*VP Sales and Marketing*



**Jared Klingenberg**  
*Sales*

**Kevin Rosenboom**  
*Sales*

**Daryl Grooters**  
*Trailer Components and Rental Sales*

**Troy Woelber**  
*Sales*

**Scott Johnsen**  
*RV Sales*

**Kenny Kruse**  
*Sales*

**Jerry Sandbulte**  
*Ag Lawn and Garden Sales*

**Bob Netten**  
*Ag Sales*

**Benji Vande Griend**  
*Ag Products Sales Manager*

# Demco

Doing Our Best to Provide You the Best



**Ardell Niemeyer**  
*Shipping Supervisor*

# 14 Gallon PRO SERIES



**SM314  
HYMB  
80B10**



**SM314**

## Features

- 14 gallon tank with 5" fillwell and 1/2" outlet.
- Two formed steel channels bolt directly to the bottom of the tank. The rear bracket is used for the boom installation.
- 15" spray gun with adjustable nozzle. 15' lead hose (380RB).
- 12 volt continuous duty motor with a diaphragm pump with Viton® valves. Draws 4.7 amps @ 30 PSI (SM14 - 1.8 GPM)(SM314 - 3 GPM).
- 3 GPM pump includes pressure gauge and regulator.
- 80" spray boom with 2 nozzles.
- 144" spray boom with 4 nozzles has spring loaded boom breakaway.
- Two booms available, all with spray nozzles and height adjustment to get correct spray pattern overlap.

*NOTE: All 14 gallon sprayers are partially preassembled.*

**HOW TO ORDER** 1. Choose desired **Sprayer/Pump Model** 2. Choose appropriate **Accessories**



**Model and Pump**

14 Gallon Skid Mount, No Boom, 1.8 GPM electric pump .....	<b>SM14</b>	38 lbs.	\$475.00
14 Gallon Skid Mount, No Boom, 3 GPM electric pump, pressure gauge & regulating valve .....	<b>SM314</b>	43 lbs.	\$597.00



**Accessories**

Universal Mounting Brackets for ATV cargo rack .....	<b>HYMB</b>	2 lbs.	\$56.00
80" Two Nozzle Boom Assembly (40" spacing) .....	<b>80B10</b>	15 lbs.	\$138.00
144" Four Nozzle Boom Assembly (40" spacing) .....	<b>144B14</b>	33 lbs.	\$310.00
Tank, Frame, Mounting Brackets and Plumbing for two tank hookup on one ATV .....	<b>EX14KT</b>	30 lbs.	\$235.00

# 25 Gallon PRO SERIES

Lawn & Garden

HAMILTON

## Features

- 25 gallon tank with 5" fillwell and 1/2" outlet with agitation.
- Electric motor with a diaphragm pump and Viton® valves. Draws 9 amps @ 20 PSI (delivers 5 GPM). 35 PSI maximum spraying pressure.
- Heavy duty tube steel welded frame fits most ATV's. Tie down straps make mounting easy.
- 18" handgun with adjustable nozzle. 15' lead hose.
- Plumbing includes pressure gauge & regulator.
- 12' and 18' booms feature floodjet tips and spring loaded boom wing breakaway. 10 GPA at 4 MPH output.
- 21', 28' or 30' Truss-T booms feature vertical and horizontal boom breakaway with 20" nozzle spacing.



9464047  
DB12

Note: Do not exceed manufacturer's load limit.

Note: All 25 gallon ATV sprayers are partially preassembled.



9464047  
DB30TDF  
EX14KT

### HOW TO ORDER 1. Choose desired **Sprayer/Pump Model** 2. Choose appropriate **Boom** 3. Choose appropriate **Accessories**



#### Model and Pump

25 Gallon rear ATV Mount, 5 GPM electric pump, pressure gauge & regulating valve ..... **9464047** 74 lbs. \$872.00



#### Boom with Plumbing

12' Boom (1 section)(4 nozzles)(40" spacing) ..... **DB12** 27 lbs. \$252.00

18' Boom (1 section)(6 nozzles)(40" spacing) ..... **DB18** 38 lbs. \$355.00

21' Truss-T boom (1 section)(13 nozzles) *See Components Section for tips* ..... **DB21TDF** 85 lbs. \$1,029.00

30' Truss-T boom (1 section)(19 nozzles) *See Components Section for tips* ..... **DB30TDF** 115 lbs. \$1,288.00



#### Accessories

25 Gallon front tank with agitation, frame, mounting bracket and plumbing for two tank hookup on one ATV ..... **9464048** 40 lbs. \$288.00

14 Gallon front tank with frame, mounting bracket and plumbing for two tank hookup on one ATV ..... **EX14KT** 30 lbs. \$235.00

# 40 Gallon PRO SERIES

9464077  
80B25

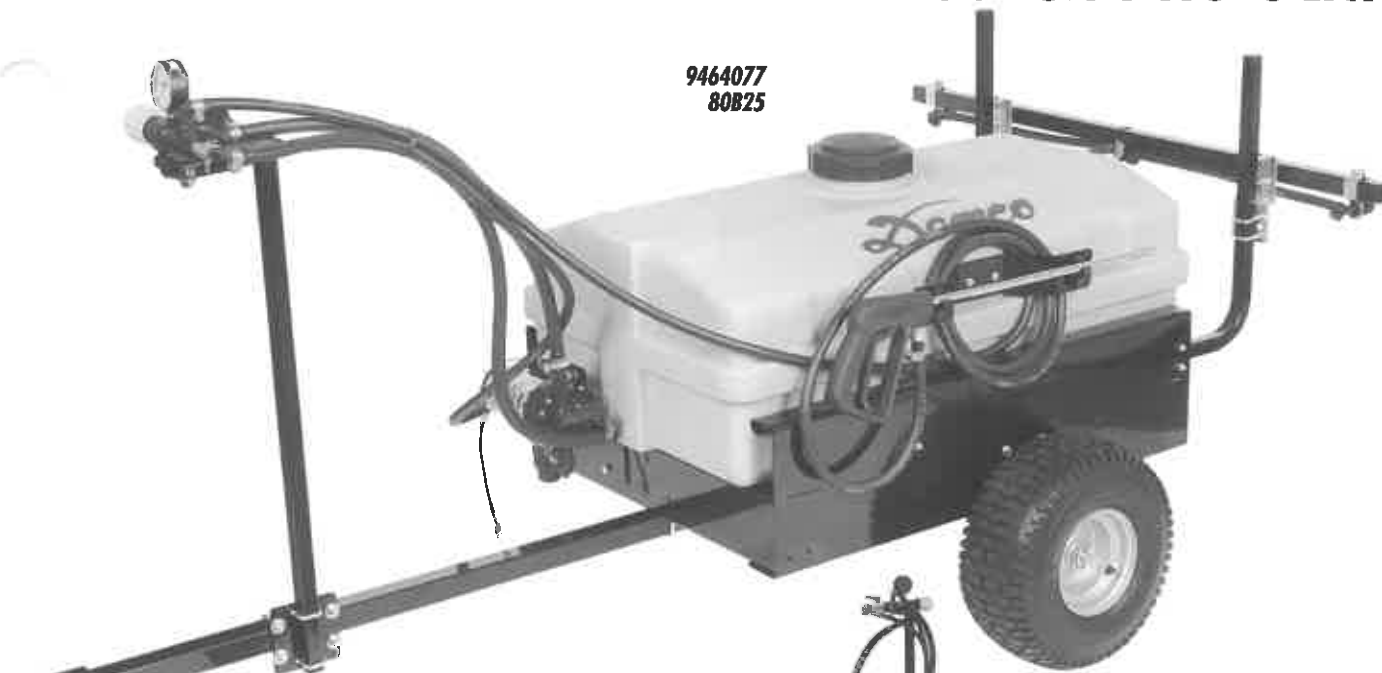

9464063  
80B25



9464084  
DB12

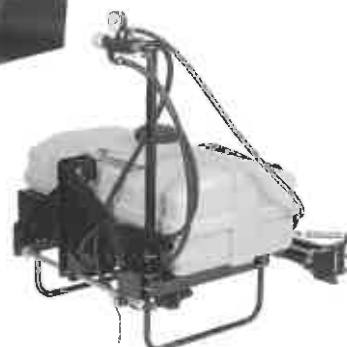

## Features

- 40 gallon tank with a sloped bottom sump for total drainage, 5" fillwell, and 1 1/4" outlet.
- Gallon and liter markings on the tank.
- Agitation is standard on all tanks.
- Special molded-in baffling in bottom of tank for enhanced agitation.
- Rugged 12 gauge formed steel skid frame.
- Bolt on tongue and axle with 15 x 6 flotation turf tires on silver rims for trailer models.
- Pressure regulator.
- Electric motor, diaphragm pump with Viton® valves. Draws 9 amps @ 20 PSI (delivers 5 GPM).
- Handgun with 15' spray hose (380RB).
- 80" spray boom with 2 nozzles (AN1.5). 12' boom with 4 nozzles and spring loaded boom breakaway or 18' boom with 6 nozzles.
- Skid dimensions 26.5" wide x 34" long x 21" high.
- Rear mount fits category "1" three-point.

NOTE: All 40 gallon sprayers are partially preassembled.

### HOW TO ORDER Choose in this order: 1. Model 2. Boom 3. Accessories



#### Model and Pump

40 gallon skid mount with 5 GPM electric pump. Skid base is 26 1/2" wide x 34" deep. ....	<b>9464063</b>	112 lbs.	\$1,090.00
40 gallon trailer with 5 GPM electric pump .....	<b>9464077</b>	154 lbs.	\$1,285.00
40 gallon rear mount with 5 GPM electric pump .....	<b>9464084</b>	139 lbs.	\$1,148.00



#### Boom with Plumbing

80' Boom (2 nozzles)(40" spacing) .....	<b>80B25</b>	10 lbs.	\$116.00
12' Boom (4 nozzles)(40" spacing) .....	<b>DB12</b>	27 lbs.	\$252.00
18' Boom (6 nozzles)(40" spacing) .....	<b>DB18</b>	38 lbs.	\$355.00
2 Nozzle Boomless Kit (includes 2 FC-XT010 tips, sprays approximately 30') .....	<b>9428147</b>	8 lbs.	\$250.00



#### Accessories

Hose Reel with 50' of 3/8" hose (uses existing handgun) .....	<b>9428114</b>	20 lbs.	\$229.00
Lawn & turf gun with #3 nozzle .....	<b>25660-3</b>	1 lbs.	\$124.00
LTL freight shipments require crating .....	<b>CRATE</b>		Net. \$58.00



# 60 Gallon PRO SERIES



## Features

- 60 gallon tank with a sloped bottom sump for total drainage, 5" fillwell, and 1 1/4" outlet.
- Gallon and liter markings on the tank.
- Agitation is standard on all tanks.
- Special molded-in baffling in bottom of all tanks for enhanced agitation.
- Pocket on top side of tank to hold two 1 gallon jugs or one 2 1/2 gallon jug for chemical or fresh water.
- Rugged 12 gauge formed steel skid frame.
- 18 x 9.50 flotation tires on silver rims for trailer models.
- Electric motor, diaphragm pump with Viton® valves will deliver 5 GPM. Draws 9 amps at 20 PSI.
- 3 HP Honda® engine with centrifugal pump will deliver 12 GPM @ 50 PSI - 65 PSI maximum pressure. Fertilizer and Roundup® ready compatible.
- 3.5 HP Briggs and Stratton engine with C4101GE pump delivering 6.6 GPM at 2600 RPM and 50 PSI. 150 PSI max.
- 4 HP Honda® with 4 roller "Silver Cast" pump (XL4101).
- Hypro® 6 roller PTO pump (C6500D) will deliver 8 GPM at 540 RPM and 50 PSI. 150 PSI max.
- Handgun with 15' hose (380RB).
- 30" spray boom with 2 nozzles (AN1.5), 12' spray boom with 4 nozzles and spring loaded boom breakaway or 18' boom with 6 nozzles.
- Skid dimensions 26.5" wide x 34" long x 30" high.
- Receiver model requires class 4 receiver hitch.

NOTE: All 60 gallon sprayers are partially preassembled.



9428114  
Hose reel

### HOW TO ORDER Choose in this order: 1. Model 2. Boom 3. Accessories



#### Model with Pump

60 Gallon Skid with electric 5 GPM pump. Skid base is 26 1/2" wide x 34" deep. ....	<b>9464064</b>	122 lbs.	\$1,173.00
60 Gallon Skid with 3.5 HP B&S engine and C4101GE pump Skid base is 26 1/2" wide x 34" deep. ....	<b>9464066</b>	165 lbs.	\$1,750.00
60 Gallon Skid with 4 HP Honda® and "Silver Cast" pump (XL4101) Skid base is 26 1/2" wide x 34" deep. ....	<b>9464068</b>	165 lbs.	\$2,380.00
60 Gallon Skid with Ace centrifugal pump and 3 HP Honda® engine (1-section). ....	<b>9464101</b>	165 lbs.	\$2,317.00
60 Gallon Skid with Ace centrifugal pump and 3 HP Honda® engine (3-section). ....	<b>9464096</b>	165 lbs.	\$2,530.00
60 Gallon Trailer with electric 5 GPM pump. ....	<b>9464078</b>	186 lbs.	\$1,501.00
60 Gallon Trailer with 3.5 HP B&S engine and C4101GE pump. ....	<b>9464080</b>	229 lbs.	\$2,073.00
60 Gallon Trailer with 4 HP Honda® and "Silver Cast" pump (XL4101). ....	<b>9464082</b>	229 lbs.	\$2,703.00
60 Gallon Trailer with Ace centrifugal pump and 3 HP Honda® engine (1-section). ....	<b>9464105</b>	165 lbs.	\$2,646.00
60 Gallon Trailer with Ace centrifugal pump and 3 HP Honda® engine (3-section). ....	<b>9464103</b>	165 lbs.	\$2,856.00
60 Gallon Rear Mount with electric 5 GPM pump. ....	<b>9464085</b>	149 lbs.	\$1,223.00
60 Gallon Rear Mount with PTO 6 roller pump for 80', 12', or 18' boom (1-section). ....	<b>9464087</b>	168 lbs.	\$1,406.00
60 Gallon Rear Mount with PTO 6 roller pump for 21', 28', or 30' boom (3-section). ....	<b>9464089</b>	183 lbs.	\$1,615.00



#### Boom with Plumbing

80' Boom (2 nozzles)(40" spacing)(1-section) .....	<b>80B25</b>	10 lbs.	\$116.00
12' Boom (4 nozzles)(40" spacing)(1-section) .....	<b>DB12</b>	27 lbs.	\$252.00
18' Boom (6 nozzles)(40" spacing)(1-section) .....	<b>DB18</b>	38 lbs.	\$355.00
2 Nozzle Boomless Kit Electric Pump (sprays approximately 30') .....	<b>9428147</b>	8 lbs.	\$250.00
2 Nozzle Boomless Kit Roller/Centrifugal Pump (sprays approximately 30') .....	<b>9428149</b>	8 lbs.	\$289.00
21' Truss-T, rear cross-fold boom (13 nozzles) spray tips not included (3-section) .....	<b>DB21TDF</b>	85 lbs.	\$1,029.00
30' Truss-T, rear cross-fold boom (19 nozzles) spray tips not included (3-section) .....	<b>DB30TDF</b>	115 lbs.	\$1,288.00



#### Accessories

Hose Reel with 50' of 3/4" hose (uses existing handgun) .....	<b>9428114</b>	20 lbs.	\$229.00
Lawn & Turf Gun with #3 nozzle .....	<b>25660-3</b>	1 lbs.	\$124.00
LTL freight shipments require crating .....	<b>CRATE</b>		Net. \$58.00

# 80 Gallon PRO SERIES

Lawn & Garden

HAMILTON

## Features

- 80 gallon tank with a sloped bottom sump for total drainage, 5" fillwell, and 1 1/4" outlet.
- Gallon and liter markings on the tank.
- Agitation standard on all tanks.
- Special molded-in baffling in bottom of tanks for enhanced agitation.
- Pocket on top side of tank for extra chemical or fresh water jug.
- Rugged 12 gauge formed steel skid frame.
- 18 x 9.50 flotation tires on silver rims for trailer models.
- Electronic, diaphragm pump with Viton® valves will deliver 5 GPM. Draws 9 amps at 20 PSI.
- 3 HP Honda® engine with centrifugal pump will deliver 12 GPM @ 50 PSI - 65 PSI maximum pressure.
- 3.5 HP Briggs and Stratton engine with C4101GE pump delivering 6 GPM at 2600 RPM and 50 PSI. 150 PSI max.
- 4 HP Honda® with "Silver Cast" pump (XL4101).
- Hypro® 6 roller PTO pump (C6500D) will deliver 8 GPM at 540 RPM and 50 PSI. 150 PSI max.
- Handgun with 15' hose (380RB).
- 80" spray boom with 2 nozzles (AN1.5), 12' spray boom with 4 nozzles and spring loaded boom break away or 18' boom with 6 nozzles.
- Rear mount fits category "1" three-point.
- Skid dimensions 26.5" wide x 34" long x 39" high.

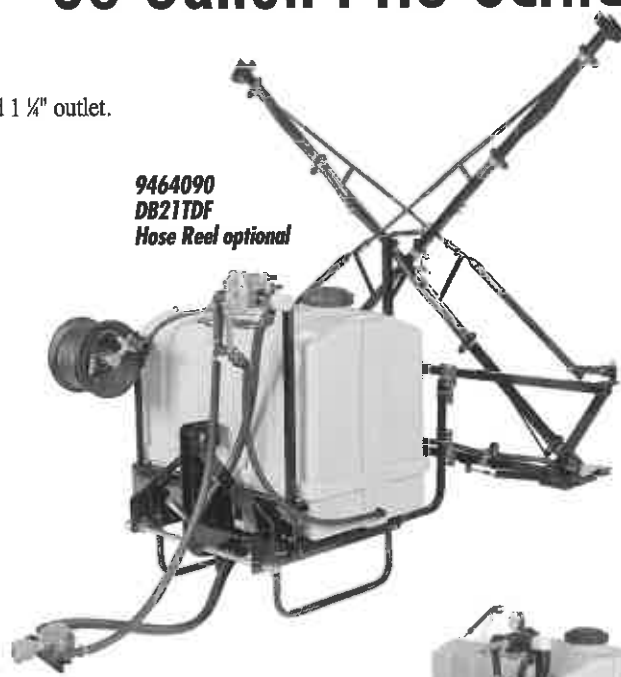

**2 Nozzle  
Boomless Kit**



**9464104  
DB12**



**9464088  
DB12**

NOTE: All sprayers are partially preassembled.

### HOW TO ORDER Choose in this order: 1. Model 2. Boom 3. Accessories



#### Model with Pump

80 Gallon Skid with electric 5 GPM pump. Skid base is 26 1/2" wide x 34" deep. ....	<b>9464065</b>	138 lbs.	\$1,285.00
80 Gallon Skid with 3.5 HP B&S engine and C4101GE pump Skid base is 26 1/2" wide x 34" deep. ....	<b>9464067</b>	181 lbs.	\$1,900.00
80 Gallon Skid with 4 HP Honda® and "Silver Cast" pump (XL4101) Skid base is 26 1/2" wide x 34" deep. ....	<b>9464069</b>	181 lbs.	\$2,545.00
80 Gallon Skid with Ace centrifugal pump and 3 HP Honda® engine (1-section). ....	<b>9464102</b>	181 lbs.	\$2,388.00
80 Gallon Skid with Ace centrifugal pump and 3 HP Honda® engine (3-section). ....	<b>9464097</b>	181 lbs.	\$2,597.00
80 Gallon Trailer with electric 5 GPM pump .....	<b>9464079</b>	202 lbs.	\$1,644.00
80 Gallon Trailer with 3.5 HP B&S engine and C4101GE pump .....	<b>9464081</b>	245 lbs.	\$2,245.00
80 Gallon Trailer with 4 HP Honda® and "Silver Cast" pump (XL4101) .....	<b>9464083</b>	245 lbs.	\$2,890.00
80 Gallon Trailer with Ace centrifugal pump and 3 HP Honda® engine (1-section). ....	<b>9464104</b>	181 lbs.	\$2,794.00
80 Gallon Trailer with Ace centrifugal pump and 3 HP Honda® engine (3-section). ....	<b>9464106</b>	181 lbs.	\$3,006.00
80 Gallon Rear Mount with electric 5 GPM pump .....	<b>9464086</b>	165 lbs.	\$1,367.00
80 Gallon Rear Mount with PTO 6 roller pump for 80", 12', or 18' boom (1-section) .....	<b>9464088</b>	184 lbs.	\$1,555.00
80 Gallon Rear Mount with PTO 6 roller pump for 21', 28', or 30' boom (3-section) .....	<b>9464090</b>	199 lbs.	\$1,796.00



#### Boom with Plumbing

80" Boom (2 nozzles)(40" spacing)(1-section) .....	<b>80B25</b>	10 lbs.	\$116.00
12' Boom (4 nozzles)(40" spacing)(1-section) .....	<b>DB12</b>	27 lbs.	\$252.00
18' Boom (6 nozzles)(40" spacing)(1-section) .....	<b>DB18</b>	38 lbs.	\$355.00
2 Nozzle Boomless Kit Electric Pump (sprays approximately 30') .....	<b>9428147</b>	8 lbs.	\$250.00
2 Nozzle Boomless Kit Roller/Centrifugal Pump (sprays approximately 30') .....	<b>9428149</b>	8 lbs.	\$289.00
21' Truss-T, rear cross-fold boom (13 nozzles) spray tips not included (3-section) .....	<b>DB21TDF</b>	85 lbs.	\$1,029.00
30' Truss-T, rear cross-fold boom (19 nozzles) spray tips not included (3-section) .....	<b>DB30TDF</b>	115 lbs.	\$1,288.00



#### Accessories

Hose Reel with 50' of 3/8" hose (uses existing handgun) .....	<b>9428114</b>	20 lbs.	\$229.00
Lawn & turf gun with #3 nozzle .....	<b>25660-3</b>	1 lbs.	\$124.00
LTL freight shipments require crating .....	<b>CRATE</b>		Net. \$58.00

# 110 & 150 Gallon PRO SERIES

## Features







- 110 or 150 gallon polyethylene tank features sump, molded sight gauge and large fillwell with a no-splash fillwell cover. 5 GPM electric and gas engine roller pump units include agitation in tank.
- Heavy duty formed steel skid frame (W-30" x L-70").
- Electric motor, diaphragm pump with Viton® valves. Draws 9 amps @ 20 PSI (delivers 5 GPM). Max. pressure is 35 PSI.
- 3 HP Honda® or 3.5 HP B&S with centrifugal pump with deliver of 12 GPM @ 50 PSI, 65 PSI maximum pressure. Fertilizer and Roundup® compatible.
- Hypro® engine driven roller pump (C4101) delivers a max. 6.6 GPM at 2600 RPM (open flow). Max. pressure is 150 PSI.
- Hypro® engine driven straight centrifugal pump: Pump delivers 94 GPM at 30 PSI. Max. pressure is 70 PSI.
- Ace engine driven centrifugal pump delivers 19 GPM max. and 40 PSI max. with 3.5 HP Briggs & Stratton engine.
- 18" handgun with 15' hose (380RB).
- 12' and 18' booms feature floodjet tips (AN1.5 with 40" nozzle spacing) and spring loaded boom wing breakaway.
- 21' Truss-T boom features vertical and horizontal boom breakaway with 20" nozzle spacing. Spray tips are not included. 10 GPA maximum output when used with electric pump.



Optional  
Lawn & Turf  
Handgun

NOTE: All sprayers are partially preassembled.

**HOW TO ORDER** Choose in this order: 1 Tank 2 Frame 3 Plumbing 4 Engine 5 Pump 6 Boom 7 Accessories

	<b>Tank</b>			
	110 Gallon Tank with agitation	P110 24A	40 lbs.	\$434.00
	150 Gallon Tank with agitation	P150 30A	50 lbs.	\$534.00
	<b>Frame</b>			
	110 Gallon Skid Frame	9464035	105 lbs.	\$584.00
	150 Gallon Skid Frame	9464036	110 lbs.	\$627.00
	<b>Plumbing</b>			
	5 GPM Electric pump plumbing kit (pump included)	9465008	10 lbs.	\$610.00
	4 Roller pump plumbing kit (1 Section) (engine/pump not included)	SMR	36 lbs.	\$526.00
	4 Roller pump plumbing kit (3 Section) (engine/pump not included)	SMR3	36 lbs.	\$647.00
	Centrifugal plumbing kit (1 Section) (engine/pump not included)	9465009	36 lbs.	\$517.00
	Centrifugal plumbing kit (3 Section) (engine/pump not included)	9465010	36 lbs.	\$747.00
	Centrifugal plumbing kit (1 Section) (3.5 HP B&S engine/pump included)	9465128	36 lbs.	\$1,199.00
	Centrifugal plumbing kit (1 Section) (3 HP Honda® engine/pump included)	9465129	36 lbs.	\$1,644.00
	<b>Engines</b>			
	3.5 HP B&S	GE3HP	28 lbs.	\$587.00
	4 HP Honda®	GH4HP	30 lbs.	\$1,156.00
	5.5 HP Honda® with centrifugal pump	DHC155H	65 lbs.	\$1,843.00
	6.5 HP with centrifugal pump	DHC155	53 lbs.	\$1,075.00
	<b>Pumps</b>			
	4 Roller pump	C4101	5 lbs.	\$174.00
	4 Roller "Silver Cast" pump	XL4101	5 lbs.	\$465.00
	<b>Boom with Plumbing</b>			
	12' Boom (4 Nozzles)(40" spacing)(1 Section)	DB12	27 lbs.	\$252.00
	18' Boom (6 Nozzles)(40" spacing)(1 Section)	DB18	38 lbs.	\$355.00
	21' Truss-T Boom (13 Nozzles) spray tips not included (3 Section)	DB21T	85 lbs.	\$762.00
	<b>Accessories</b>			
	Hose Reel with 100' of 1/2" Hose. Reel will hold 200'	9428035	90 lbs.	\$777.00
	1/2" Rubber Hose	120RB	per foot	\$1.53
	Lawn and Turf handgun	25660-3	1 lbs.	\$124.00
	LTL freight shipments require crating	CRATE		Net. \$58.00

# 150 & 200 Gallon PRO SERIES

## Features

- 150 or 200 gallon polyethylene elliptical tank features jet agitation, sump, molded sight gauge and fillwell with a no-splash fillwell cover.
- Trailer frame features height adjustment of up to 18" ground clearance, walking tandem axles with 22 x 11 x 8 pneumatic tires, or single axle with 24 x 12 turf tires, adjustable wheel spacing of (44" to 90" centers tandem)(72" to 90" singles).
- 2" ball coupler hitch.
- Walking tandems feature "lock out" for rigid axle spraying.
- 2 1/2 gallon clean water tank is mounted for added safety.
- PTO driven roller pump: Hypro® cast iron 6 roller pump (C6500D) delivers a maximum of 9.7 GPM at 540 RPM (open flow).
- Hypro® engine driven straight centrifugal pump: Pump delivers 94 GPM at 30 PSI. Maximum pressure is 70 PSI.
- Demco's 21', 30' and 40' Truss-T booms feature horizontal and vertical break-away hinges and 1/2" rubber hose with no-drip diaphragm check nozzles spaced at 20". 8' transport width.

Note: Sprayer is less spray tips. Factory set up is available.

**HOW TO ORDER** Choose in this order: 1. Tank/Trailer Frame Assembly with Tires 2. Pump and Plumbing 3. Controls 4. Boom 5. Accessories



### Tank/Trailer Frame Assembly

150 Gallon Tandem Axle Tank and Trailer Assembly .....	<b>9464055</b>	580 lbs.	\$4,260.00
200 Gallon Tandem Axle Tank and Trailer Assembly .....	<b>9464056</b>	610 lbs.	\$4,500.00
150 Gallon Single Axle Tank and Trailer Assembly .....	<b>9464058</b>	545 lbs.	\$3,915.00
200 Gallon Single Axle Tank and Trailer Assembly .....	<b>9464059</b>	575 lbs.	\$3,956.00



### Pumps and Plumbing Kit

NOTE: For Pump Specifications, see Components section

6.5 HP PowerPro™ Gas Engine with Centrifugal Pump and Plumbing Kit .....	<b>9970400</b>	75 lbs.	\$1,562.00
5.5 HP Honda® Gas Engine with Centrifugal Pump and Plumbing Kit .....	<b>9465029</b>	75 lbs.	\$2,320.00
PTO Mounted 6 Roller Pump and Plumbing Kit .....	<b>9970100</b>	35 lbs.	\$684.00
PTO Mounted 6 Roller "Silver Cast" Pump and Plumbing Kit .....	<b>9465025</b>	35 lbs.	\$1,022.00



### Controls

Manual Control Valves .....	<b>9465037</b>	5 lbs.	\$196.00
Electric Solenoid Control Valves .....	<b>9465038</b>	15 lbs.	\$1,220.00
Raven® 440 Sprayer Control with Ball Valves .....	<b>9428106</b>	15 lbs.	\$4,915.00



### Boom with Plumbing

NOTE: Order Spray Tips separately (see Components section)

21' Truss-T, rear cross-fold boom (13 nozzles) spray tips not included .....	<b>DB21TDF</b>	85 lbs.	\$1,029.00
30' Truss-T, rear cross-fold boom (19 nozzles) spray tips not included .....	<b>DB30TDF</b>	115 lbs.	\$1,288.00
40' Truss-T, rear cross-fold boom (25 nozzles) spray tips not included .....	<b>DB40TDF</b>	170 lbs.	\$1,723.00



### Accessories

Factory setup (Boom may be removed for shipping.) .....	<b>SU157</b>		Net \$4431.00
Hose Reel with 100' of 1/2" Hose. Reel will hold 200' (Handgun included) .....	<b>DHR</b>	95 lbs.	\$864.00
1/2" Rubber Hose .....	<b>120RB</b>	per foot	\$1.53
Handgun .....	<b>DBHGL</b>	13 lbs.	\$260.00
Fence Line Spray Kit, Manual .....	<b>9428003</b>	5 lbs.	\$88.00

# 300 Gallon Single Axle Sprayer







## Features

- 300 gallon polyethylene elliptical tank with two dual jet agitators and sump.
- 10 gauge formed steel trailer with 27" ground clearance and adjustable wheel spacings from 60"-80".
- A large convenient step, and work platform with safety rail.
- Three section manual or electric boom controls.
- Truss-T booms are complete with 1/2" plumbing and TeeJet® drip free diaphragm check nozzles spaced at 20".
- A clean water tank is conveniently mounted on each 300 gallon frame.

NOTE: Sprayer is less spray tips.  
Factory setup available.



**HOW TO ORDER** Choose in this order: 1. Tank 2. Trailer Frame 3. Tires 4. Pump 5. Plumbing 6. Controls 7. Boom 8. Accessories

	<b>Tank</b>			
	300 Gallon Tank .....	PE300RA	120 lbs.	\$1,170.00
	<b>Trailer Frame</b>			
	300 Gallon Single Axle Trailer with T11L Tires (60" - 80" wheel spacing) .....	HCMETR	780 lbs.	\$2,813.00
	<b>Pumps</b>			
	<i>NOTE: For Pump Specifications, see Component Section</i>			
	Hypro® 5 Roller Pump .....	C1700D	19 lbs.	\$517.00
	Hypro® "Silver Cast" 5 Roller Pump .....	XL1700D	19 lbs.	\$1,332.00
	Hypro® Belt Drive Pump with Constant Velocity PTO Shaft (C9402 540S) .....	9425071	66 lbs.	\$1,777.00
	Hypro® Hydraulic Pump (C9303HM1) (hose kit included) .....	9425056	36 lbs.	\$1,210.00
	<b>Plumbing / Pump Mount</b>			
	Roller Pump Kit (controls included) .....	9425002	44 lbs.	\$654.00
	Hypro® Belt Drive Kit .....	9425003	55 lbs.	\$652.00
	Hypro® Hydraulic Kit .....	9425004	49 lbs.	\$634.00
	<b>Controls</b>			
	Manual Control Valves for Centrifugal Pumps .....	CP3B3HV	22 lbs.	\$755.00
	Electric Solenoid Control Valves for Centrifugal Pumps .....	CP414HVR	26 lbs.	\$1,397.00
	<b>Boom with Plumbing</b>			
	<i>NOTE: Order Spray Tips separately see Component Section</i>			
	21' Truss-T boom .....	DB21TDF	85 lbs.	\$1,029.00
	30' Truss-T boom .....	DB30TDF	115 lbs.	\$1,288.00
	40' Truss-T boom .....	DB40TDF	170 lbs.	\$1,723.00
	Boomiess Jet Nozzle (Nozzle not included) .....	9464007	10 lbs.	\$93.00
	<b>Accessories</b>			
	Factory setup .....	SU341		Net \$627.00
	Quick Refill (utilizes nurse tank transfer pump for refilling) .....	CPTK1	15 lbs.	\$209.00
	Fence Line Spray Kit, Electric .....	9428002	5 lbs.	\$185.00
	Fence Line Spray Kit, Manual .....	9428003	5 lbs.	\$88.00
	Handgun (includes 25' of 1/2" hose) .....	DBHG	13 lbs.	\$260.00







# 300 Gallon Deluxe Single Axle Sprayer

## Features

- 300 gallon polyethylene elliptical tank with two dual jet agitators and sump.
- 10 gauge formed steel trailer with 27" ground clearance and adjustable wheel spacings from 60"-80"
- A large, convenient step and work platform with safety rail.
- A clean water tank is conveniently mounted on each 300 gallon frame.
- All truss booms are complete with 3/4" high volume plumbing and TeeJet® drip free diaphragm check nozzles with stainless steel boom and hose clamps spaced at 20".
- Demco's DBFT flotation boom mechanism is required on 300 gallon "Deluxe" sprayers.

NOTE: Sprayer is less spray tips. Factory setup available.

### HOW TO ORDER Choose in this order: 1. Tank 2. Trailer Frame 3. Tires 4. Pump 5. Plumbing 6. Controls 7. Boom 8. Accessories

	<b>Tank</b> 300 Gallon Tank .....	<b>PE300RA</b>	120 lbs.	\$1,170.00
	<b>Trailer Frame</b> 300 Gallon Single Axle Trailer with T11L Tires (60" - 80" wheel spacing) .....	<b>9411015</b>	1080 lbs.	\$3,366.00
	<b>Pumps</b> <i>NOTE: For Pump Specifications, see Component Section</i>			
	Hypro® 5 Roller Pump .....	<b>C1700D</b>	19 lbs.	\$517.00
	Hypro® "Silver Cast" 5 Roller Pump .....	<b>XL1700D</b>	19 lbs.	\$1,332.00
	Hypro® Gear Drive Pump with Constant Velocity PTO Shaft (C9016 540) .....	<b>9425015</b>	69 lbs.	\$1,642.00
	Hypro® Belt Drive Pump with Constant Velocity PTO Shaft (C9403 540S) .....	<b>9425026</b>	75 lbs.	\$1,831.00
	Hypro® Hydraulic Pump (C9303HM1)(hose kit included) .....	<b>9425056</b>	36 lbs.	\$1,210.00
	<b>Plumbing / Pump Mount</b>			
	Roller Pump Kit (Manual Controls included) .....	<b>9425002</b>	44 lbs.	\$654.00
	Hypro® Gear Drive Centrifugal Kit .....	<b>9425043</b>	60 lbs.	\$640.00
	Hypro® Belt Drive Centrifugal Kit .....	<b>9425003</b>	55 lbs.	\$652.00
	Hypro® Hydraulic Centrifugal Kit .....	<b>9425004</b>	49 lbs.	\$634.00
	<b>Controls</b>			
	Manual Control Valves for Centrifugal Pumps .....	<b>CP3B3HV</b>	22 lbs.	\$755.00
	Electric Solenoid Control Valves for Centrifugal Pumps .....	<b>CP414HVR</b>	26 lbs.	\$1,397.00
	<b>Boom with Plumbing</b> <i>NOTE: Order Spray Tips separately (see Component Section)</i>			
	Flotation Boom Mechanism (required on this model) .....	<b>DBFT</b>	112 lbs.	\$929.00
	28' Truss Boom with Drip Free Plumbing .....	<b>DB28DF</b>	255 lbs.	\$1,960.00
	30' Truss Boom with Drip Free Plumbing .....	<b>DB30DF</b>	272 lbs.	\$2,226.00
	45' Truss Boom with Drip Free Plumbing .....	<b>DB45DF</b>	305 lbs.	\$2,873.00
	<b>Accessories</b>			
	Factory setup .....	<b>SU341</b>		Net \$627.00
	Wheel Assisted Boom Tip Protectors .....	<b>DBTP</b>	27 lbs.	\$233.00
	Auto Boom Leveler .....	<b>DBSAL</b>	50 lbs.	\$648.00
	Quick Refill (utilizes nurse tank transfer pump for refilling) .....	<b>CPTK1</b>	15 lbs.	\$209.00
	Hydraulic Height Adjuster (24" travel) .....	<b>9428009</b>	190 lbs.	\$1,263.00
	Hydraulic Boom Wing Leveling .....	<b>DBHY</b>	26 lbs.	\$672.00
	Fence Line Spray Kit, Electric .....	<b>9428002</b>	5 lbs.	\$185.00
	Fence Line Spray Kit, Manual .....	<b>9428003</b>	5 lbs.	\$88.00
	Handgun (includes 25' of 1/2" hose) .....	<b>DBHG</b>	13 lbs.	\$260.00



# 500 Gallon Big Wheel Sprayer







## Features

- 500 gallon polyethylene elliptical tank with two dual jet agitators, sump, baffle and 16" flip-top manway.
- 10 gauge formed steel trailer with ground clearance of 29".
- Axle configuration allows 62" - 120" infinite wheel spacing.
- 11.2 x 38 bias 6 ply tires provide a large narrow footprint with less field compaction.
- Constant velocity PTO shaft or hydraulic driven centrifugal pump.
- The hydraulic X-fold boom features independent wing leveling and independent wing folding. The X-fold boom transports at 10' 8".
- All booms have stainless steel boom and hose clamps.
- Height adjustment - 2' of travel.



NOTE: Sprayer is less spray tips.  
Factory set up is standard

**HOW TO ORDER** Choose in this order: 1. Tank & Trailer Frame 2. Pump 3. Plumbing 4. Controls 5. Boom 6. Boom Accessories 7. Accessories

	<b>Tank and Trailer Frame with Tires</b> 500 Gallon Tank and Big Wheel Trailer (62" - 120" wheel spacing) (Red) .....	<b>9411027-10</b>	2229 lbs.	\$10,867.00
	<b>Pumps</b> <i>NOTE: For Pump Specifications, see Component Section.</i>			
	Hypro® 5 Roller Pump .....	<b>C1700D</b>	19 lbs.	\$517.00
	Hypro® Gear Drive Pump with Constant Velocity PTO Shaft (C9016 540) .....	<b>9425015</b>	69 lbs.	\$1,642.00
	Hypro® Belt Drive Pump with Constant Velocity PTO shaft (C9403 540S) .....	<b>9425026</b>	75 lbs.	\$1,831.00
	Hypro® Hydraulic Pump (C9303HM1) (hose kit included) .....	<b>9425056</b>	36 lbs.	\$1,210.00
	Ace Belt Drive Pump with Constant Velocity PTO shaft (PTOC800 10B150) .....	<b>9425055</b>	75 lbs.	\$1,798.00
	Ace Hydraulic Pump (FMC150HYD206) (hose kit included) .....	<b>9425057</b>	44 lbs.	\$1,188.00
	<b>Plumbing / Pump Mount</b>			
	Roller Pump Kit (Manual Controls included) .....	<b>9425002</b>	44 lbs.	\$654.00
	Hypro® Gear Drive Centrifugal Kit .....	<b>9425020</b>	60 lbs.	\$989.00
	Hypro®/Ace Belt Drive Centrifugal Kit .....	<b>9425010</b>	55 lbs.	\$928.00
	Hypro®/Ace Hydraulic Centrifugal Kit .....	<b>9425011</b>	49 lbs.	\$868.00
	<b>Controls</b>			
	Manual Controls for Centrifugal Pumps .....	<b>9428139</b>	10 lbs.	\$535.00
	Solenoid Valves for Centrifugal Pumps .....	<b>9428062</b>	30 lbs.	\$1,186.00
	Motorized Ball Valves for Centrifugal Pumps .....	<b>9428090</b>	35 lbs.	\$2,099.00
	Raven® 440 Sprayer Control w/Motorized Ball Valves for Centrifugal Pumps .....	<b>9428043</b>	45 lbs.	\$5,497.00
	<b>Hydraulic X-Fold Boom without Plumbing</b> (For Manual Fold Boom, see Page 11.)			
	45' Hydraulic X-Fold Boom with weight transfer kit .....	<b>9488125</b>	1550 lbs.	\$10,762.00
	60' Hydraulic X-Fold Boom with weight transfer kit .....	<b>9488127</b>	1620 lbs.	\$11,909.00
	<b>X-Fold Boom Accessories</b>			
	TeeJet® Drip Free (27 Nozzles) for 45' Hydraulic X-Fold Boom .....	<b>9428024</b>	20 lbs.	\$952.00
	TeeJet® Drip Free (37 Nozzles) for 60' Hydraulic X-Fold Boom .....	<b>9428026</b>	25 lbs.	\$1,143.00
	TeeJet® Triple Drip Free (27 Nozzles) for 45' Hydraulic X-Fold Boom .....	<b>9428046</b>	23 lbs.	\$1,276.00
	TeeJet® Triple Drip Free (37 Nozzles) for 60' Hydraulic X-Fold Boom .....	<b>9428008</b>	28 lbs.	\$1,645.00
	Wheel Assisted Boom Tip Protectors .....	<b>9488012</b>	27 lbs.	\$233.00
	Light Kit .....	<b>9428084</b>	10 lbs.	\$329.00
	<b>Accessories</b>			
	Quick Refill (utilizes nurse tank transfer pump for refilling) .....	<b>CPTK1</b>	15 lbs.	\$209.00
	55 Gallon Water Tank and Mountings for Flushing the Sprayer Tank .....	<b>DFS55HP</b>	95 lbs.	\$950.00
	33 Gallon Foam Marker (for more information, see Component Section) .....	<b>9428156</b>	107 lbs.	\$1,995.00
	Chemical Eductor Vacuum Flow (for more information, see Component Section) .....	<b>9428165</b>	125 lbs.	\$1,455.00
	Fence Line Spray Kit, Electric .....	<b>9428002</b>	5 lbs.	\$185.00
	Fence Line Spray Kit, Manual .....	<b>9428003</b>	5 lbs.	\$88.00
	Feeder Line Filter Kit (60 mesh) .....	<b>9428068</b>	3 lbs.	\$142.00
	Handgun (includes 25' of 1/2" hose) .....	<b>DBHG</b>	13 lbs.	\$260.00

Note: All factory setup units are tested to 90 PSI. Booms may be removed for shipping.

# 500 Gallon Tandem Axle Sprayer







## Features

- 500 gallon polyethylene elliptical tank with two dual jet agitators, sump, baffle and 16" fliptop manway.
- 10 gauge formed steel trailer with ground clearance of 29" and wheel spacings of 80"- 120" centers.
- 11L x 15 8 ply tires.
- Constant velocity PTO shaft with centrifugal pump, or hydraulic driven centrifugal pump.
- DFB boom offers manual rear folding, auto leveling and flotation suspension. 45' and 50' booms transport at 11'. 60' boom transports at 13' 10".
- All booms have stainless steel boom and hose clamps.

NOTE: Sprayer is less spray tips.  
Factory set up is standard



**HOW TO ORDER** Choose in this order: 1. Tank & Trailer Frame 2. Pump 3. Plumbing 4. Controls 5. Boom 6. Boom Accessories 7. Accessories

	<b>Tank and Trailer Frame with Tires</b> 500 Gallon Tank and Tandem Axle Trailer (80" - 120" wheel spacing) (Red) .....	<b>9411028-10</b>	2013 lbs.	\$9,710.00
	<b>Pumps</b> <i>NOTE: For Pump Specifications, see Component Section.</i>			
	Hypro® 5 Roller Pump .....	<b>C1700D</b>	19 lbs.	\$517.00
	Hypro® Gear Drive Pump with Constant Velocity PTO Shaft (C9016 540) .....	<b>9425015</b>	69 lbs.	\$1,642.00
	Hypro® Belt Drive Pump with Constant Velocity PTO shaft (C9403 540S) .....	<b>9425026</b>	75 lbs.	\$1,831.00
	Hypro® Hydraulic Pump (C9303HM1)(hose kit included) .....	<b>9425056</b>	36 lbs.	\$1,210.00
	Ace Belt Drive Pump with Constant Velocity PTO shaft (PTOC600 10B150) .....	<b>9425055</b>	75 lbs.	\$1,798.00
	Ace Hydraulic Pump (FMC150HYD206) (hose kit included) .....	<b>9425057</b>	44 lbs.	\$1,188.00
	<b>Plumbing / Pump Mount</b>			
	Roller Pump Kit (Manual Controls included) .....	<b>9425002</b>	44 lbs.	\$654.00
	Hypro® Gear Drive Centrifugal Kit .....	<b>9425020</b>	60 lbs.	\$989.00
	Hypro®/Ace Belt Drive Centrifugal Kit .....	<b>9425010</b>	55 lbs.	\$928.00
	Hypro®/Ace Hydraulic Centrifugal Kit .....	<b>9425011</b>	49 lbs.	\$868.00
	<b>Controls</b>			
	Manual Controls for Centrifugal Pumps .....	<b>9428139</b>	10 lbs.	\$535.00
	Solenoid Valves for Centrifugal Pumps .....	<b>9428062</b>	30 lbs.	\$1,186.00
	Motorized Ball Valves for Centrifugal Pumps .....	<b>9428090</b>	35 lbs.	\$2,099.00
	Raven® 440 Sprayer Control w/Motorized Ball Valves for Centrifugal Pumps .....	<b>9428043</b>	45 lbs.	\$5,497.00
	<b>Manual Fold Boom without Plumbing</b> <i>(For Hydraulic X-Fold Boom, see Page 10.)</i>			
	45' floating boom .....	<b>DFB45B</b>	608 lbs.	\$4,794.00
	60' floating boom .....	<b>DFB60B</b>	690 lbs.	\$5,775.00
	<b>Manual Fold Boom Accessories</b>			
	TeeJet® Drip Free (27 Nozzles) for 45' Manual Fold Boom .....	<b>9428051</b>	20 lbs.	\$867.00
	TeeJet® Drip Free (37 Nozzles) for 60' Manual Fold Boom .....	<b>9428053</b>	25 lbs.	\$1,143.00
	Wheel Assisted Boom Tip Protectors .....	<b>DFBTP</b>	27 lbs.	\$233.00
	Hydraulic Height Adjuster (24" travel) .....	<b>9428009</b>	190 lbs.	\$1,263.00
	Hydraulic Boom Leveling (for manual fold booms) .....	<b>DFHY</b>	28 lbs.	\$765.00
	<b>Accessories</b>			
	Quick Refill (utilizes nurse tank transfer pump for refilling) .....	<b>CPTK1</b>	15 lbs.	\$209.00
	55 Gallon Water Tank and Mountings for Flushing the Sprayer Tank .....	<b>DFS55HP</b>	95 lbs.	\$950.00
	33 Gallon Foam Marker (for more information, see Component Section) .....	<b>9428156</b>	107 lbs.	\$1,995.00
	Chemical Educator Vacuum Flow (for more information, see Component Section) .....	<b>9428165</b>	125 lbs.	\$1,455.00
	Fence Line Spray Kit, Electric .....	<b>9428002</b>	5 lbs.	\$185.00
	Fence Line Spray Kit, Manual .....	<b>9428003</b>	5 lbs.	\$88.00
	Feeder Line Filter Kit (60 mesh) .....	<b>9428068</b>	3 lbs.	\$142.00
	Handgun (includes 25' of 1/2" hose) .....	<b>DBHG</b>	13 lbs.	\$260.00

Note: All factory setup units are tested to 90 PSI. Booms may be removed for shipping.



# 850 Gallon Big Wheel

with 45', 60' or 66' boom



**Pendant boom control with five hydraulic front fold models**



## Features

- The 850 gallon polyethylene tank has a 16" flip-top lid and 2 high volume jet agitators. Its molded-in trough drains spills to rear of sprayer. The 100 gallon 2 stage sump provides optimum tank drainage and decreases sloshing.
- External liquid site gauge
- 120 gallon rear mounted rinse tank
- 2 1/2 gallon hand wash tank
- 1/2" steel-formed frame with 30" ground clearance, reducing crop damage.
- Fold-away ladder provides easy access to the large work platform, for added safety when filling tank.
- One of the shortest "hitch pin to axle" lengths in the industry - 140"
- 7000 lb. tongue jack
- Large storage compartment conveniently located for storing extra nozzles, clamps, etc.
- Single tube hitch frame allows for improved turning. The cast hitch can be adjusted vertically in 1 1/2" increments.
- 13.6 x 38 bias tires.
- Pump and plumbing are center mounted allowing for shorter hoses and improved pump priming.
- 50 mesh main filter and 60 mesh feeder line filters prevent tip plugging.
- Centrally located controls for convenient valve operation
- 160 lb. glycerin-filled gauge
- 2" quick couplers for bottom filling tanks
- The hydraulic front fold booms feature a nitrogen charged accumulator system combined with leveling linkage and shock absorbers to soften the ride. Live hydraulic control block requires only one set of remote outlets to perform all boom functions.
- The Hydraulic pendant/block can be used with open or closed center tractor hydraulic systems.
- Booms feature independent wing fold, hydraulic height adjust, wing leveling and outer wing breakaway.
- Boom folds to a transport width of 9' 6".
- Booms are available with 3/4" high volume plumbing and TeeJet® diaphragm check nozzles spaced at 20".
- All booms have stainless steel boom and hose clamps
- Light system consists of flasher/turn signal and taillights for added road safety.
- 7 gallon chemical eductor (optional)
- 33 gallon foam marker (optional)
- Approximate weight 6000 lbs



**Electric motorized ball valves**



**Chemical Eductor**

NOTE: Sprayer is less spray tips.  
Factory setup is standard.  
All sprayer plumbing is tested to 90 PSI.



**Trailer Assembly with Tank**

*Includes 38" wheels & tires*

850 Gallon Big Wheel Tank & Trailer Assembly (62"- 120" wheel spacing) (Red) .....	<b>9411134-10</b>		\$21,807.00
850 Gallon Big Wheel Tank & Trailer Assembly (62"- 120" wheel spacing) (Black) .....	<b>9411134-76</b>		\$21,807.00
850 Gallon Big Wheel Tank & Trailer Assembly (90"- 144" wheel spacing) (Red) .....	<b>9411135-10</b>		\$22,593.00
850 Gallon Big Wheel Tank & Trailer Assembly (90"- 144" wheel spacing) (Black) .....	<b>9411135-76</b>		\$22,593.00



**Pumps**

Hypro® Hydraulic Pump with Life Guard™ Seal & Flanged Ports (hoses included)(C9314HM1) .....	<b>9425073</b>	40 lbs.	\$1,630.00
Ace Hydraulic Pump with Silicone Carbide Seal & Flanged ports (FMC150HYD304) (hoses included) .....	<b>9425074</b>	38 lbs.	\$1,556.00



**Plumbing**

Motorized Ball Valves (console included) .....	<b>9425075</b>	35 lbs.	\$2,526.00
Raven® Flow Meter, Regulator, & Trailer Wire Harness w/3 Motorized Valves & Plumbing (7 valves maximum) .....	<b>9425078</b>		\$3,108.00



**Controls**

Raven® 440 Automatic Rate Control, Cable and Speed Sensor .....	<b>9425086</b>		\$2,735.00
Raven® Envizio Pro Automatic Rate Control, Auto Boom Shut Off, Light Bar, 10Hz Helix Antenna & Mapping .....	<b>9425089</b>		\$10,855.00



**Boom without Plumbing**

**Hydraulic Front Fold Boom**

45' Hydraulic Front Fold Boom .....	<b>9488132</b>		\$14,241.00
60' Hydraulic Front Fold Boom .....	<b>9488134</b>		\$14,892.00
66' Hydraulic Front Fold Boom .....	<b>9488135</b>		\$15,283.00

**Front Fold Boom Accessories**

TeeJet® Drip Free (27 Nozzles) for 45' Boom .....	<b>9428118</b>	20 lbs.	\$952.00
TeeJet® Triple Drip Free (27 Nozzles) for 45' Boom .....	<b>9428121</b>	23 lbs.	\$1,276.00
TeeJet® Drip Free (37 Nozzles) for 60' Boom .....	<b>9428108</b>	25 lbs.	\$1,143.00
TeeJet® Triple Drip Free (37 Nozzles) for 60' Boom .....	<b>9428109</b>	28 lbs.	\$1,663.00
TeeJet® Drip Free (40 Nozzles) for 66' Boom .....	<b>9428120</b>	25 lbs.	\$1,191.00
TeeJet® Triple Drip Free (40 Nozzles) for 66' Boom .....	<b>9428123</b>	30 lbs.	\$1,744.00
Wheel Assisted Boom Tip Protectors .....	<b>9488013</b>	27 lbs.	\$190.00



**Accessories**

Astro II GPS Speed Sensor 1Hz (for use with Raven® 440) .....	<b>14071</b>	1 lbs.	\$496.00
2" Flow Meter with digital display for tank fill .....	<b>9428163</b>	5 lbs.	\$1,310.00
33 Gallon Foam Marker Charcoal Tank (for more information, see Component Section) .....	<b>9428167</b>	107 lbs.	\$1,995.00
33 Gallon Foam Marker Yellow Tank (for more information, see Component Section) .....	<b>9428156</b>	107 lbs.	\$1,995.00
Chemical Eductor Vacuum Flow (for more information, see Component Section) .....	<b>9428164</b>	125 lbs.	\$1,809.00
Fence Line Spray Kit, Electric .....	<b>9428002</b>	5 lbs.	\$185.00
Fence Line Spray Kit, Manual .....	<b>9428003</b>	5 lbs.	\$88.00

**Note: All units are factory setup and tested to 90 PSI. 15" nozzle spacing available by special order.**



# 1050 Gallon Big Wheel

with 45', 60'  
or 66' boom



Pendant boom control with live hydraulic front fold models



## Features

- The 1050 gallon polyethylene tank has a 16" flip-top lid and 2 high volume jet agitators. It's molded-in trough drains spills to rear of sprayer. The 100 gallon 2 stage sump provides optimum tank drainage and decreases sloshing.
- External liquid site gauge
- 120 gallon rear mounted rinse tank
- 2 ½ gallon hand wash tank
- ¼" steel-formed frame with 30" ground clearance, reducing crop damage.
- Fold-away ladder provides easy access to the large work platform, for added safety when filling tank.
- One of the shortest "hitch pin to axle" lengths in the industry - 140"
- 7000 lb. tongue jack
- Large storage compartment conveniently located for storing extra nozzles, clamps, etc.
- Single tube hitch frame allows for improved turning. The cast hitch can be adjusted vertically in 1 ½" increments.
- 13.6 x 38 bias tire.
- Pump and plumbing are center mounted allowing for shorter hoses and improved pump priming.
- 50 mesh main filter and 80 mesh feeder line filters prevent tip plugging.
- Centrally located controls for convenient valve operation
- 160 lb. glycerin-filled gauge
- 2" quick couplers for bottom filling tanks
- The hydraulic front fold booms feature a nitrogen charged accumulator system combined with leveling linkage and shock absorbers to soften the ride. Live hydraulic control block requires only one set of remote outlets to perform all boom functions.
- The Hydraulic pendant/block can be used with open or closed center tractor hydraulic systems.
- Booms feature independent wing fold, hydraulic height adjust, wing leveling and outer wing breakaway.
- Boom folds to a transport width of 9' 6".
- Booms are available with ¾" high volume plumbing and TeeJet® diaphragm check nozzles spaced at 20".
- All booms have stainless steel boom and hose clamps
- Light system consists of flasher/turn signal and taillights for added road safety.
- 7 gallon chemical eductor (optional)
- 33 gallon foam marker (optional)
- Approximate weight 6100 lbs



Electric motorized ball valves



Chemical Eductor

NOTE: Sprayer is less spray tips.  
Factory setup is standard.  
All sprayer plumbing is tested to 90 PSI.



**Trailer Assembly with Tank**

*Includes 38" wheels & tires*

1050 Gallon Big Wheel Tank & Trailer Assembly (62"- 120" wheel spacing) (Red) .....	<b>9411139-10</b>		\$23,476.00
1050 Gallon Big Wheel Tank & Trailer Assembly (62"- 120" wheel spacing) (Black) .....	<b>9411139-76</b>		\$23,476.00
1050 Gallon Big Wheel Tank & Trailer Assembly (90"- 144" wheel spacing) (Red) .....	<b>9411140-10</b>		\$25,147.00
1050 Gallon Big Wheel Tank & Trailer Assembly (90"- 144" wheel spacing) (Black) .....	<b>9411140-76</b>		\$25,147.00



**Pumps**

Hypro® Hydraulic Pump with Life Guard™ Seal & Flanged Ports (hoses included)(C9314HM1) .	<b>9425073</b>	40 lbs.	\$1,630.00
Ace Hydraulic Pump with Silicone Carbide Seal & Flanged ports (FMC150HYD304) (hoses included) .....	<b>9425074</b>	38 lbs.	\$1,556.00



**Plumbing**

Motorized Ball Valves (console included) .....	<b>9425075</b>	35 lbs.	\$2,526.00
Raven® Flow Meter, Regulator, & Trailer Wire Harness w/3 Motorized Valves & Plumbing (7 valves maximum) .....	<b>9425078</b>		\$3,108.00



**Controls**

Raven® 440 Automatic Rate Control, Cable and Speed Sensor .....	<b>9425086</b>		\$2,735.00
Raven® Envizio Pro Automatic Rate Control, Auto Boom Shut Off, Light Bar, 10Hz Helix Antenna & Mapping .....	<b>9425089</b>		\$10,855.00



**Boom without Plumbing**

**Hydraulic Front Fold Boom**

45' Hydraulic Front Fold Boom .....	<b>9488132</b>		\$14,241.00
60' Hydraulic Front Fold Boom .....	<b>9488134</b>		\$14,892.00
66' Hydraulic Front Fold Boom .....	<b>9488135</b>		\$15,283.00

**Front Fold Boom Accessories**

TeeJet® Drip Free (27 Nozzles) for 45' Boom .....	<b>9428118</b>	20 lbs.	\$952.00
TeeJet® Triple Drip Free (27 Nozzles) for 45' Boom .....	<b>9428121</b>	23 lbs.	\$1,276.00
TeeJet® Drip Free (37 Nozzles) for 60' Boom .....	<b>9428108</b>	25 lbs.	\$1,143.00
TeeJet® Triple Drip Free (37 Nozzles) for 60' Boom .....	<b>9428109</b>	28 lbs.	\$1,663.00
TeeJet® Drip Free (40 Nozzles) for 66' Boom .....	<b>9428120</b>	25 lbs.	\$1,191.00
TeeJet® Triple Drip Free (40 Nozzles) for 66' Boom .....	<b>9428123</b>	30 lbs.	\$1,744.00
Wheel Assisted Boom Tip Protectors .....	<b>9488013</b>	27 lbs.	\$190.00



**Accessories**

Astro II GPS Speed Sensor 1Hz (for use with Raven® 440) ..	<b>14071</b>	1 lbs.	\$496.00
2' Flow Meter with digital display for tank fill .....	<b>9428163</b>	5 lbs.	\$1,310.00
33 Gallon Foam Marker Charcoal Tank (for more information, see Component Section) .....	<b>9428167</b>	107 lbs.	\$1,995.00
33 Gallon Foam Marker Yellow Tank (for more information, see Component Section) .....	<b>9428156</b>	107 lbs.	\$1,995.00
Chemical Eductor Vacuum Flow (for more information, see Component Section) .....	<b>9428164</b>	125 lbs.	\$1,809.00
Fence Line Spray Kit, Electric .....	<b>9428002</b>	5 lbs.	\$185.00
Fence Line Spray Kit, Manual .....	<b>9428003</b>	5 lbs.	\$88.00

**Note: All units are factory setup and tested to 90 PSI. 15" nozzle spacing available by special order.**



# 1050 Gallon Big Wheel

with 80/90' boom



**Pendant boom control with live hydraulic front fold models**



**Raven® 450 or Envizio Pro sprayer control system**



**Astro II GPS Speed Sensor for use with Raven® 450**

**Chemical Eductor**



**2" Flow Meter with digital display**

## Features

- The 1050 gallon polyethylene tank has a 16" flip-top lid and 2 high volume jet agitators. It's molded-in trough drains spills to rear of sprayer. The 100 gallon 2 stage sump provides optimum tank drainage and decreases sloshing.
- External liquid site gauge
- 120 gallon rear mounted rinse tank
- 2 ½ gallon hand wash tank
- ¼" steel-formed frame with 30" ground clearance, reducing crop damage.
- Fold-away ladder provides easy access to the large work platform for added safety when filling tank.
- One of the shortest "hitch pin to axle" lengths in the industry - 140"
- 7000 lb. tongue jack
- Large storage compartment conveniently located for storing extra nozzles, clamps, etc.
- Single tube hitch frame allows for improved turning. The cast hitch can be adjusted vertically in 1 ½" increments.
- 13.6 x 38 bias tires or 320 / 90R46 radial tires.
- Pump and plumbing are center mounted allowing for shorter hoses and improved pump priming.
- 50 mesh main filter and 80 mesh feeder line filters prevent tip plugging.
- Centrally located controls for convenient valve operation
- 160 lb. glycerin-filled gauge
- 2" quick couplers for bottom filling tanks
- The hydraulic front fold booms feature a nitrogen charged accumulator system combined with leveling linkage and shock absorbers to soften the ride. Live hydraulic control block requires only one set of remote outlets to perform all boom functions.
- The Hydraulic pendant/block for use with closed center tractor hydraulic system.
- Booms feature wing fold, hydraulic height adjust, independent wing leveling and outer wing breakaway.
- Boom can be folded to spray in a 60' or an unfolded 80 / 90' width.
- Boom folds to a transport width of 12'.
- Booms are available with ¾" high volume plumbing and TeeJet® diaphragm check nozzles spaced at 20".
- Wet boom plumbing offers a choice of either single or triple drip free diaphragm check nozzles.
- Light system consists of flasher/turn signal and taillights for added road safety.
- Unique hydraulic glide suspension system makes the boom wings weightless. The guide wheels activate the hydraulic system and automatically adjust for uneven terrain. Guide wheels have puncture proof tires. (optional).
- 7 gallon chemical eductor (optional)
- 33 gallon foam marker (optional)
- Approximate weight 6700 lbs

NOTE: Sprayer is less spray tips.  
Factory setup is standard.  
All sprayer plumbing is tested to 90 PSI.

### HYDRAULICS NOTES

Tractor must be equipped with closed center hydraulic system.



**Trailer Assembly with Tank**

Includes 38" wheels & tires

1050 Gallon Big Wheel Tank & Trailer Assembly (90"- 144" wheel spacing) (Red) .....	<b>9411140-10</b>		\$25,147.00
1050 Gallon Big Wheel Tank & Trailer Assembly (90"- 144" wheel spacing) (Black) .....	<b>9411140-76</b>		\$25,147.00

Includes 46" wheels & tires

1050 Gallon Big Wheel Tank & Trailer Assembly (90"- 144" wheel spacing) (Red) .....	<b>9411141-10</b>		\$28,916.00
1050 Gallon Big Wheel Tank & Trailer Assembly (90"- 144" wheel spacing) (Black) .....	<b>9411141-76</b>		\$28,916.00



**Pumps**

Hypro® Hydraulic Pump with Life Guard™ Seal & Flanged Ports (hoses included)(C9314HM1) ....	<b>9425073</b>	40 lbs.	\$1,630.00
Ace Hydraulic Pump with Silicone Carbide Seal & Flanged ports (FMC150HYD304) (hoses included) .....	<b>9425074</b>	38 lbs.	\$1,556.00



**Plumbing**

Raven® Flow Meter, Regulator, & Trailer Wire Harness w/5 Motorized Valves & Plumbing (7 valves maximum) .....	<b>9425081</b>		\$3,849.00
---	----------------	--	------------



**Controls**

Raven® 450 Automatic Rate Control, Cable and Speed Sensor .....	<b>9425087</b>		\$3,062.00
Raven® Envizio Pro Automatic Rate Control, Auto Boom Shut Off, Light Bar, 10Hz Helix Antenna & Mapping .....	<b>9425089</b>		\$10,855.00



**Boom without Plumbing**

**Hydraulic Front Fold Boom**

60', 80/90' Combination Hydraulic Front Fold Boom (Tractor must be equipped with closed center hydraulic system.) .....	<b>9488130</b>		\$24,094.00
---	----------------	--	-------------

*Note: For 80' spray pattern, outer 5' sections can be removed.*

**Front Fold Boom Accessories**

TeeJet® Drip Free (55 Nozzles) for 60', 80/90' Boom .....	<b>9428159</b>	20 lbs.	\$1,486.00
TeeJet® Triple Drip Free (55 Nozzles) for 60', 80/90' Boom .....	<b>9428160</b>	23 lbs.	\$2,278.00
Hydraulic Glide Suspension System (factory installed only) (Tractor must be equipped with closed center hydraulic system.) .....	<b>9428152</b>	20 lbs.	\$3,883.00



**Accessories**

Astro II GPS Speed Sensor 1Hz (for use with Raven® 450) .....	<b>14071</b>	1 lbs.	\$496.00
2" Flow Meter with digital display for tank fill .....	<b>9428163</b>	5 lbs.	\$1,310.00
33 Gallon Foam Marker Charcoal Tank (for more information, see Component Section) .....	<b>9428168</b>	107 lbs.	\$2,095.00
33 Gallon Foam Marker Yellow Tank (for more information, see Component Section) .....	<b>9428157</b>	107 lbs.	\$2,095.00
Chemical Educator Vacuum Flow (for more information, see Component Section) .....	<b>9428164</b>	125 lbs.	\$1,809.00
Fence Line Spray Kit, Electric .....	<b>9428002</b>	5 lbs.	\$185.00

**Note: All units are factory setup and tested to 90 PSI. 15" nozzle spacing available by special order.**

**HOW THE HYDRAULIC GLIDE SUSPENSION WORKS**



**Cab mounted console allows operator to adjust the precharge on the wing lift cylinders for optimal boom performance.**

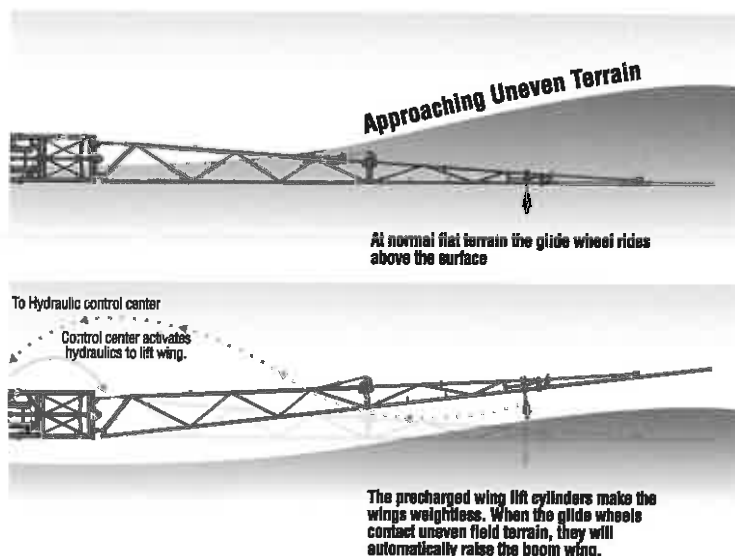



# 1250 Gallon Big Wheel

with  
80/90'  
boom

## HYDRAULICS NOTES

Tractor must be equipped with closed center hydraulic system.

## Features

- The 1250 gallon polyethylene tank has a 16" flip-top lid and 2 high volume jet agitators. It's molded-in trough drains spills to rear of sprayer. The 100 gallon 2 stage sump provides optimum tank drainage and decreases sloshing.
- External liquid site gauge
- 120 gallon rear mounted rinse tank
- 2 1/2 gallon hand wash tank
- 14" steel-formed frame with 30" ground clearance, reducing crop damage.
- Fold-away ladder provides easy access to the large work platform, for added safety when filling tank.
- One of the shortest "hitch pin to axle" lengths in the industry - 140"
- 7000 lb. tongue jack
- Large storage compartment conveniently located for storing extra nozzles, clamps, etc.
- Single tube hitch frame allows for improved turning. The cast hitch can be adjusted vertically in 1 1/2" increments.
- 320 / 90R46 radial tires provide a smooth ride and low field compaction.
- Pump and plumbing are center mounted allowing for shorter hoses and improved pump priming.
- 50 mesh main filter and 60 mesh feeder line filters prevent tip plugging.
- Centrally located controls for convenient valve operation
- 160 lb. glycerin-filled gauge
- 2" quick couplers for bottom filling tanks
- The hydraulic front fold booms feature a nitrogen charged accumulator system combined with leveling linkage and shock absorbers to soften the ride. Live hydraulic control block requires only one set of remote outlets to perform all boom functions.
- The Hydraulic pendant/block for use with closed center tractor hydraulic system.
- Booms feature wing fold, hydraulic height adjust, independent wing leveling and outer wing breakaway.
- Boom can be folded to spray in a 60' or an unfolded 80 / 90' width.
- Boom folds to a transport width of 12'.
- Booms are available with 3/4" high volume plumbing and TeeJet® diaphragm check nozzles spaced at 20".
- Boom plumbing offers a choice of either single or triple drip free diaphragm check nozzles.
- Light system consists of flasher/turn signal and taillights for added road safety.
- Unique hydraulic glide suspension system makes the boom wings weightless. The guide wheels activate the hydraulic system and automatically adjust for uneven terrain. Guide wheels have puncture proof tires. (optional).
- 7 gallon chemical eductor (optional)
- 33 gallon foam marker (optional)
- Approximate weight 7600 lbs

NOTE: Sprayer is less spray tips.  
Factory setup is standard.  
All sprayer plumbing is tested to 90 PSI.

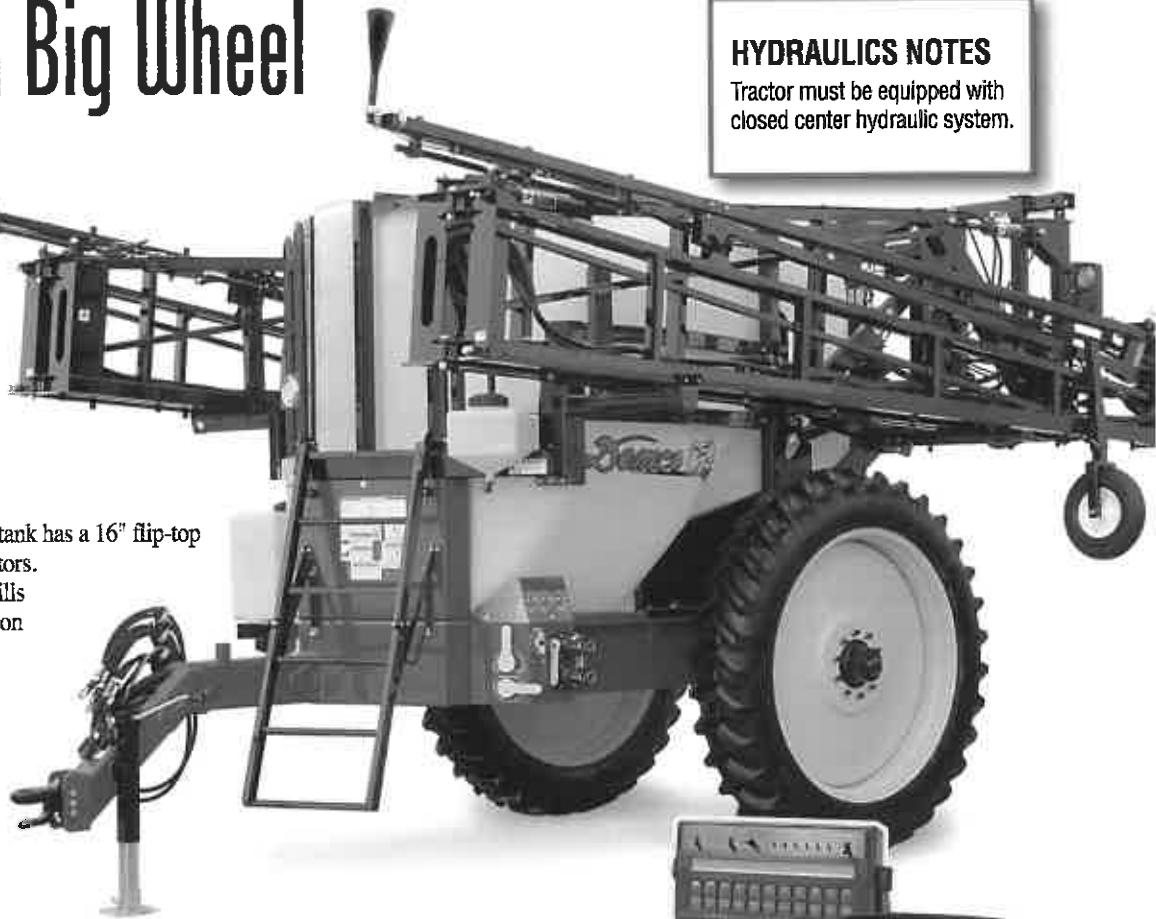

Raven® 450 or  
Envivio Pro sprayer  
control system



Astro II GPS Speed Sensor for  
use with Raven® 450



Chemical  
Eductor



2" Flow Meter with digital display



Pendant boom  
control with live  
hydraulic front  
fold models



**Trailer Assembly with Tank**

*Includes 46" wheels & tires*

1250 Gallon Big Wheel Tank & Trailer Assembly (90"- 144" wheel spacing) (Red) .....	<b>9411138-10</b>		\$30,115.00
1250 Gallon Big Wheel Tank & Trailer Assembly (90"- 144" wheel spacing) (Black) .....	<b>9411138-76</b>		\$30,115.00



**Pumps**

Hypro® Hydraulic Pump with Life Guard™ Seal & Flanged Ports (hoses included)(C9314HM1) .	<b>9425073</b>	40 lbs.	\$1,630.00
Ace Hydraulic Pump with Silicone Carbide Seal & Flanged ports (FMC150HYD304) (hoses included) .....	<b>9425074</b>	38 lbs.	\$1,556.00



**Plumbing**

Raven® Flow Meter, Regulator, & Trailer Wire Harness w/5 Motorized Valves & Plumbing (7 valves maximum) .....	<b>9425081</b>		\$3,849.00
---	----------------	--	------------



**Controls**

Raven® 450 Automatic Rate Control, Cable and Speed Sensor .....	<b>9425087</b>		\$3,062.00
Raven®Envizio Pro Automatic Rate Control, Auto Boom Shut Off, Light Bar, 10Hz Helix Antenna & Mapping	<b>9425089</b>		\$10,855.00



**Boom without Plumbing**

**Hydraulic Front Fold Boom**

60', 80/90' Combination Hydraulic Front Fold Boom (Tractor must be equipped with closed center hydraulic system.) .....	<b>9488130</b>		\$24,094.00
---	----------------	--	-------------

*Note: For 80' spray pattern, outer 5' sections can be removed.*

**Front Fold Boom Accessories**

TeeJet® Drip Free (55 Nozzles) for 60', 80/90' Boom .....	<b>9428159</b>		\$1,486.00
TeeJet® Triple Drip Free (55 Nozzles) for 60', 80/90' Boom .....	<b>9428160</b>		\$2,278.00
Hydraulic Glide Suspension System (factory installed only) (Tractor must be equipped with closed center hydraulic system.) .....	<b>9428152</b>	20 lbs.	\$3,883.00



**Accessories**

Astro II GPS Speed Sensor 1Hz (for use with Raven® 450) .....	<b>14071</b>	1 lbs.	\$496.00
2" Flow Meter with digital display for tank fill .....	<b>9428163</b>	5 lbs.	\$1,310.00
33 Gallon Foam Marker Charcoal Tank (for more information, see Component Section) .....	<b>9428168</b>	107 lbs.	\$2,095.00
33 Gallon Foam Marker Yellow Tank (for more information, see Component Section) .....	<b>9428157</b>	107 lbs.	\$2,095.00
Chemical Eductor Vacuum Flow (for more information, see Component Section) .....	<b>9428164</b>	125 lbs.	\$1,809.00
Fence Line Spray Kit, Electric .....	<b>9428002</b>	5 lbs.	\$185.00

**Note: All units are factory setup and tested to 90 PSI. 15" nozzle spacing available by special order.**

**HOW THE HYDRAULIC GLIDE SUSPENSION WORKS**



*Cab mounted console allows operator to adjust the precharge on the wing lift cylinders for optimal boom performance.*

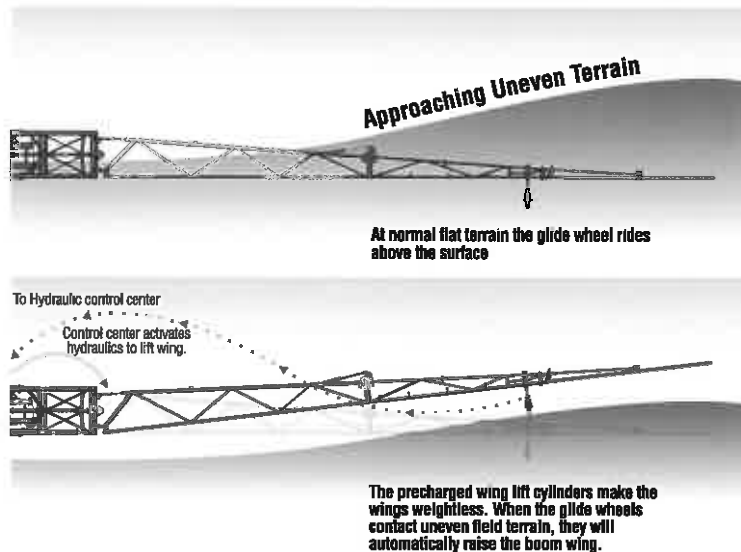



# 1200 Gallon SIDEQUEST® Sprayers

**Demco**  
SIDEQUEST



U.S. Patent No. 6,286,870

Shown with optional steps/platform

## FEATURES

- Two 600 gallon polyethylene tanks with 16" fillwells, molded sight gauge, large centered drainage sump and high volume jet agitator.
- Better visibility - Tanks are mounted longitudinal for superb visibility.
- Tank mounting brackets deliver excellent front to rear weight distribution ratio (25% front; 75% rear) and optimal row crop spraying clearance. Extended rear axle spindle mount allows weight to be shifted to the rear, relieving stress on the tractor's front axle and chassis. Units will fit on tractors with or without front duals. Rear duals are required.
- 3.5" rear spindle diameter with oil bathed tapered bearings located under tank, resulting in exceptional weight distribution
- Transport Width - 16' 11" when wheels/tracks are set on 120" centers.
- Tanks and brackets designed for optimal row crop spraying clearance
- 3 point 80/90° hydraulic front fold boom with leveling linkage and shock absorbers to soften the ride. Live hydraulic control block requires only one set of remote outlets to perform all boom functions.
- Boom can be folded to spray in a 60° or an unfolded 80/90° width.
- Unique hydraulic glide suspension system makes the boom wings weightless. The guide wheels activate the hydraulic system and automatically adjust for uneven terrain. Guide wheels have puncture proof tires. (optional).
- Quick & easy - 3-point rear mount hookup with quick couple plumbing and jack stands for easy installation and removal. Fits category II or III.
- Easy access control panel - makes easy work of preparation, refilling and clean-up.
- 100 gallon rinse tank - thoroughly flushes entire system.
- Front mounted step and work platform. (Optional)



Easy access controls.



Easy attach tank mounts.

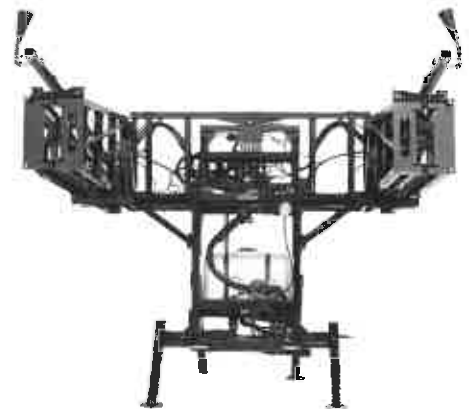

- NOTE: Tractors with aftermarket dual hubs may require different mounting bolts.
- NOTE: Hub spacer assembly is designed for tractors with 520 or narrower rear tractor tires.
- NOTE: Front fenders need to be removed on most models. Factory setup is standard for 3-point frame and boom assembly.
- NOTE: Not applicable on Tractors with mid frame hydraulics and front 3-point.





**Tanks & Brackets with 10 bolt hub assembly**

1200 Gallon, Charcoal Tanks, 30" row spacing	<b>9422209</b>	3550 lbs.	\$18,454.00
1200 Gallon, Yellow Tanks, 30" row spacing	<b>9422172</b>	3550 lbs.	\$18,454.00



**Tractor Mounting Brackets** (Brackets are required.)

Case IH® Magnum™ Tier 4A Emissions System 180, 190, 210, & 225	<b>9422197</b>	340 lbs.	\$2,496.00
Tractors with optional water/fuel separator - relocation kit	<b>6032</b>	5 lbs.	\$59.00
Case IH® MX Magnum™ 180, 200, 210, 220, 230, 240, 255, 270, & 285	<b>9422197</b>	340 lbs.	\$2,496.00
Case IH® MX 215, 245, 275 & 305	<b>9422197</b>	340 lbs.	\$2,496.00
Case IH® Magnum™ Tier 3 Emissions System 245, 275, 305 & *335	<b>9422197</b>	340 lbs.	\$2,496.00
<i>* Not applicable for 335 with front axle suspension</i>			
Case IH® Magnum™ Tier 4A Emissions System 235, 260, 290, 315 & *340	<b>9422183</b>	340 lbs.	\$2,496.00
Tractors with front suspension that have factory line interference will need a line kit from Case IH®			
*340 Tier 4A Emissions System hydraulic hose kit	<b>14063</b>	5 lbs.	\$115.06
Tractors with optional water/fuel separator - relocation kit	<b>6032</b>	5 lbs.	\$59.00
Challenger® MT645D, MT655D, MT665D, MT657D, & MT685D with stamped wheels	<b>9422218</b>		\$2,494.88
Massey Ferguson® 8650, 8660, 8670, 8680 & 8690 with stamped wheels	<b>9422218</b>		\$2,494.88
New Holland® TG210, TG215, TG230, TG245, TG255, TG275, TG285, TG305, T8010, T8020, T8030, T8040 & T8050	<b>9422191</b>	340 lbs.	\$2,496.00
New Holland® T8.275, T8.300, T8.330, T8.360 & T8.390	<b>9422193</b>	340 lbs.	\$2,496.00
Tractors with optional water/fuel separator - relocation kit	<b>6027</b>	5 lbs.	\$17.00
John Deere® 7200R, 7215R, 7230R, 7260R, & 7280R	<b>9422190</b>	340 lbs.	\$2,496.00
** John Deere® with powershift transmission 8100, 8200, 8300, 8400, 8110, 8210, 8310, 8410, 8120, 8220, 8320 with short frame & HD hubs	<b>9422176</b>	300 lbs.	\$1,782.00
** John Deere® with powershift transmission 8120, 8220, 8320, 8420, 8520, 8130, 8230, 8330, 8430, 8530, 8225R, 8235R, 8245R, 8260R, 8270R, 8285R, 8295R, 8310R, 8320R & 8335R with long frame & HD hubs	<b>9422177</b>	300 lbs.	\$2,496.00
** John Deere® with IVT™ transmission 8130, 8230, 8330, 8430, 8530, 8225R, 8235R, 8245R, 8260R, 8270R, 8285R, 8295R, 8310R, 8320R, 8335R, 8345R & 8360R with HD hubs	<b>9422178</b>	340 lbs.	\$2,496.00
** For tractors with standard hubs order kit	<b>6072</b>		\$183.00



**Three Point Frame**

Three Point Frame	<b>9488131</b>		\$4,274.00
-------------------	----------------	--	------------



**Pumps**

Ace Hydraulic Pump (FMC150HYD304) (hose kit included)	<b>9425068</b>	33 lbs.	\$1,492.00
Hypro Hydraulic Pump (C9314HM1) (hose kit included)	<b>9425067</b>	35 lbs.	\$1,608.00



**Plumbing / Pump Mount / Ball Valves**

Raven® Flow Meter, Regulator, & Trailer Wire Harness w/5 Motorized Valves & Plumbing (7 valves maximum)	<b>9425084</b>		\$6,070.00
---	----------------	--	------------



**Controls**

Raven® 450 Automatic Rate Control, Power Cable and Astro II GPS Speed Sensor 1Hz	<b>9425088</b>		\$2,735.00
Raven® Envizio Pro Automatic Rate Control, Auto Boom Shut Off, Light Bar, 10Hz Helix Antenna & Mapping	<b>9425089</b>		\$10,855.00



**Boom without Plumbing**

*NOTE: Warranty is void if mounted on track units.*

60', 80/90' Combination Hydraulic Front Fold Boom (Tractor must be equipped with closed center hydraulic system.)	<b>9488137</b>		\$24,094.00
---	----------------	--	-------------



**Boom Plumbing Packages**

*NOTE: Order Spray Tips Separately*

TeeJet® Drip Free (55 nozzles) for 60', 80/90' Hydraulic Front Fold Boom (5 section)	<b>9428159</b>		\$1,486.00
TeeJet® Triple Drip Free (55 nozzles) for 60', 80/90' Hydraulic Front Fold Boom (5 section)	<b>9428160</b>		\$2,278.00



**Accessories**

33 Gallon Charcoal Foam Marker	<b>9428168</b>	111 lbs.	\$2,095.00
33 Gallon Yellow Foam Marker	<b>9428157</b>	111 lbs.	\$2,095.00
Step / Platform	<b>9470024</b>		\$1,288.00
Hydraulic Glide Suspension System	<b>9428152</b>		\$3,883.00
Fence Line Spray Kit, Electric	<b>9428002</b>	5 lbs.	\$185.00
36" row spacing kit for Case IH Tier 4A	<b>6041</b>		\$550.00
36" row spacing kit	<b>6044</b>		\$597.00

**Note: All units are factory setup and tested to 90 PSI. 15" nozzle spacing available by special order.**



# Tractor Mount Quick fit List

## CASE IH

Model	Quick Tach 400	Quick Tach 500	Inline 400	Inline 600	SideQuest 700 & 1000	SideQuest 1200
MX Magnum 200	N/A	N/A	9422198	9422199	9422196	9422197
MX Magnum 210	N/A	N/A	9422198	9422199	9422196	9422197
MX Magnum 220	N/A	N/A	9422198	9422199	9422196	9422197
MX Magnum 230	N/A	N/A	9422198	9422199	9422196	9422197
MX Magnum 240	N/A	N/A	9422198	9422199	9422196	9422197
MX Magnum 255	N/A	N/A	9422198	9422199	9422196	9422197
MX Magnum 270	N/A	N/A	9422198	9422199	9422196	9422197
MX Magnum 285	N/A	N/A	9422198	9422199	9422196	9422197
MX 215	N/A	N/A	9422198	9422199	9422196	9422197
MX 245	N/A	N/A	9422198	9422199	9422196	9422197
MX 275	N/A	N/A	9422198	9422199	9422196	9422197
MX 305	N/A	N/A	9422198	9422199	9422196	9422197
Magnum 7110	TB470QTMFD	TB570QTMFD	9422063	9422064	9422159	N/A
Magnum 7120	TB470QTMFD	TB570QTMFD	9422063	9422064	9422159	N/A
Magnum 7130	TB470QTMFD	TB570QTMFD	9422063	9422064	9422159	N/A
Magnum 7140	TB470QTMFD	TB570QTMFD	9422063	9422064	9422159	N/A
Magnum 7150	TB470QTMFD	TB570QTMFD	9422063	9422064	9422159	N/A
Magnum 7210	TB470QTMFD	TB570QTMFD	9422063	9422064	9422159	N/A
Magnum 7220	TB470QTMFD	TB570QTMFD	9422063	9422064	9422159	N/A
Magnum 7230	TB470QTMFD	TB570QTMFD	9422063	9422064	9422159	N/A
Magnum 7240	TB470QTMFD	TB570QTMFD	9422063	9422064	9422159	N/A
Magnum 7250	TB470QTMFD	TB570QTMFD	9422063	9422064	9422159	N/A
Magnum 7250	TB470QTMFD	TB570QTMFD	9422063	9422064	9422159	N/A
Magnum 8910	TB470QTMFD	TB570QTMFD	9422063	9422064	9422159	N/A
Magnum 8920	TB470QTMFD	TB570QTMFD	9422063	9422064	9422159	N/A
Magnum 8930	TB470QTMFD	TB570QTMFD	9422063	9422064	9422159	N/A
Magnum 8940	TB470QTMFD	TB570QTMFD	9422063	9422064	9422159	N/A
Magnum 8950	TB470QTMFD	TB570QTMFD	9422063	9422064	9422159	N/A
Magnum 180	N/A	N/A	9422198	9422199	9422196	9422197
Magnum 190	N/A	N/A	9422198	9422199	9422196	9422197
Magnum 210	N/A	N/A	9422198	9422199	9422196	9422197
Magnum 215	N/A	N/A	9422198	9422199	9422196	9422197
Magnum 225	N/A	N/A	9422198	9422199	9422196	9422197
*Magnum 235	N/A	N/A	N/A	N/A	9422184	9422183
Magnum 245	N/A	N/A	9422198	9422199	9422196	9422197
**Magnum 260	N/A	N/A	N/A	N/A	9422184	9422183
Magnum 275	N/A	N/A	9422198	9422199	9422196	9422197
**Magnum 290	N/A	N/A	N/A	N/A	9422184	9422183
*Magnum 305	N/A	N/A	9422198	9422199	9422196	9422197
**Magnum 315	N/A	N/A	N/A	N/A	9422184	9422183
*Magnum 335	N/A	N/A	9422198	9422199	9422196	9422197
**Magnum 340	N/A	N/A	N/A	N/A	9422184	9422183
Magnum 370	N/A	N/A	N/A	N/A	N/A	N/A
Magnum 380	N/A	N/A	N/A	N/A	N/A	N/A
Stieger 335 (4WD)	N/A	N/A	N/A	9422206	N/A	9422205
Stieger 350 (4WD)	N/A	N/A	N/A	9422211	N/A	9422207
Stieger 400 (4WD)	N/A	N/A	N/A	9422211	N/A	9422207
Stieger 450 (4WD)	N/A	N/A	N/A	9422211	N/A	9422207

Magnums equipped with optional water/fuel separator require relocation kit (6032)

Some Tier 4 Emission Systems may require hydraulic hose kit (14063) on SideQuest models

\*305 & 335 equipped with optional suspended front end will only fit 700 & 1000 SideQuest

\*\*Tractors with front suspension that have factory line interference will need a line kit from Case IH®

# Tractor Mount Quick fit List

John Deere

MODEL	Quick Tach	Quick Tach	Inline	Inline	SideQuest	Short Frame	Long Frame
	400	500	400	600	700 & 1000	SideQuest	SideQuest
8100	9422168	9422169	9422067	9422068	9422164	9422176	N/A
8110	9422168	9422169	9422067	9422068	9422164	9422176	N/A
*8120	9422168	9422169	9422067	9422068	9422164	9422176	9422177
8130	9422168	9422169	9422067	9422068	9422164	N/A	9422177
8130 IVT	N/A	N/A	9422125	9422126	9422166	N/A	9422178
8200	9422168	9422169	9422067	9422068	9422164	9422176	N/A
8210	9422168	9422169	9422067	9422068	9422164	9422176	N/A
*8220	9422168	9422169	9422067	9422068	9422164	9422176	9422177
8225R	N/A	N/A	9422067	9422068	9422164	N/A	9422177
8225R IVT	N/A	N/A	9422125	9422126	9422166	N/A	9422178
8230	9422168	9422169	9422067	9422068	9422164	N/A	9422177
8230 IVT	N/A	N/A	9422125	9422126	9422166	N/A	9422178
8235R	N/A	N/A	9422067	9422068	9422164	N/A	9422177
8235R IVT	N/A	N/A	9422125	9422126	9422166	N/A	9422178
8245R	N/A	N/A	9422067	9422068	9422164	N/A	9422177
8245R IVT	N/A	N/A	9422125	9422126	9422166	N/A	9422178
8260R	N/A	N/A	9422067	9422068	9422164	N/A	9422177
8260R IVT	N/A	N/A	9422125	9422126	9422166	N/A	9422178
8270R	N/A	N/A	9422067	9422068	9422164	N/A	9422177
8270R IVT	N/A	N/A	9422125	9422126	9422166	N/A	9422178
8285R	N/A	N/A	9422067	9422068	9422164	N/A	9422177
8285R IVT	N/A	N/A	9422125	9422126	9422166	N/A	9422178
8295R	N/A	N/A	9422067	9422068	9422164	N/A	9422177
8295R IVT	N/A	N/A	9422125	9422126	9422166	N/A	9422178
8300	9422168	9422169	9422067	9422068	9422164	9422176	N/A
8310	9422168	9422169	9422067	9422068	9422164	9422176	N/A
8310R	N/A	N/A	9422067	9422068	9422164	N/A	9422177
8310R IVT	N/A	N/A	9422125	9422126	9422166	N/A	9422178
*8320	9422168	9422169	9422067	9422068	9422164	9422176	9422177
8320R	N/A	N/A	9422067	9422068	9422164	N/A	9422177
8320R IVT	N/A	N/A	9422125	9422126	9422166	N/A	9422178
8330	9422168	9422169	9422067	9422068	9422164	N/A	9422177
8330 IVT	N/A	N/A	9422125	9422126	9422166	N/A	9422178
8335R	N/A	N/A	9422067	9422068	9422164	N/A	9422177
8335R IVT	N/A	N/A	9422125	9422126	9422166	N/A	9422178
8345R IVT	N/A	N/A	9422125	9422126	9422166	N/A	9422178
8360R IVT	N/A	N/A	9422125	9422126	9422166	N/A	9422178
8400	9422168	9422169	9422067	9422068	9422164	9422176	N/A
8410	9422168	9422169	9422067	9422068	9422164	9422176	N/A
8420	9422168	9422169	9422067	9422068	9422164	N/A	9422177
8430	9422168	9422169	9422067	9422068	9422164	N/A	9422177
8430 IVT	N/A	N/A	9422125	9422126	9422166	N/A	9422178
8520	9422168	9422169	9422067	9422068	9422164	N/A	9422177
8530 IVT	N/A	N/A	9422125	9422126	9422166	N/A	9422178

\*8120, 8220 & 8320 models equipped with 46" rear tires will be short frame, models with 50" rear tires will be a long frame.

John Deere

MODEL	Quick Tach 400	Quick Tach 500
4050 4250 4350 4450 4750 4850	TB480QTMFD	TB560QTMFD
4055 4255 4455 4555 4755 4955	TB460QTMFD	TB560QTMFD
4560 4760 4960	TB460QTMFD	TB560QTMFD

Tractor Mounts Quick-Fit List

HAMILTON

# Tractor Mount Quick fit List

## John Deere

MODEL	Quick Tach	Quick Tach	Inline	Inline	SideQuest	SideQuest
	400	500	400	600	700 & 1000	1200
7200R	N/A	N/A	9422187	9422188	9422189	9422190
7215R	N/A	N/A	9422187	9422188	9422189	9422190
7230R	N/A	N/A	9422187	9422188	9422189	9422190
7260R	N/A	N/A	9422187	9422188	9422189	9422190
7280R	N/A	N/A	9422187	9422188	9422189	9422190
7400	N/A	N/A	N/A	N/A	N/A	N/A
7600	TB740QTMFD	TB750QTMFD	N/A	N/A	N/A	N/A
7610	TB740QTMFD	TB750QTMFD	N/A	N/A	N/A	N/A
7630	N/A	N/A	N/A	N/A	9422162	N/A
7700	TB740QTMFD	TB750QTMFD	N/A	N/A	N/A	N/A
7710	TB740QTMFD	TB750QTMFD	N/A	N/A	N/A	N/A
7720	N/A	N/A	N/A	N/A	9422162	N/A
7730	N/A	N/A	N/A	N/A	9422162	N/A
7800	TB740QTMFD	TB750QTMFD	N/A	N/A	N/A	N/A
7810	TB740QTMFD	TB750QTMFD	N/A	N/A	N/A	N/A
7820	N/A	N/A	N/A	N/A	9422162	N/A
7830	N/A	N/A	N/A	N/A	9422162	N/A
7920	N/A	N/A	N/A	N/A	9422162	N/A
7930	N/A	N/A	N/A	N/A	9422162	N/A

\*Not applicable on Tractors with mid frame hydraulics and front 3-point.

## John Deere Track

T Series	600	600	700/1000	700	1000
	Brackets	Tanks	Brackets	Tanks	Tanks
8100T	9422052	P300 31	9422116	9422112	9422114
8110T	9422052	P300 31	9422116	9422112	9422114
8120T	9422052	P300 31	9422116	9422112	9422114
8200T	9422052	P300 31	9422116	9422112	9422114
8210T	9422052	P300 31	9422116	9422112	9422114
8220T	9422052	P300 31	9422116	9422112	9422114
8230T	9422052	P300 31	9422116	9422112	9422114
8300T	9422052	P300 31	9422116	9422112	9422114
8310T	9422052	P300 31	9422116	9422112	9422114
8320T	9422052	P300 31	9422116	9422112	9422114
8330T	9422052	P300 31	9422116	9422112	9422114
8400T	9422052	P300 31	9422116	9422112	9422114
8410T	9422052	P300 31	9422116	9422112	9422114
8420T	9422052	P300 31	9422116	9422112	9422114
8430T	9422052	P300 31	9422116	9422112	9422114
8520T	9422052	P300 31	9422116	9422112	9422114
9300T	N/A	N/A	9422128	N/A	9422170
9320T	N/A	N/A	9422115	9422112	9422114
9400T	N/A	N/A	9422128	N/A	9422170
9420T	N/A	N/A	9422115	9422112	9422114
9430T	N/A	N/A	9422128	N/A	9422170
9520T	N/A	N/A	9422115	9422112	9422114
9530T	N/A	N/A	9422128	N/A	9422170
9620T	N/A	N/A	9422115	9422112	9422114
9630T	N/A	N/A	9422128	N/A	9422170
8295RT	N/A	N/A	9422167	N/A	9422170
8295RT	N/A	N/A	9422167	N/A	9422170
8310RT	N/A	N/A	9422167	N/A	9422170
8320RT	N/A	N/A	9422167	N/A	9422170
8335RT	N/A	N/A	9422167	N/A	9422170
8345RT	N/A	N/A	9422167	N/A	9422170
8360RT	N/A	N/A	9422167	N/A	9422170
9460RT	N/A	N/A	9422128	N/A	9422170
9510RT	N/A	N/A	9422128	N/A	9422170
9560RT	N/A	N/A	9422128	N/A	9422170

## John Deere 4WD

4WD	600	1200
	Brackets	Brackets
9230	9422210	9422204
9330	9422210	9422204
9430	9422210	9422204
9530	9422210	9422204
9630	9422210	9422204
9360R	9422210	9422204
9410R	9422210	9422204
9460R	9422210	9422204
9510R	9422210	9422204
9560R	9422210	9422204

\*Not applicable on Tractors with mid frame hydraulics and front 3-point.

# Tractor Mount Quick fit List

## New Holland

	Quick Tach 400	Quick Tach 500	In line 400	In line 600	SideQuest 700 & 1000	SideQuest 1200
TG 210	N/A	N/A	N/A	N/A	9422161	9422191
TG 215	N/A	N/A	N/A	N/A	9422161	9422191
TG 230	N/A	N/A	N/A	N/A	9422161	9422191
TG 245	N/A	N/A	N/A	N/A	9422161	9422191
TG 255	N/A	N/A	N/A	N/A	9422161	9422191
TG 275	N/A	N/A	N/A	N/A	9422161	9422191
TG 285	N/A	N/A	N/A	N/A	9422161	9422191
TG 305	N/A	N/A	N/A	N/A	9422161	9422191
T8.275	N/A	N/A	*9422185	*9422186	*9422192	*9422193
T8.300	N/A	N/A	*9422185	*9422186	*9422192	*9422193
T8.330	N/A	N/A	*9422185	*9422186	*9422192	*9422193
T8.360	N/A	N/A	*9422185	*9422186	*9422192	*9422193
T8.390	N/A	N/A	*9422185	*9422186	*9422192	*9422193
T8010	N/A	N/A	N/A	N/A	9422161	9422191
T8020	N/A	N/A	N/A	N/A	9422161	9422191
T8030	N/A	N/A	N/A	N/A	9422161	9422191
T8040	N/A	N/A	N/A	N/A	9422161	9422191
T8050	N/A	N/A	N/A	N/A	9422161	9422191
T9.390 4WD	N/A	N/A	N/A	9422211	N/A	9422207
T9.450 4WD	N/A	N/A	N/A	9422211	N/A	9422207
T9.505 4WD	N/A	N/A	N/A	9422211	N/A	9422207
T9.560 4WD	N/A	N/A	N/A	9422211	N/A	9422207

## Ford

	Quick Tach 400	Quick Tach 500	In line 400	In Line 600	SideQuest 700 & 1000	SideQuest 1200
8670	TB440QTMFD	TB540QTMFD	N/A	N/A	9422160	N/A
8770	TB440QTMFD	TB540QTMFD	N/A	N/A	9422160	N/A
8870	TB440QTMFD	TB540QTMFD	N/A	N/A	9422160	N/A
8970	TB440QTMFD	TB540QTMFD	N/A	N/A	9422160	N/A

## Buhler

	Quick Tach 400	Quick Tach 500	In line 400	In Line 600	SideQuest 700 & 1000	SideQuest 1200
2145	TB440QTMFD	TB540QTMFD	N/A	N/A	9422160	N/A
2160	TB440QTMFD	TB540QTMFD	N/A	N/A	9422160	N/A
2180	TB440QTMFD	TB540QTMFD	N/A	N/A	9422160	N/A
2210	TB440QTMFD	TB540QTMFD	N/A	N/A	9422160	N/A

## Challenger

	Quick Tach 400	Quick Tach 500	In line 400	In Line 600	SideQuest 700 & 1000	SideQuest 1200
MT645C/D	N/A	N/A	N/A	9422216	9422217	9422218
MT655C/D	N/A	N/A	N/A	9422216	9422217	9422218
MT665C/D	N/A	N/A	N/A	9422216	9422217	9422218
MT657C/D	N/A	N/A	N/A	9422216	9422217	9422218
MT685C/D	N/A	N/A	N/A	9422216	9422217	9422218

## Massey Ferguson

	Quick Tach 400	Quick Tach 500	In line 400	In Line 600	SideQuest 700 & 1000	SideQuest 1200
3630	TB430QTMFD	TB530QTMFD	N/A	N/A	N/A	N/A
3650	TB430QTMFD	TB530QTMFD	N/A	N/A	N/A	N/A
3670	TB430QTMFD	TB530QTMFD	N/A	N/A	N/A	N/A
3680	TB430QTMFD	TB530QTMFD	N/A	N/A	N/A	N/A
3690	TB430QTMFD	TB530QTMFD	N/A	N/A	N/A	N/A
8650	N/A	N/A	N/A	9422216	9422217	9422218
8660	N/A	N/A	N/A	9422216	9422217	9422218
8670	N/A	N/A	N/A	9422216	9422217	9422218
8680	N/A	N/A	N/A	9422216	9422217	9422218
8690	N/A	N/A	N/A	9422216	9422217	9422218

T8. tractors equipped with optional water fuel separator require relocation kit #6027

\*Not applicable for tractors equipped with front suspension



# 1200 Gallon SIDEQUEST®

## side mount units

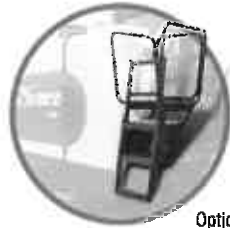

Optional Steps



U.S. Patent No. 6,286,870



### Features

- Two 600 gallon high capacity side mount tanks with 16" fillwell. Delivers excellent front to rear weight distribution ratio (25% front: 75% rear). Extended rear axle spindle mount allows weight to be shifted to the rear, relieving stress on the tractor's front axle and chassis. Units will fit on tractors with or without front duals. Rear duals are required.
- Better visibility - tanks are mounted longitudinal for superb visibility.
- Transport width - 30" Row Spacing (16' 11") when straddle duals are set on 120" centers.
- Transport width - 36" Row Spacing (18' 11") when straddle duals are set on 144" centers.
- Flanged fittings provide leak free plumbing.

NOTE: Tractors with aftermarket dual hubs may require different mounting bolts.

NOTE: Hub spacer assembly is designed for tractors with 520 or narrower rear tractor tires.

NOTE: Front fenders need to be removed on most models.

NOTE: Not applicable on Tractors with mid frame hydraulics and front 3-point.

### HOW TO ORDER Choose in this order. 1. Tanks & Brackets 2. Mounting Brackets 3. Accessories



#### Tanks & Brackets

1200 Gallon, Charcoal Tanks, 30" row spacing	<b>9422209</b>	3550 lbs.	\$18,454.00
1200 Gallon, Yellow Tanks, 30" row spacing	<b>9422172</b>	3550 lbs.	\$18,454.00



#### Tractor Mounting Brackets (Brackets are required.)

Case IH® Magnum™ Tier 4 Emissions System 180, 190, 210, & 225	<b>9422197</b>	340 lbs.	\$2,496.00
Tractors with optional water/fuel separator - relocation kit	<b>6032</b>	5 lbs.	\$59.00
Case IH® MX Magnum™ 180, 200, 210, 220, 230, 240, 255, 270, & 285	<b>9422197</b>	340 lbs.	\$2,496.00
Case IH® MX 215, 245, 275 & 305	<b>9422197</b>	340 lbs.	\$2,496.00
Case IH® Magnum™ Tier 3 Emissions System 245, 275, 305 & **335	<b>9422197</b>	340 lbs.	\$2,496.00
<i>** Not applicable for 335 with front axel suspension</i>			
Case IH® Magnum™ Tier 4 Emissions System 235, 260, 290, 315 & ***340	<b>9422183</b>	340 lbs.	\$2,496.00
***340 Tier 4 Emissions System hydraulic hose kit	<b>14063</b>	5 lbs.	\$115.06
Tractors with front suspension that have factory line interference will need a line kit from Case IH®			
Tractors with optional water/fuel separator - relocation kit	<b>6032</b>	5 lbs.	\$59.00
Challenger® MT645C/D, MT655C/D, MT665C/D, MT657C/D, & MT685C/D with stamped wheels	<b>9422218</b>		\$2,494.88
Massey Ferguson® 8650, 8660, 8670, 8680 & 8690 with stamped wheels	<b>9422218</b>		\$2,494.88
New Holland® TG210, TG215, TG230, TG245, TG255, TG275, TG285, TG305, T8010, T8020, T8030, T8040 & T8050	<b>9422191</b>	340 lbs.	\$2,496.00
New Holland® T8.275, T8.300, T8.330, T8.360 & T8.390	<b>9422193</b>	340 lbs.	\$2,496.00
Tractors with optional water/fuel separator - relocation kit	<b>6027</b>	5 lbs.	\$17.00
John Deere® 7200R, 7215R, 7230R, 7260R, & 7280R	<b>9422190</b>	340 lbs.	\$2,496.00
*John Deere® with powershift transmission 8100, 8200, 8300, 8400, 8110, 8210, 8310, 8410, 8120, 8220, 8320 with short frame & HD hubs	<b>9422176</b>	300 lbs.	\$1,782.00
*John Deere® with powershift transmission 8120, 8220, 8320, 8420, 8520, 8130, 8230, 8330, 8430, 8530, 8225R, 8235R, 8245R, 8260R, 8270R, 8285R, 8295R, 8310R, 8320R & 8335R with long frame & HD hubs	<b>9422177</b>	300 lbs.	\$2,496.00
*John Deere® with IVT™ transmission 8130, 8230, 8330, 8430, 8530, 8225R, 8235R, 8245R, 8260R, 8270R, 8285R, 8295R, 8310R, 8320R, 8335R, 8345R & 8360R with HD hubs	<b>9422178</b>	340 lbs.	\$2,496.00
*For tractors with standard Hubs order Kit	<b>6072</b>		\$183.00



#### Accessories

Step / Platform	<b>9470024</b>		\$1,288.00
Plumbing Kit for joining tanks includes 2" quick refill	<b>9470026</b>		\$468.00
36" row spacing kit for Case IH Tier 4	<b>6041</b>		\$550.00
36" row spacing kit	<b>6044</b>		\$597.00

# 700 & 1000 Gallon SIDEQUEST®

side mount units



Side mounts allow high or low clearance installation.



Shown with Optional X-fold Boom



U.S. Patent No. 6,286,870

## Features

- Two 350 or 500 gallon high capacity side mount tanks with 16" fillwell. Delivers excellent front to rear weight distribution ratio (25% front: 75% rear). Extended rear axle spindle mount allows weight to be shifted to the rear, relieving stress on the tractor's front axle and chassis. Units will fit on tractors with or without front duals. Rear duals are required.
- Better visibility - tanks are mounted longitudinal for superb visibility. Choose either high or low clearance for visibility and crop clearance.
- Roll-away jack stands - for easy installation and removal (optional).
- Comfortable transport width - 16' 4" when straddle duals are set on 120" centers.
- Flanged fittings provide leak free plumbing.

NOTE: Tractors with aftermarket dual hubs may require different mounting bolts.

NOTE: Hub spacer assembly is designed for tractors with 20.8 or narrower rear tractor tires.

NOTE: Front fenders need to be removed on most models.

NOTE: Not applicable on Tractors with mid frame hydraulics and front 3-point.



Optional outside step /platform

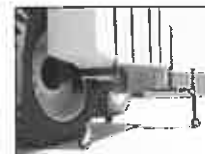

Optional roll-away jack stand

**HOW TO ORDER** Choose in this order: 1. Tanks & Brackets 2. Mounting Brackets 3. Accessories



### Tanks & Brackets with 10 bolt hub assembly

700 Gallon, Charcoal Tanks, 30" row spacing	9422214	1710 lbs.	\$11,948.00
700 Gallon, Yellow Tanks, 30" row spacing	9422151	1710 lbs.	\$11,948.00
1000 Gallon, Charcoal Tanks, 30" row spacing	9422212	2080 lbs.	\$14,002.00
1000 Gallon, Yellow Tanks, 30" row spacing	9422153	2080 lbs.	\$14,002.00
700 Gallon, Charcoal Tanks, 36" row spacing	9422215	1730 lbs.	\$12,358.00
700 Gallon, Yellow Tanks, 36" row spacing	9422155	1730 lbs.	\$12,358.00
1000 Gallon, Charcoal Tanks, 36" row spacing	9422213	2110 lbs.	\$14,411.00
1000 Gallon, Yellow Tanks, 36" row spacing	9422157	2110 lbs.	\$14,411.00



### Tractor Mounting Brackets (Brackets are required.)

Case IH® Magnum™ 7100, 7200 & 8900 series	9422159	223 lbs.	\$1,549.00
Case IH® Magnum™ Tier 4 Emissions System 180, 190, 210, & 225	9422196	340 lbs.	\$1,922.00
Tractors with optional water/fuel separator - relocation kit	6032	5 lbs.	\$59.00
Case IH® MX Magnum™ 180, 200, 210, 220, 230, 240, 255, 270, & 285	9422196	340 lbs.	\$1,922.00
Case IH® MX 215, 245, 275 & 305	9422196	340 lbs.	\$1,922.00
Case IH® Magnum™ Tier 3 Emissions System 245, 275, 305 & **335	9422196	340 lbs.	\$1,922.00
(* **335 with front axle suspension requires a spacer kit)	6019	15 lbs.	\$233.00
Case IH® Magnum™ Tier 4 Emissions System 235, 260, 290, 315 & ***340	9422184	340 lbs.	\$1,922.00
***340 Tier 4 Emissions System hydraulic hose kit	14063	5 lbs.	\$115.06
Tractors with front suspension that have factory line interference will need a line kit from Case IH®			
Tractors with optional water/fuel separator - relocation kit	6032	5 lbs.	\$59.00
Challenger® MT645C/D, MT655C/D, MT665C/D, MT657C/D, & MT685C/D with stamped wheels	9422217		\$1,922.00
Massey Ferguson® 8650, 8660, 8670, 8680 & 8690 with stamped wheels	9422217		\$1,922.00
New Holland® / Ford Genesis 8670, 8770, 8870, 8970, Buhler 2145, 2160, 2180 & 2210	9422160	200 lbs.	\$1,549.00
New Holland® TG210, TG215, TG230, TG245, TG255, TG275, TG285, TG305, T8010, T8020, T8030, T8040 & T8050	9422161	200 lbs.	\$1,549.00
New Holland® T8.275, T8.300, T8.330, T8.360 & T8.390	9422192	223 lbs.	\$1,922.00
Tractors with optional water/fuel separator - relocation kit	6027	5 lbs.	\$17.00
John Deere® 7720, 7820, 7920, 7730, 7830 & 7930	9422162	223 lbs.	\$1,549.00
John Deere® 7200R, 7215R, 7230R, 7260R, & 7280R (will not fit Trac with 3-point)	9422189	223 lbs.	\$1,922.00
*John Deere® 8100, 8200, 8300, 8400, 8110, 8210, 8310, 8410, 8120, 8220, 8320, 8420, 8130, 8230, 8330, 8430, 8225R, 8235R, 8245R, 8260R, 8270R, 8285R, 8295R, 8310R, 8320R & 8335R with powershift transmission & heavy duty hubs	9422164	180 lbs.	\$1,549.00
*John Deere® with IVT™ transmission 8130, 8230, 8330, 8430, 8530, 8225R, 8235R, 8245R, 8260R, 8270R, 8285R, 8295R, 8310R, 8320R, 8335R, 8345R & 8360R with HD hubs	9422166	230 lbs.	\$1,922.00
*For tractors with standard Hubs order Kit	6072		\$183.00



### Accessories

Roll-away Jack Stands	9470016	145 lbs.	\$794.00
Folding Step / Platform	9470023	50 lbs.	\$295.00
Plumbing Kit for joining tanks includes 2" quick refill	9470025		\$789.00

Tractor Mounts

HAMILTON



# 700 & 1000 Gallon SIDEQUEST® track units

## Features

- Two 350 or 500 gallon high capacity side mount tanks with 16" fillwell.
- Better visibility - tanks are mounted longitudinal for superb visibility.
- Comfortable transport width.



U.S. Patent No. 6,286,870

**HOW TO ORDER** Choose in this order: 1. Tanks 2. Square Tube Mounting Brackets



### Tanks

700 - 2/350 Gallon Yellow Tanks for John Deere® 8100T, 8200T, 8300T, 8400T, 8110T, 8210T, 8310T, 8410T, 8120T, 8220T, 8320T, 8420T, 8520T, 8420T, 8230T, 8330T, 8430T, 9300T, 9400T, 9320T, 9420T, 9520T & 9620T .....	<b>9422112</b>	1340 lbs.	\$7,462.00
1000 - 2/500 Gallon Yellow Tanks for John Deere® 8100T, 8200T, 8300T, 8400T, 8110T, 8210T, 8310T, 8410T, 8120T, 8220T, 8320T, 8420T, 8520T, 8420T, 8230T, 8330T, 8430T, 9300T, 9400T, 9320T, 9420T, 9520T & 9620T .....	<b>9422114</b>	1710 lbs.	\$9,279.00



### Tractor Mounting Brackets (required)

John Deere® 8100T, 8200T, 8300T, 8400T, 8110T, 8210T, 8310T, 8410T, 8120T, 8220T, 8320T, 8420T, 8520T, 8230T, 8330T & 8430T .....	<b>9422116</b>	600 lbs.	\$3,980.00
John Deere® 9300T, 9400T, 9320T, 9420T, 9520T & 9620T .....	<b>9422115</b>	540 lbs.	\$3,356.00



**HOW TO ORDER** Choose in this order: 1. Tanks 2. Round Tube Mounting Brackets



### Tanks

1000 - 2/500 Gallon Yellow Tanks .....	<b>9422170</b>	1410 lbs.	\$8,489.00
--	----------------	-----------	------------



### Tractor Mounting Brackets (required)

John Deere® 8310RT, 8335RT, 8295RT, 8320RT, 8345RT & 8360RT .....	<b>9422167</b>	598 lbs.	\$5,903.00
John Deere® 9320T, 9420T, 9520T, 9430T, 9530T, 9630T, 9460RT, 9510RT & 9560RT .....	<b>9422128</b>	590 lbs.	\$5,903.00

# 1200 Gallon SIDEQUEST®

## 4WD articulating tractor



U.S. Patent No. 6,286,870

### Features

- Two 600 gallon high capacity side mount tanks with 16" fillwell.
- Better visibility - tanks are mounted longitudinal for superb visibility.
- 21-23" of ground clearance.
- 17'-2" transport width

NOTE: Hub spacer assembly is designed for tractors with 520 or narrower tractor tires.

**HOW TO ORDER** Choose in this order: 1. Tanks 2. Square Tube Mounting Brackets



#### Tanks

1200 - 2/600 Gallon Yellow Tank .....	<b>9422200</b>	\$19,154.00
1200 - 2/600 Gallon Charcoal Tank .....	<b>9422208</b>	\$19,154.00



#### Tractor Mounting Brackets (required)

* John Deere® 9230, 9330, 9430, 9530, 9630, 9360R, 9410R, 9460R, 9510R & 9560R .....	<b>9422204</b>	\$3,081.00
Case IH® Steiger® 335 .....	<b>9422205</b>	\$3,081.00
Case IH® Steiger® 350, 400 & 450 .....	<b>9422207</b>	\$3,081.00
New Holland® T9.390, T9.450, T9.505 & T9.560 .....	<b>9422207</b>	\$3,081.00

\*Tractor must be equipped with front tractor reinforcement kit available from John Deere®

# 600 Gallon "Quick Tach"

## 4WD articulating tractor



### Features

- Two 300 gallon tanks. They feature dual jet agitation, sump, molded sight gauge and 12" fillwell with no-splash cover.
- High clearance brackets include saddles, tank bands, carrier brackets and all necessary bolts for a complete installation.
- 22-25" of ground clearance.
- 15' transport width

**HOW TO ORDER** Choose in this order: 1. Tanks 2. Square Tube Mounting Brackets



#### Tank (2 required)

300 Gallon Yellow Tank .....	<b>9422202</b>	\$927.00
300 Gallon Charcoal Tank .....	<b>9422203</b>	\$927.00



#### Tractor Mounting Brackets (required)

* John Deere® 9230, 9330, 9430, 9530, 9630, 9360R, 9410R, 9460R, 9510R & 9560R .....	<b>9422210</b>	\$5,555.00
Case IH® Steiger® 335 .....	<b>9422206</b>	\$5,555.00
Case IH® Steiger® Wheeled & Rowtrac™ 350, 400 & 450 .....	<b>9422211</b>	\$5,555.00
New Holland® T9.390, T9.450, T9.505 & T9.560 .....	<b>9422211</b>	\$5,555.00

\*Tractor must be equipped with front tractor reinforcement kit available from John Deere®

# "Quick Tach" Inline Tank Units

## mechanical front wheel drive tractors

### Features

- The Demco inline tanks are available in two sizes: 200 or 300 gallon capacities. They feature dual jet agitation, sump, molded sight gauge and fillwell with no-splash cover. The 300 gallon tank has a poly baffle.
- High clearance brackets allow for approximately 30" of ground clearance.
- Demco's centrifugal plumbing kits feature single section or three section electric controls.
- Transport width: 16' 6"

NOTE: Do not exceed the tractor manufacturer's frame load capacity recommendation.

NOTE: Not applicable on tractors with front duals.

NOTE: 60" front wheel spacing required.

NOTE: 60" diameter x 16" wide maximum front tire.

NOTE: Check tractor frame interference when equipped with front 3-point.

NOTE: Not applicable on Tractors with mid frame hydraulics and front 3-point.



#### HOW TO ORDER Choose in this order: 1. Tank 2. Tractor Mounting Brackets 3. Pump / Plumbing / Controls 4. Accessories



#### Tank (2 required)

200 gallon .....	<b>PC200A</b>	81 lbs.each	\$664.00
300 gallon .....	<b>PC300A</b>	130 lbs.each	\$1,398.00



#### Tractor Mounting Brackets

Case IH® 7110, 7120, 7130, 7140, 7150, 7210, 7220, 7230, 7240, 7250, 8910, 8920, 8930, 8940 & 8950 600 gallon .....	<b>9422064</b>	1195 lbs.	\$4,934.00
Case IH® MX Magnum™ 180, 200, 210, 220, 230, 240, 255, 270 & 285 (Tractors with suspended beam front axle require relocating accumulator) 400 gallon .....	<b>9422198</b>	1123 lbs.	\$4,608.00
600 gallon .....	<b>9422199</b>	1195 lbs.	\$4,934.00
Case IH® MX 215, 245, 275 & 305 (Tractors with suspended beam front axle require relocating accumulator) 400 gallon .....	<b>9422198</b>	1123 lbs.	\$4,608.00
600 gallon .....	<b>9422199</b>	1195 lbs.	\$4,934.00
Case IH® Magnum™ Tier 3 Emissions System 245, 275, 305 & 335* (Tractors with suspended beam front axle require relocating accumulator) *(Not applicable on 335 model with suspended beam front axle) 400 gallon .....	<b>9422198</b>	1123 lbs.	\$4,608.00
600 gallon .....	<b>9422199</b>	1195 lbs.	\$4,934.00
Case IH® Magnum™ Tier 4 Emissions System 180, 190, 210, 225 (Tractors with suspended beam front axle require relocating accumulator) Tractors with optional water/fuel separator - relocation kit .....	<b>6032</b>	5 lbs.	\$59.00
400 gallon .....	<b>9422198</b>	1123 lbs.	\$4,608.00
600 gallon .....	<b>9422199</b>	1195 lbs.	\$4,934.00
Challenger® MT645D, MT655D, MT665D, MT67D, & MT685D 400 gallon .....	<b>9422219</b>		\$4,607.30
600 gallon .....	<b>9422216</b>		\$4,934.00
Massey Ferguson® 8650, 8660, 8670, 8680 & 8690 400 gallon .....	<b>9422219</b>		\$4,607.30
600 gallon .....	<b>9422216</b>		\$4,934.00
New Holland® T8.275, T8.300, T8.330, T8.360 & T8.390 Tractors with optional water/fuel separator - relocation kit .....	<b>6027</b>	5 lbs.	\$17.00
400 gallon .....	<b>9422185</b>	1123 lbs.	\$4,608.00
600 gallon .....	<b>9422186</b>	1195 lbs.	\$4,934.00
John Deere® 7200R, 7215R, 7230R, 7260R & 7280R 400 gallon .....	<b>9422187</b>	1000 lbs.	\$4,608.00
600 gallon .....	<b>9422188</b>	1028 lbs.	\$4,934.00
John Deere® with power shift transmissions 8100, 8200, 8300, 8400, 8110, 8210, 8310, 8410, 8120, 8220, 8320, 8420, 8520, 8130, 8230, 8330, 8430, 8225R, 8235R, 8245R, 8260R, 8270R, 8285R, 8295R, 8310R, 8320R & 8335R 400 gallon .....	<b>9422067</b>	1000 lbs.	\$4,608.00
600 gallon .....	<b>9422068</b>	1028 lbs.	\$4,934.00
John Deere® with IVT® transmissions 8130, 8230, 8330, 8430, 8530, 8225R, 8235R, 8245R, 8260R, 8270R, 8285R, 8295R, 8310R, 8320R, 8335R, 8345R, & 8360R 400 gallon .....	<b>9422125</b>	1030 lbs.	\$5,212.00
600 gallon .....	<b>9422126</b>	1058 lbs.	\$5,537.00



#### Plumbing / Controls (Pump not included) NOTE: For Pump, see Components Section.

Plumbing kit (1 section electric) .....	<b>9470012</b>	40 lbs.	\$1,114.00
Plumbing kit (3 section electric) .....	<b>9470013</b>	65 lbs.	\$1,863.00
Quick refill (2" quick couplers) .....	<b>PTCTK1</b>	15 lbs.	\$196.00



#### Accessories

Roll-away Jack Stands .....	<b>9470015</b>	92 lbs.	\$469.00
Quick Refill (1 1/2" quick couplers) .....	<b>9470009</b>	15 lbs.	\$142.00
Quick Refill (2" quick couplers) .....	<b>PTCTK1</b>	15 lbs.	\$196.00

# "Quick Tach" Side Mount Tank Units

mechanical front wheel drive tractors





## Features

- Demco's slim-line polyethylene tanks come in two sizes: 200 or 250 gallon capacities. These tanks feature a dual jet agitator, sump, molded sight gauge and fillwell with a no-splash cover.
- Demco Quick Tach brackets come with saddles, tank bands, carrier brackets and all necessary bolts for complete installation. The undercarriage is bolted to the tractor and can remain on the tractor while the tanks can be removed quickly and easily.
- Transport width: 16'

NOTE: Not applicable on tractors with deep lug front tires or front duals. Fenders need to be removed on most models.  
NOTE: Do not exceed the tractor manufacturer's frame load capacity recommendation.



**HOW TO ORDER** Choose in this order: 1. Tank 2. Tractor Mounting Brackets 3. Pump 4. Plumbing / Controls 5. Accessories

	<b>Tank (2 required)</b>			
	200 gallon	PA200 24C	84 lbs. each	\$654.00
	250 gallon	PA250 24C	100 lbs. each	\$809.00
	<b>Tractor Mounting Brackets</b>			
	Case-IH® 7100, 7200 & 8900 Series			
	400 Gallon	TB470QTMFD	912 lbs.	\$3,612.00
	500 Gallon	TB570QTMFD	918 lbs.	\$3,650.00
	Ford Genesis 8670, 8770, 8870 & 8970 Buhler 2145, 2160, 2180 & 2210 (Not applicable with 18.4 or wider front tires)			
	400 Gallon	TB440QTMFD	927 lbs.	\$3,512.00
	500 Gallon	TB540QTMFD	933 lbs.	\$3,543.00
	John Deere® 4000 series			
	400 Gallon	TB460QTMFD	1075 lbs.	\$4,025.00
	500 Gallon	TB560QTMFD	1081 lbs.	\$4,056.00
	John Deere® 7600, 7700, 7800, 7610, 7710 & 7810 Adaptor Kit for Tractors with ILS™ front axles			
	400 Gallon	9470022	20 lbs.	\$126.00
	500 Gallon	TB740QTMFD	907 lbs.	\$3,612.00
		TB750QTMFD	913 lbs.	\$3,650.00
	John Deere® 8000 Series High Clearance Mounting Brackets (Not applicable for Tier 4 Emission system) (Not applicable with IVT® transmissions) (Not applicable with 20.8 or wider front tires)			
	400 Gallon	9422168	725 lbs.	\$3,512.00
	500 Gallon	9422169	731 lbs.	\$3,543.00
	Massey Ferguson® 3630, 3650, 3670, 3680 & 3690			
	400 Gallon	TB430QTMFD	912 lbs.	\$3,512.00
	500 Gallon	TB530QTMFD	918 lbs.	\$3,543.00
	<b>Pumps</b>			
	NOTE: For Pump Specifications, see Components Section.			
	Hypro® Gear Drive Pump 540 RPM	C9006 540	44 lbs.	\$1,062.00
	Hypro® Hydraulic Pump (C9303HM1)	C9303HM1	26 lbs.	\$998.00
	<b>Plumbing / Controls (Pump not included)</b>			
	Plumbing kit (1 section electric)	9470012	40 lbs.	\$1,114.00
	Plumbing kit (3 section electric)	9470013	65 lbs.	\$1,863.00
	<b>Accessories</b>			
	Quick refill (1½" quick couplers)	9470009	15 lbs.	\$142.00
	Quick refill (2" quick couplers)	PTCTK1	15 lbs.	\$196.00
	Quick Tach wheels and jackstand	QTWL	30 lbs.	\$336.00
	Quick Tach wheels and jackstand (for John Deere® 8000)	9470001	33 lbs.	\$397.00

# "Quick Tach" Side Mount

*tank units for standard two wheel drive tractors*

## Features

- Demco's slim-line polyethylene tanks come in two sizes: 200 or 250 gallon. Tanks feature a dual jet agitator, sump, molded sight gauge and fillwell with a no-splash cover.
- Demco "Quick Tach" brackets come with saddles, tank bands, carrier brackets and all necessary bolts for complete installation. The undercarriage is bolted to the tractor and can remain on the tractor while the tanks can be removed quickly and easily. The heavy duty brackets allow you to carry a total of 400 or 500 gallons.
- Transport width: 14'







NOTE: Do not exceed the tractor manufacturer's frame load capacity recommendation.

NOTE: Exhaust manifold should be shielded from tanks.

NOTE: Demco's side mount tractor brackets fit most flat side frames.

**HOW TO ORDER** Choose in this order: 1. Tank 2. Tractor Mounting Brackets 3. Pump 4. Plumbing / Controls 5. Accessories

	<b>Tank (2 required)</b> 200 gallon .....	<b>PA200 24C</b>	84 lbs.	each \$654.00
	250 gallon .....	<b>PA250 24C</b>	100 lbs.	each \$809.00
	<b>Tractor Mounting Brackets</b> Fit most flat side frames 400 gallon .....	<b>TB400QT</b>	650 lbs.	\$2,611.00
	500 gallon .....	<b>TB500QT</b>	650 lbs.	\$2,645.00
	<b>Pumps</b> NOTE: For Pump Specifications, see Components section Hypro® Gear Drive Pump 540 RPM .....	<b>C9006 540</b>	44 lbs.	\$1,062.00
	Hypro® Hydraulic Pump (C9303HM1) .....	<b>C9303HM1</b>	26 lbs.	\$998.00
	<b>Plumbing / Controls (Pump not included)</b> Plumbing kit (1 section electric) .....	<b>9470012</b>	40 lbs.	\$1,114.00
	Plumbing kit (3 section electric) .....	<b>9470013</b>	65 lbs.	\$1,863.00
	<b>Accessories</b> Quick refill (1 1/2" quick couplers) .....	<b>9470009</b>	15 lbs.	\$142.00
	Quick refill (2" quick couplers) .....	<b>PTCTK1</b>	15 lbs.	\$196.00
	Quick Tach wheels and jackstand .....	<b>QTWL</b>	30 lbs.	\$336.00



# Side Mount Tank Units

*for agricultural track drive tractors*

## Features

- Demco's slim-line polyethylene tanks come in two sizes: 250 or 300 gallon capacities. They feature a dual jet agitator, sump, molded sight gauge and fillwell with a no-splash cover.
- Demco brackets come with saddles, tank bands, carrier brackets and all necessary bolts for complete installation.
- Transport width: 16' 6"

NOTE: Do not exceed the tractor manufacturer's frame load capacity recommendation.

**HOW TO ORDER** Choose in this order: 1. Tank 2. Tractor Mounting Brackets

	<b>Tank</b> 300 Gallon (2 required) .....	<b>P300 31</b>	108 lbs.	each \$1,026.00
	<b>Tractor Mounting Brackets</b> John Deere 8000T 600 Gallon .....	<b>9422052</b>	1028 lbs.	\$3,318.00



# RM Series 600 Gallon rear mount units

## Features

- 600 gallon tank with 16 inch fillwell, jet agitation, molded sight gauge, and large centered drainage sump.
- Category "3" or "4" rear mount brackets may be used with "Quick Attach" three point hookup.
- Large, convenient platform with safety rail and ladder for easy filling of the tank.
- Retractable, built-in ground stand for storage when empty.
- A clean water tank is conveniently mounted on the rear mount unit.
- Available with 45, 60, 66 or 80/90' front fold booms.
- Approximate shipping weight 60 - 5110 lbs, 80/90' - 5710 lbs.

NOTE: Factory setup is standard.

NOTE: Order Spray Tips Separately.

**HOW TO ORDER** Choose in this order: 1 **Frame/Tank** 2 **Pump** 3 **Plumbing** 4 **Controls** 5 **Boom** 6 **Accessories**



### Frame

Frame with Charcoal 600 Gallon Tank ..... **9416023** \$6,888.00



### Pumps

Ace Hydraulic Pump (FMC150HYD304) (hose kit included) ..... **9425068** 33 lbs. \$1,492.00  
Hypro Hydraulic Pump (C9314HM1) (hose kit included) ..... **9425067** 35 lbs. \$1,608.00



### Plumbing / Pump Mount / Ball Valves

Raven® Flow Meter, Regulator, 3 Motorized Valves & Plumbing (use with 45, 60, 66' boom) ... **9425090** \$4,286.00  
Raven® Flow Meter, Regulator, 5 Motorized Valves & Plumbing (use with 80/90' boom)  
(7 valves maximum) ..... **9425091** \$5,009.00



### Controls

Raven® 440 Rate Controller (GPS Speed Sensor 1Hz included) (use with 45, 60, 66' boom) ... **9425092** \$2,952.00  
Raven® 450 Rate Controller (GPS Speed Sensor 1Hz included) (use with 80/90' boom) ..... **9425093** \$3,230.00  
Raven® Envizio Pro Automatic Rate Control, Auto Boom Shut Off, Light Bar, 10Hz Helix Antenna & Mapping  
(use with 80/90' boom) ..... **9425089** \$10,855.00



### Boom without Plumbing

#### Hydraulic Front Fold Boom

45' Hydraulic Front Fold Boom ..... **9488139** \$13,781.00  
60' Hydraulic Front Fold Boom ..... **9488140** \$14,337.00  
66' Hydraulic Front Fold Boom ..... **9488141** \$14,782.00  
60', 80/90' Combination Hydraulic Front Fold Boom  
(Tractor must be equipped with closed center hydraulic system.) ..... **9488142** \$24,688.00

NOTE: Warranty is void if mounted on track units.

#### Front Fold Boom Plumbing

TeeJet® Drip Free (27 Nozzles) for 45' Boom ..... **9428118** 20 lbs. \$952.00  
TeeJet® Triple Drip Free (27 Nozzles) for 45' Boom ..... **9428121** 23 lbs. \$1,276.00  
TeeJet® Drip Free (37 Nozzles) for 60' Boom ..... **9428108** 25 lbs. \$1,143.00  
TeeJet® Triple Drip Free (37 Nozzles) for 60' Boom ..... **9428109** 28 lbs. \$1,663.00  
TeeJet® Drip Free (40 Nozzles) for 66' Boom ..... **9428120** 25 lbs. \$1,191.00  
TeeJet® Triple Drip Free (40 Nozzles) for 66' Boom ..... **9428123** 30 lbs. \$1,744.00  
TeeJet® Drip Free (55 nozzles) for 60', 80/90' Hydraulic Front Fold Boom (5 section) ..... **9428159** \$1,486.00  
TeeJet® Triple Drip Free (55 nozzles) for 60', 80/90' Hydraulic Front Fold Boom (5 section) ..... **9428160** \$2,278.00



### 45, 60, 66' Boom Accessories

Foam Marker Mounting Kit ..... **9428170** 20 lbs. \$48.00  
33 Gallon Foam Marker with Charcoal Tank ..... **9428167** 107 lbs. \$1,995.00  
Wheel Assisted Boom Tip Protectors ..... **9488013** 27 lbs. \$190.00

### 80/90' Boom Accessories

Foam Marker Mounting Kit ..... **9428170** 20 lbs. \$48.00  
33 Gallon Foam Marker with Charcoal Tank ..... **9428168** 111 lbs. \$2,095.00  
Hydraulic Glide Suspension System ..... **9428152** \$3,883.00

### Accessories

2" Flow Meter with digital display for tank fill ..... **9428163** 5 lbs. \$1,310.00  
Fence Line Spray Kit, Electric ..... **9428002** 5 lbs. \$185.00  
Chemical Eductor Vacuum Flow (for more information, see Component Section) ..... **9428166** 125 lbs. \$1,455.00  
55 Gallon Tank and Mounting for Flushing the Sprayer Tank ..... **9428169** \$1,063.00



# RMLE Series 300, 400 & 500 Gallon

rear mount units

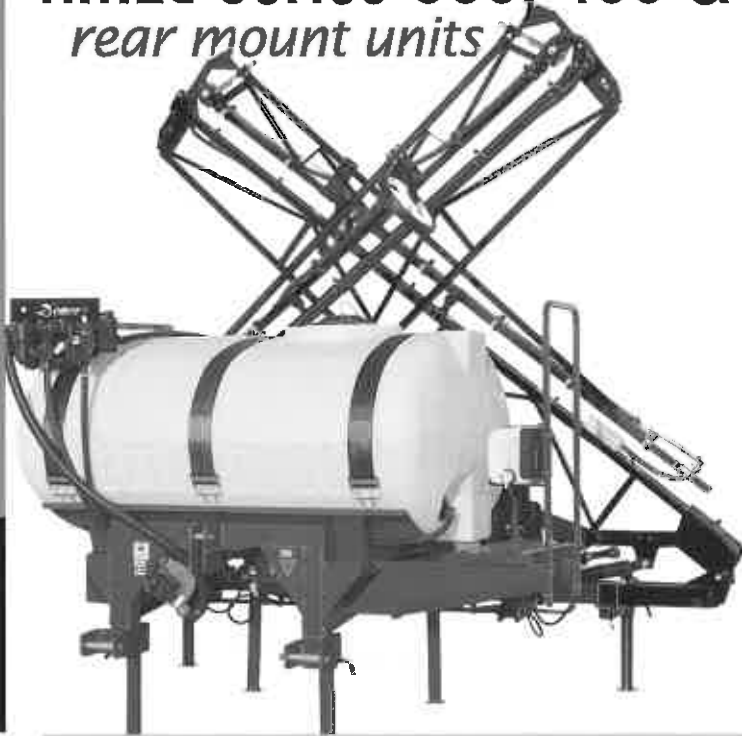

## Features

- 300, 400 or 500 gallon tank with jet agitation, molded sight gauge, sump and fillwell with no-splash cover.
- Rear mount brackets are complete with saddles, tank straps and all necessary bolts.
- Category "2" or "3" rear mount brackets may be used with "Quick Attach" three point hookup.
- Large, convenient platform with safety rail and ladder for easy filling of the tank.
- Retractable, built-in ground stand for storage when empty.
- A clean water tank is conveniently mounted on the rear mount unit.
- Available with three section electric controls for boom spraying.

NOTE: Rear mount is unassembled. Factory setup available.

NOTE: Raven® sprayer controllers require wheel sensor or radar cable (see Components section).

**HOW TO ORDER** Choose in this order: 1. **Frame** 2. **Tank** 3. **Pump** 4. **Plumbing** 5. **Controls** 6. **Boom** 7. **Accessories**



### Frame

300 Gallon Frame .....	<b>RMLE300P</b>	615 lbs.	\$2,441.00
400 Gallon Frame .....	<b>RMLE400P</b>	640 lbs.	\$2,524.00
500 Gallon Frame .....	<b>RMLE500P</b>	660 lbs.	\$2,598.00



### Tank

300 Gallon Tank .....	<b>PE300RA</b>	120 lbs.	\$1,170.00
400 Gallon Tank .....	<b>PE400RA</b>	135 lbs.	\$1,398.00
500 Gallon Tank .....	<b>PE500RA</b>	180 lbs.	\$1,741.00



### Pumps

NOTE: For Pump Specifications, see Components Section.

Hypro® Gear Drive Pump 540 RPM .....	<b>C9006 540</b>	44 lbs.	\$1,062.00
Hypro® hydraulic pump (C9303HM1) (hose kit included) .....	<b>9425056</b>	36 lbs.	\$1,210.00



### Plumbing

Plumbing Kit (3 section) .....	<b>9465059</b>	28 lbs.	\$399.00
--------------------------------	----------------	---------	----------



### Controls

3 section electric (solenoid valve) .....	<b>CP414HVR</b>	26 lbs.	\$1,397.00
3 section electric (ball valve) .....	<b>9428129</b>	35 lbs.	\$2,138.00
*3 section electric (ball valve) with Raven® 440 sprayer controller (wheel sensor not included) .....	<b>9428115</b>	45 lbs.	\$5,497.00
Astro II GPS Speed Sensor .....	<b>14071</b>	1 lbs.	\$496.00



### Boom

NOTE: Order Spray Tips separately (see Component section)

NOTE: Manual Fold Booms (see Boom section)

45' Hydraulic X-Fold Boom without plumbing .....	<b>9488064</b>	1160 lbs.	\$7,539.00
60' Hydraulic X-Fold Boom without plumbing .....	<b>9488070</b>	1275 lbs.	\$8,628.00
TeeJet® Drip Free Plumbing (27 nozzles) for 45' hydraulic X-fold boom .....	<b>9428024</b>	20 lbs.	\$952.00
TeeJet® Drip Free Plumbing (37 nozzles) for 60' hydraulic X-fold boom .....	<b>9428026</b>	25 lbs.	\$1,143.00



### Accessories

Wheel Assisted Boom Tip Protectors (for X-fold booms) .....	<b>9488012</b>	27 lbs.	\$233.00
Hydraulic Height Adjuster (24" travel) (for X-fold booms) .....	<b>9428133</b>	210 lbs.	\$1,699.00
Fence Line Spray Kit, Electric .....	<b>9428002</b>	5 lbs.	\$185.00
Fence Line Spray Kit, Manual .....	<b>9428003</b>	5 lbs.	\$88.00
Quick Refill (utilizes nurse tank transfer pump for refilling) .....	<b>CPTK1</b>	15 lbs.	\$209.00
Handgun (includes 25' of 1/2" hose) .....	<b>DBHG</b>	13 lbs.	\$260.00
Foam Marker Mounting Kit .....	<b>9428036</b>	25 lbs.	\$103.00
33 Gallon Foam Marker (requires mounting kit) .....	<b>9428156</b>	107 lbs.	\$1,995.00
Feeder Line Filter Kit (60 mesh) .....	<b>9428068</b>	3 lbs.	\$142.00
Factory setup (recommended) .....	<b>SURML</b>		Net \$719.00

\* For radar Y-adaptor cables or wheel sensors, see components section.



# RM Series 150 & 200 Gallon rear mount units

Tractor Mounts

HAMILTON



## Features

- 150 or 200 gallon tank with jet agitation, molded sight gauge, sump, fillwell with no-splash cover.
- Rear mount brackets are complete with saddles, tank bands and all necessary bolts.
- Rear mount brackets will fit categories "1" and "2".
- Unit may be used with a "Quick Attach" three point hookup.
- Non-retractable built-in ground stand for storage when empty.
- Hypro® 8 roller PTO pump (C7560D) will deliver 22 GPM at 1000 RPM, 12 GPM at 540 RPM and 300 PSI max.
- 21', 30' and 40' Truss-T booms feature vertical and horizontal boom breakaway, no drip diaphragm check nozzles spaced at 20".
- Handgun with 25' of hose (optional)









**BoomJet® nozzle**  
See Components section



Three section electric solenoid valve and control

One section electric

**HOW TO ORDER** Choose in this order: 1. **Frame** 2. **Tank** 3. **Boom** 4. **Pump and Plumbing** 5. **Controls** 6. **Accessories**

	<b>Frame</b>			
	Rear Mount Frame for 150 gallon tank .....	<b>9416006</b>	190 lbs.	\$1,214.00
	Rear Mount Frame for 200 gallon tank .....	<b>9416007</b>	200 lbs.	\$1,323.00
	<b>Tank</b>			
	150 Gallon Tank with agitation .....	<b>P150 32A</b>	50 lbs.	\$599.00
	200 Gallon Tank with agitation .....	<b>P200 32A</b>	64 lbs.	\$701.00
	<b>Boom with Plumbing</b> <i>Note: Order Spray Tips separately (see Components Section)</i>			
	21' Boom (3 section, 13 nozzles) .....	<b>DB21TDF</b>	85 lbs.	\$1,029.00
	30' Boom (3 section, 19 nozzles) .....	<b>DB30TDF</b>	115 lbs.	\$1,288.00
	40' Boom (3 section, 25 nozzles) .....	<b>DB40TDF</b>	170 lbs.	\$1,723.00
	BoomJet® Nozzle Bracket Kit (1 section, nozzle not included) .....	<b>9464050</b>	5 lbs.	\$93.00
	<b>Pumps and Plumbing Kit</b> (less controls)			
	<i>NOTE: For Pump Specifications (see Components Section)</i>			
	PTO Mounted 8 Roller Pump and Plumbing Kit (1 section) .....	<b>9465064</b>	28 lbs.	\$547.00
	PTO Mounted 8 Roller Pump and Plumbing Kit (3 section) .....	<b>9465066</b>	31 lbs.	\$608.00
	Centrifugal Pump Plumbing Kit (3 section) (Pump not included) .....	<b>9465068</b>	65 lbs.	\$418.00
	<b>Controls</b>			
	Manual (1 section) .....	<b>9465054</b>	2 lbs.	\$74.00
	Electric (1 section) .....	<b>9465055</b>	5 lbs.	\$234.00
	Manual (3 section) .....	<b>9465056</b>	5 lbs.	\$190.00
	Electric (3 section) .....	<b>9465057</b>	15 lbs.	\$886.00
	<b>Accessories</b>			
	Handgun (includes 25' of 1/2" hose) .....	<b>DBHGR</b>	13 lbs.	\$240.00
	Factory setup (Booms may be removed for shipping.) .....	<b>SURMU</b>		Net \$290.00
	LTL freight shipments require crating .....	<b>CRATE1</b>		Net \$67.00

# 80", 12' & 18' Booms

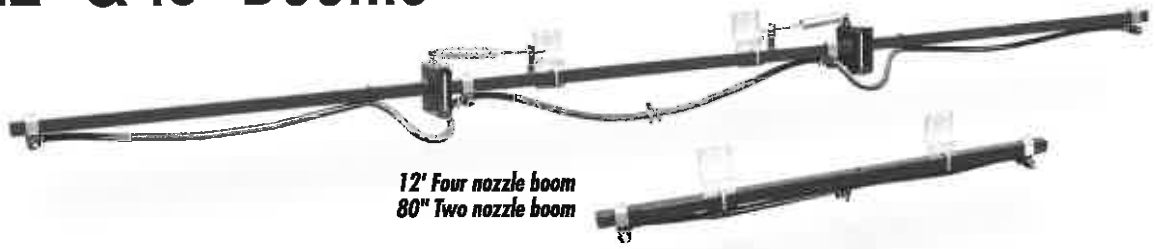

12' Four nozzle boom  
80" Two nozzle boom



**Boom without Plumbing**

12' Boom without Plumbing .....	<b>DB12B</b>	25 lbs.	\$193.00
18' Boom without Plumbing .....	<b>DB18B</b>	35 lbs.	\$276.00



**Boom with Plumbing 40" spacing**

80" Boom (2 nozzles) .....	<b>80B25</b>	10 lbs.	\$116.00
12' Boom (4 nozzles) .....	<b>DB12</b>	27 lbs.	\$252.00
18' Boom (6 nozzles) .....	<b>DB18</b>	38 lbs.	\$355.00

# 21', 30' & 40' Truss-T Booms



## Features

- Designed to meet the requirements of small acreage spraying.
- Vertical and horizontal breakaway minimizes needless wear and tear.
- All hose is 1/2" EPDM chemical resistant rubber.
- Demco's Truss-T booms are available on 150, 200 & 300 gallon trailer sprayers and 60, 80, 150 & 200 gallon rear mounts.

NOTE: 21' & 30' booms are partially preassembled.  
NOTE: 40' boom is shipped unassembled.  
NOTE: Feeder lines not included.



**Boom with Plumbing**

NOTE: Order Spray Tips separately (see Components section)

21' Truss-T boom (without plumbing) Transport width 8' .....	<b>DB21TB</b>	85 lbs.	\$637.00
30' Truss-T boom (without plumbing) Transport width 8' .....	<b>DB30TB</b>	115 lbs.	\$748.00
40' Truss-T boom (without plumbing) Transport width 10' .....	<b>DB40TB</b>	170 lbs.	\$1,129.00
21' Truss-T boom (13 conventional nozzles) Transport width 8' .....	<b>DB21T</b>	85 lbs.	\$762.00
30' Truss-T boom (19 conventional nozzles) Transport width 8' .....	<b>DB30T</b>	115 lbs.	\$906.00
40' Truss-T boom (25 conventional nozzles) Transport width 10' .....	<b>DB40T</b>	170 lbs.	\$1,343.00
21' Truss-T boom (13 TeeJet® drip free nozzles) Transport width 8' .....	<b>DB21TDF</b>	85 lbs.	\$1,029.00
30' Truss-T boom (19 TeeJet® drip free nozzles) Transport width 8' .....	<b>DB30TDF</b>	115 lbs.	\$1,288.00
40' Truss-T boom (25 TeeJet® drip free nozzles) Transport width 10' .....	<b>DB40TDF</b>	170 lbs.	\$1,723.00



**Accessories**

Convert a 21' Boom to a 30' Boom with Conventional Nozzles .....	<b>DB30TEX</b>	30 lbs.	\$151.00
Convert a 21' Boom to a 30' Boom with TeeJet® Drip Free Nozzles .....	<b>DB30TEXDF</b>	30 lbs.	\$280.00
Convert a 21' Boom to a 30' Boom without Plumbing .....	<b>DB30TEXB</b>	26 lbs.	\$114.00

# 28', 30', & 45' Truss Booms

## DTB series

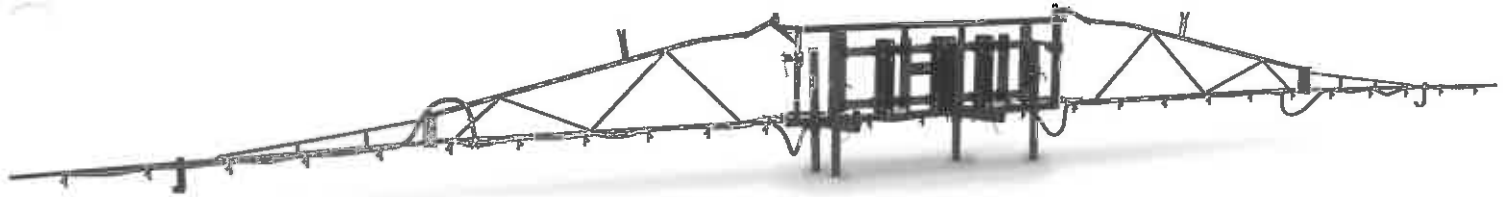

Booms

HAMILTON

### Features

- Heavy duty truss framework eliminates boom wing lashing.
- The boom is made of 1 1/4" heavy wall tubing and 1" tubing on the wing extensions.
- Vertical and horizontal breakaway on the boom wings.
- Boom neatly folds to the rear for 10' transport width.
- All booms are available with 3/4" high volume plumbing and TeeJet® drip free diaphragm check nozzles with stainless steel boom and hose clamps spaced at 20".
- Skids on both ends of boom to protect tips. Wheel assisted tip protectors are optional.
- Feeder lines not included.

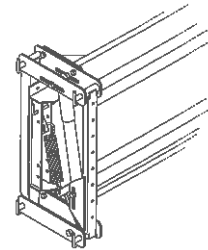

**Optional DBFT floating boom**

NOTE: Booms are unassembled. Factory setup is available.

NOTE: Demco flotation mechanism (DBFT) is recommended for truss boom.

### HOW TO ORDER 1. Select Boom 2. Review Optional Accessories



#### Boom

28' Truss Boom without Plumbing	<b>DB28B</b>	255 lbs.	\$1,467.00
30' Truss Boom without Plumbing	<b>DB30B</b>	272 lbs.	\$1,652.00
45' Truss Boom without Plumbing	<b>DB45B</b>	305 lbs.	\$2,153.00
28' Truss Boom with TeeJet® Drip Free Plumbing (17 nozzles)	<b>DB28DF</b>	280 lbs.	\$1,960.00
30' Truss Boom with TeeJet® Drip Free Plumbing (19 nozzles)	<b>DB30DF</b>	281 lbs.	\$2,226.00
45' Truss Boom with TeeJet® Drip Free Plumbing (27 nozzles)	<b>DB45DF</b>	322 lbs.	\$2,873.00



#### Accessories

Order Spray Tips separately (see Components section)

#### 3-POINT Mounting Kit

Mounting Brackets to attach Boom to a tractor's 3-point hitch (Category II & III)	<b>DTB3</b>	145 lbs.	\$701.00
---	-------------	----------	----------

#### REAR MOUNT Mounting Kit

Mounting Brackets to attach Boom to Demco 300 thru 500 gallon Rear Mount units	<b>9416012</b>	80 lbs.	\$333.00
--	----------------	---------	----------

#### TRAILER Mounting Kit

Universal Mounting Brackets to attach Boom to Trailer Frame	<b>DB9</b>	85 lbs.	\$397.00
---	------------	---------	----------

Factory setup	<b>SUDB</b>		Net \$240.00
---------------	-------------	--	--------------

Flotation Mechanism	<b>DBFT</b>	112 lbs.	\$929.00
---------------------	-------------	----------	----------

Auto Boom Leveler	<b>DBSAL</b>	50 lbs.	\$648.00
-------------------	--------------	---------	----------

Hydraulic Height Adjuster for trailer and rear mount models (24" travel)	<b>9428009</b>	190 lbs.	\$1,263.00
--	----------------	----------	------------

Hydraulic Boom Wing Leveling	<b>DBHY</b>	26 lbs.	\$672.00
------------------------------	-------------	---------	----------

Wheel Assisted Boom Tip Protectors	<b>DBTP</b>	27 lbs.	\$233.00
------------------------------------	-------------	---------	----------

Fence Line Spray Kit, Electric	<b>9428002</b>	5 lbs.	\$185.00
--------------------------------	----------------	--------	----------

Fence Line Spray Kit, Manual	<b>9428003</b>	5 lbs.	\$88.00
------------------------------	----------------	--------	---------

Convert a 28' Boom to a 30' Boom without Plumbing	<b>DB30EXB</b>	14 lbs.	\$187.00
---	----------------	---------	----------

Convert a 28' Boom to a 45' Boom without Plumbing	<b>DB45EXB</b>	37 lbs.	\$684.00
---	----------------	---------	----------

Convert a 28' Boom to a 30' Boom with TeeJet® Plumbing	<b>DB30EXDF</b>	17 lbs.	\$264.00
--	-----------------	---------	----------

Convert a 28' Boom to a 45' Boom with TeeJet® Plumbing	<b>DB45EXDF</b>	52 lbs.	\$911.00
--	-----------------	---------	----------

# 45' & 60' Manual fold

*floating booms*



## Features

- Compact Boom: Overall sprayer length (from sprayer frame of boom) is very close and compact for better weight distribution of the entire sprayer.
- Boom is standard with auto-level and shock & spring flotation system.
- Reinforced hinges for spraying at faster speeds and through rougher field conditions.
- Heavy duty boom latches at folding joints.
- Boom wings and wing extensions are constructed of 1 1/4" heavy wall tubing.
- Spring loaded breakaway. Simple maintenance. Easy to reach grease zerks. Fewer moving parts.
- Rear fold boom, all horizontal folding hinges. Less chance of chemical exposure than booms that fold vertically.
- All booms are available with 3/4" high volume plumbing and TeeJet® drip free diaphragm check nozzles with stainless steel boom and hose clamps spaced at 20".
- Transport width 45' booms: 11'
- Transport width 60' boom: 13' 10"

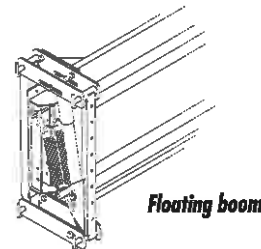

*Floting boom*

### HOW TO ORDER 1. Choose Boom 2. Choose Boom Plumbing 3. Choose Accessories



#### Boom without Plumbing

*NOTE: If a 60' boom is ordered, Demco recommends the 80"-120" wheel spacing trailer.*

45' Floating Boom .....	<b>DFB45B</b>	608 lbs.	\$4,794.00
60' Floating Boom .....	<b>DFB60B</b>	690 lbs.	\$5,775.00



#### Boom Plumbing

*NOTE: Order Spray Tips separately (see Components section)*

TeeJet® Drip Free (27 Nozzles) for 45' floating boom .....	<b>9428051</b>	20 lbs.	\$867.00
TeeJet® Drip Free (37 Nozzles) for 60' floating Boom .....	<b>9428053</b>	25 lbs.	\$1,143.00



#### Accessories

##### 3-POINT Mounting Kit

Mounting Brackets to attach Boom to a tractor's 3-point hitch (Category II & III) .....	<b>DTB3</b>	145 lbs.	\$701.00
---	-------------	----------	----------

##### REAR MOUNT Mounting Kit

Mounting Brackets and Safety Stands to attach Boom to Demco 300 thru 500 gallon Rear Mount Units .....	<b>9416004</b>	80 lbs.	\$383.00
--	----------------	---------	----------

##### TRAILER Mounting Kit

Universal Mounting Brackets to attach Boom to Trailer Frame Units .....	<b>DHB9</b>	85 lbs.	\$131.00
Factory setup .....	<b>SUDFB</b>		Net \$441.00
Hydraulic Height Adjuster for trailer and rear mount models (24" travel) .....	<b>9428009</b>	190 lbs.	\$1,263.00
Hydraulic Boom Leveling (for manual fold booms) .....	<b>DFHY</b>	28 lbs.	\$765.00
Wheel Assisted Boom Tip Protectors .....	<b>DFBTP</b>	27 lbs.	\$233.00
Fence Line Spray Kit, Electric .....	<b>9428002</b>	5 lbs.	\$185.00
Fence Line Spray Kit, Manual .....	<b>9428003</b>	5 lbs.	\$88.00

# 45' & 60' Hydraulic X-fold booms

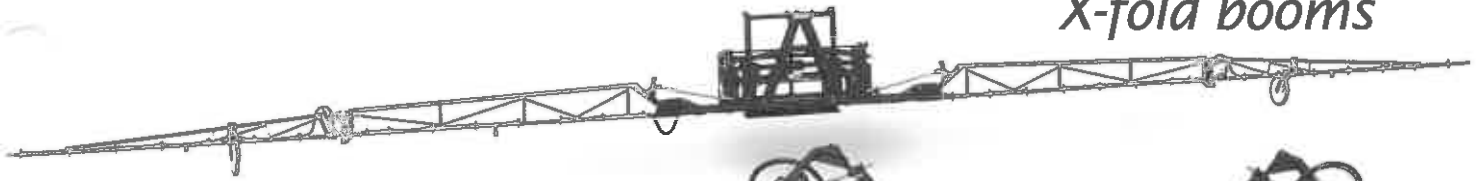

## Features

- The hydraulic X-fold boom requires two sets of remote outlets and has auto level ride and shock-spring flotation.
- Spring loaded cable ride for cushioning and less swing.
- Hydraulic boom wing leveling.
- Wings fold independently.
- Outer wing breakaway.
- Easy access to 3-point pins and hydraulic hookups.
- Available in three versions: 3-point tractor mount, trailer mount or rear mounted tank unit.
- Transport width: 10' 8"
- Transport height: 11' 9" (at a 20" spraying height)
- All booms are available with 3/4" high volume plumbing and TeeJet® drip free diaphragm check nozzles with stainless steel boom and hose clamps spaced at 20".
- Trailer mounts include hydraulic height adjuster (24" travel).

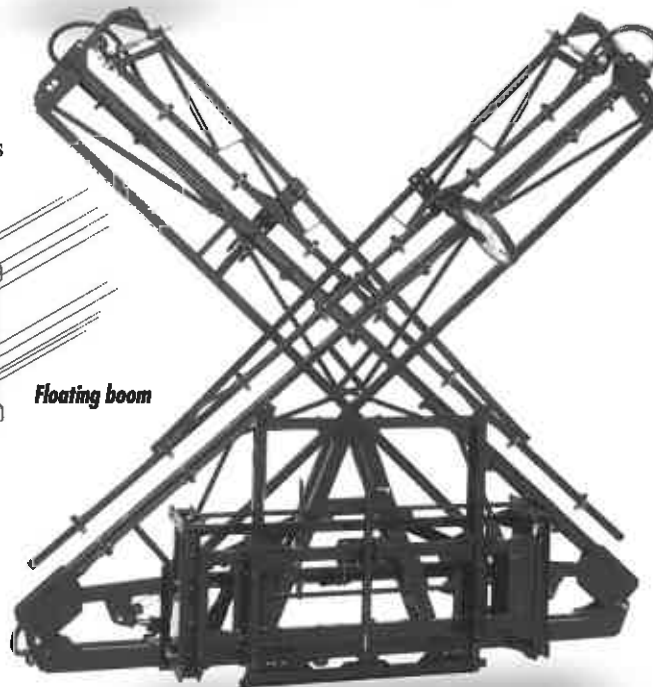
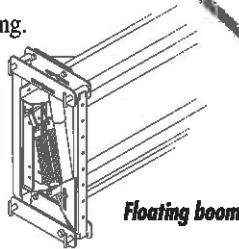

NOTE: Factory setup is standard. Wings may be removed for shipping.

### HOW TO ORDER 1. Choose Boom 2. Choose Boom Plumbing 3. Choose Accessories



#### Boom without Plumbing

NOTE: If a 60' boom is ordered, Demco recommends the 80-120" wheel spacing trailer.

45' Hydraulic X-Fold Boom 3-Point Mount .....	<b>9488065</b>	1225 lbs.	\$7,775.00
45' Hydraulic X-Fold Boom Rear Mount .....	<b>9488064</b>	1160 lbs.	\$7,539.00
45' Hydraulic X-Fold Boom Trailer Mount (Includes Height Adjuster) .....	<b>9488063</b>	1250 lbs.	\$10,155.00
60' Hydraulic X-Fold Boom 3-Point Mount .....	<b>9488071</b>	1275 lbs.	\$8,864.00
60' Hydraulic X-Fold Boom Rear Mount .....	<b>9488070</b>	1275 lbs.	\$8,628.00
60' Hydraulic X-Fold Boom Trailer Mount (Includes Height Adjuster) .....	<b>9488069</b>	1320 lbs.	\$11,244.00



#### Boom Plumbing

NOTE: Order Spray Tips separately (see Components section)

TeeJet® Drip Free (27 nozzles) for 45' Hydraulic X-Fold Boom .....	<b>9428024</b>	20 lbs.	\$952.00
TeeJet® Drip Free (37 nozzles) for 60' Hydraulic X-Fold Boom .....	<b>9428026</b>	25 lbs.	\$1,143.00
TeeJet® Triple Drip Free (27 nozzles) for 45' Hydraulic X-Fold Boom .....	<b>9428046</b>	23 lbs.	\$1,276.00
TeeJet® Triple Drip Free (37 nozzles) for 60' Hydraulic X-Fold Boom .....	<b>9428008</b>	28 lbs.	\$1,645.00



#### Accessories

3-Point Boom Storage Stand .....	<b>9488011</b>	75 lbs.	\$469.00
Hydraulic Height Adjuster for 3-point models (24' travel) .....	<b>9428107</b>	190 lbs.	\$2,039.00
Hydraulic Height Adjuster for rear mount models (24' travel) .....	<b>9428133</b>	210 lbs.	\$1,699.00
Wheel Assisted Boom Tip Protectors .....	<b>9488012</b>	27 lbs.	\$233.00
Fence Line Spray Kit, Electric .....	<b>9428002</b>	5 lbs.	\$185.00
Fence Line Spray Kit, Manual .....	<b>9428003</b>	5 lbs.	\$88.00
Light Kit .....	<b>9428084</b>	10 lbs.	\$329.00
LTL freight shipments require crating .....	<b>CRATE2</b>		Net \$100.00

# Lil' Thumper Ground Driven Pumps

5232



5230

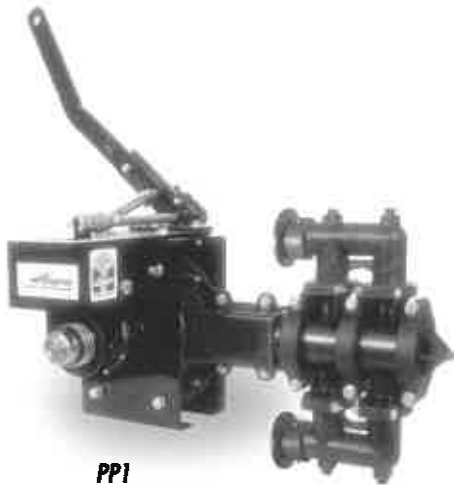

PP1

## Features

- Lil' Thumper piston pumps can be mounted on most planters and will adapt to other application equipment.
- Ground wheel drive assures accurate rate of application regardless of speed. Rate is easily set by dial pointer.
- Available with manually operated throw-out clutch, hydraulic clutch, or 12 volt electric clutch.
- Color coded reinforced synthetic valves with stainless steel springs and retainers. Stainless steel cage type valves virtually eliminate sticking and leaking and are easily serviced.
- All parts in contact with solution are various types of reinforced synthetic materials and stainless steel for unequalled corrosion resistance and years of service.
- Two self tightening stack-packing glands and drive case seals, with drain between, provide excellent crankcase protection.
- Single piston pump has 7.35 GPM output at 100 RPM full stroke. Double piston pump has 14.7 GPM output at 100 RPM full stroke. Maximum RPM 210. Maximum operating pressure 100 PSI. Recommended operating pressure 20 - 40 PSI.

NOTE: ANY AMOUNT OF LIQUID FERTILIZER, WITH OR WITHOUT ADDITIVES, MAY CAUSE GERMINATION DAMAGE WHEN PLACED IN DIRECT CONTACT WITH THE SEED.

*Injection molded case is made of durable du Pont™ Rynite® to resist corrosion from agricultural chemicals and clear liquid fertilizer. Eccentric drive system permits a variable application rate (see "PISTON PUMP" application rate chart). Eccentrics are specially machined 4140 steel bearing material. Case bolts, washers and nuts are stainless steel to resist corrosion.*

## LIL' THUMPER PISTON PUMPS MAXIMUM APPLICATION CAPACITIES

Based on a tire size with 15" loaded radius and 2:1 ratio.

Swath	Gallons Per Acre	
	PP1	PP2
15 ft.	0 - 78	0 - 156
20 ft.	0 - 58	0 - 116
25 ft.	0 - 47	0 - 94
30 ft.	0 - 39	0 - 78
35 ft.	0 - 33.5	0 - 67
40 ft.	0 - 29	0 - 58
45 ft.	0 - 26	0 - 52
50 ft.	0 - 23.5	0 - 47
60 ft.	0 - 18.5	0 - 37

To increase volume, increase sprocket ratio

### Single Piston Pumps

Lil' Thumper Single Piston 1.25" Diameter Solid Shaft .....	<b>5232</b>	52 lbs.	\$1,592.00
Lil' Thumper Single Piston with clutch, less Shut-off .....	<b>5230</b>	70 lbs.	\$1,765.00
Lil' Thumper Single Piston with manual shut-off .....	<b>PP1</b>	80 lbs.	\$1,753.00

### Double Piston Pumps

Lil' Thumper Double Piston 1.25" Diameter Solid Shaft only .....	<b>5233</b>	70 lbs.	\$2,426.00
Lil' Thumper Double Piston with manual shut-off .....	<b>PP2</b>	100 lbs.	\$2,552.00

Pump, tire and sprocket  
not included

### Ground Drive for Piston Pump

<b>PPGDW</b>	Ground Drive Wheel for Lil' Thumper Piston Pump Mounting for 7" X 7" tool bar. Includes chain, hub and necessary mounting hardware (less tire).	200 lbs.	\$1,394.00
<b>T590L</b>	Unit designed to be pushed, not pulled.	20 lbs. Net	\$76.00
<b>07209-30</b>	Traction Tire for Ground Drive Wheel (590 X 15") 18 tooth sprocket, 1 1/4" bore, #50 chain	4 lbs.	\$87.28

### Drive Packages

<b>PP6D</b>	Drive Package for 5 and 6 Bolt Hub	32 lbs.	\$374.00
-------------	------------------------------------	---------	----------

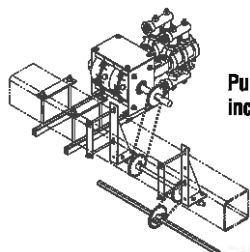

PP6D

Pump not  
included

### Lil' Thumper Pump Mounting

<b>5228</b>	Universal Mounting Kit for Planter Includes mounting rails, plates, four 28 tooth sprockets, 6 feet of # 40 roller chain w/ connecting link, jack shaft and all necessary hardware. <i>Note: Modifications may be necessary for some planters.</i>	51 lbs.	\$361.00
-------------	--	---------	----------



5228

### Drive Sprockets

<b>07325</b>	15 tooth sprocket, 1 1/4" bore, #40 chain	1 lbs.	\$43.72
<b>28TS 1-30</b>	28 tooth split sprocket for 7/8" hex shaft #40 chain	2 lbs.	\$57.58
<b>28TH 1 1/4-30</b>	28 tooth sprocket, 1 1/4" bore, #40 chain	2 lbs.	\$62.34
<b>07209-30</b>	18 tooth sprocket, 1 1/4" bore, #50 chain	4 lbs.	\$87.28



28TH 1/4-30



# Piston Pump Parts Breakdown

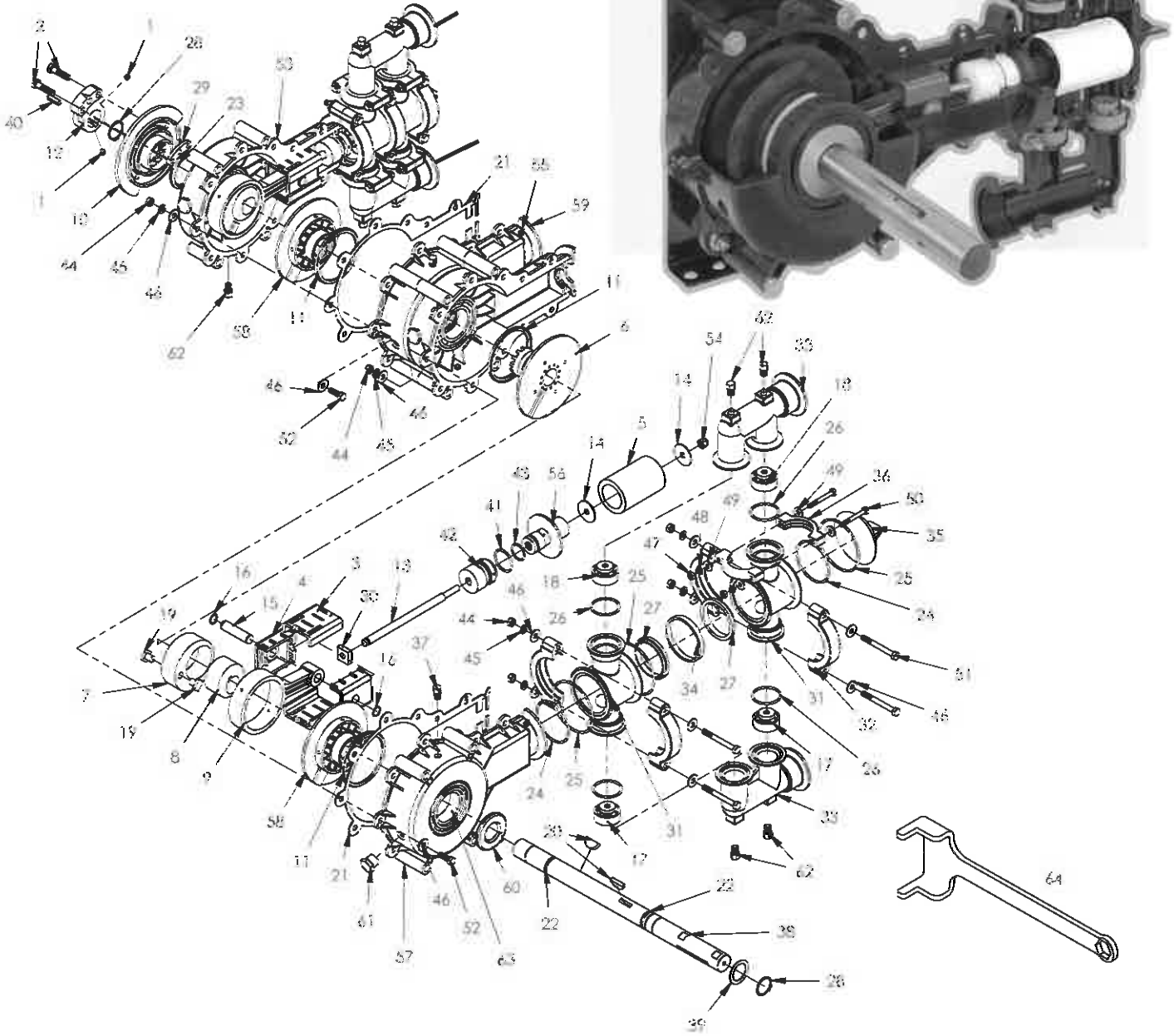

## PISTON PUMP PARTS LIST for pumps with serial numbers 250000 and larger

REF. PART NO.	DESCRIPTION	PRICE	REF. PART NO.	DESCRIPTION	PRICE	REF. PART NO.	DESCRIPTION	PRICE
1. 00087	Set Screw 3/8" X 1/2" Socket Head	\$0.52	23. 01517	Oil Seal	\$21.19	44. 01996	Nut, 3/8" NC SS	\$0.28
2. 00914	Bolt, 3/8" NC X 1.50 Hex Head GR.5	\$0.57	24. 01520	O-Ring Small Cylinder	\$3.27	45. 01997	Washer, Spring Lock 3/8"	\$0.11
3. 01166	Slide Cover	\$13.89	25. 01521	O-Ring Large Clamp	\$3.37	46. 01998	Washer, Flat, 3/8"	\$0.13
4. 01167	Piston Slide	\$31.89	26. 01522	O-Ring Check Valve	\$1.87	47. 01999	Washer, Flat, 3/8"	\$0.15
5. 01168	UHF/W Piston	\$92.25	27. 01524	Piston Wipe	\$14.06	48. 02001	Washer, 1/2" Spring Lock SS	\$0.05
6. 01169	Drive Hub Adjustment Side	\$90.87	28. 01528	Snap Ring (1.172" ID)	\$0.59	49. 02002	Washer, Flat, 3/8" SS	\$0.09
7. 01171	Eccentric, Large	\$211.32	29. 01528-95	Adjustment Pointer Locking Plate	\$18.42	50. 02004	Bolt, 1/2" NC X 2.25 SS	\$0.96
8. 01172	Eccentric, Small	\$143.23	30. 01530	Piston Rod Retaining Block	\$12.67	51. 02006	Bolt, 3/8" NC X 3 SS	\$1.60
9. 01173	Connecting Rod	\$130.60	31. 01534	Cylinder Housing	\$49.38	52. 02006	Bolt, 3/8" NC X 1.00 SS	\$0.83
10. 01176	Adjustment Disc	\$48.77	32. 01535	Large Clamp Half	\$8.64	53. 02200	Half Drive Case (Bearing Not Included)	\$136.73
11. 01177	Bearings Trust Drive Hub	\$10.71	33. 01536	Manifold (Intake/Exhaust)	\$63.70	54. 04632	Nut, 3/8" NC Nylon Lock	\$1.00
12. 01191-95	Adjustment Pointer	\$40.28	34. 01537	Support Ring Piston W/Per	\$3.20	55. 04642	Zerk, Grease, 1/2" UNF	\$0.40
13. 01265	Piston Rod	\$58.22	35. 01538	End Cap	\$12.67	56. 5136	Stack Pack Subassembly	\$155.80
14. 01313	Piston Washer	\$5.07	36. 01539	Small Clamp	\$4.46	57. 11924	Half Drive Case (Bearing Not Included)	\$136.73
15. 01317	Wrist Pin	\$21.44	37. 01597	Plug Breather, 1/2" MPT	\$2.57	58. 11926	Drive Hub Adjustment Side	\$67.46
16. 01318	Pump Snap Ring	\$0.33	38. 01596	Drive Shaft (PP1)	\$134.83	59. 11927	Center Drive Case	\$455.42
17. 01320	Intake Valve (Blue)	\$39.32	39. 01599	Drive Shaft (PP2)	\$221.80	60. 11929	Oil Seal (Drive Hub)	\$30.48
18. 01321	Exhaust Valve (Red)	\$39.32	40. 01979	1.25" Machine Bushing	\$0.58	61. F1200	FTG, Plug 1/2" MPT	\$0.80
19. 01380	Drive Hub Adjusting Pin	\$7.25	41. 01989	Adjustment Clamp Drive Key	\$1.23	62. F1400	FTG, Plug 1/2" MPT	\$0.39
20. 01391	Weldruff Key 1 1/4" X 1 1/4"	\$1.03	42. 01596	O-Ring Piston Rod Guide	\$134.83	63. 02501	Bearing, Drive Case	\$69.54
21. 01426	Gasket	\$26.11	43. 01992	Bushing	\$66.54	64. 11521-85	Pump Adjusting Tool	\$15.55
22. 01516	O-Ring Main Shaft	\$0.85						

# setting the piston pump rate for gallons per acre (GPA)

Calibrate your piston pump from our website: [www.demco-products.com](http://www.demco-products.com). Use "calibration" in the Keyword Search.

1. Measure and record drive wheel tire air pressure. Maintain pressure at all times.
2. Measure the distance from the surface of the ground to the center of the drive wheel. This is your **Loaded Radius**.

## Determining Sprocket Ratios for Piston Pumps

1. Count the number of teeth on the Drive Wheel Sprocket.
2. Count the number of teeth on the Driven Sprocket.
3. Divide the number of teeth on the Drive Sprocket by number of teeth on the Driven Sprocket to determine Sprocket Ratio.

## For Equipment With Jack Shafts.

1. Multiply the number of teeth on all Drive Sprockets together.
2. Multiply the number of teeth on all Driven Sprockets together.
3. Divide Drive Sprocket total by Driven Sprocket total which equals the Sprocket Ratio.

**Example** - (See Diagram A)

- (A) Drive Sprockets  $50 \times 28 = 1400$
- (B) Driven Sprockets  $24 \times 18 = 432$
- (C)  $\frac{1400}{432} = 3.24$

**NOTE:** On units with press wheels, the radius in inches of the drive wheel can be considered as the number of teeth on the drive sprocket and the radius of the press wheel can be considered as the number of teeth on the driven sprocket.



REF. NO.	PART NO.	QTY.	DESCRIPTION	PRICE
69.	01582	1 1	Piston Pump Rate Chart	\$13.68

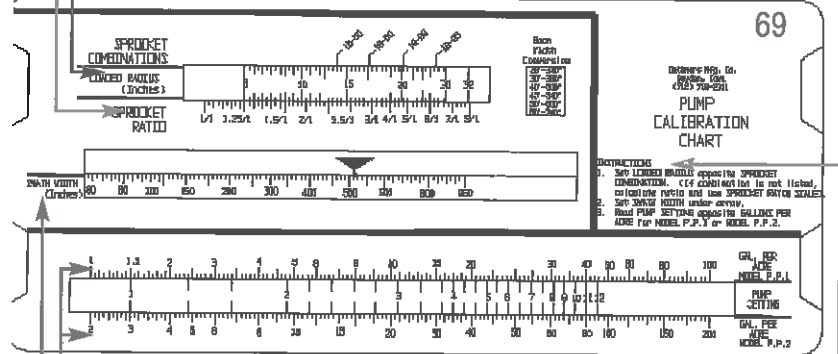

## Instructions for Pump Setting

1. Set **LOADED RADIUS** opposite **SPROCKET COMBINATION**. (If combination is not listed, calculate ratio and use **SPROCKET RATIO SCALE**).
2. Set **SWATH WIDTH** under arrow.
3. Read **PUMP SETTING** opposite **GALLONS PER ACRE** for **MODEL PP1** or **MODEL PP2**.

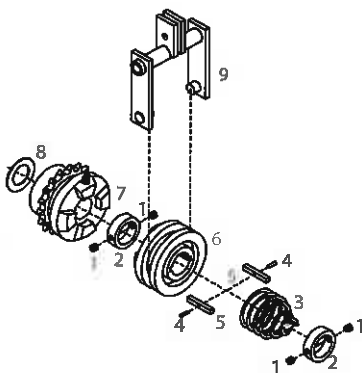
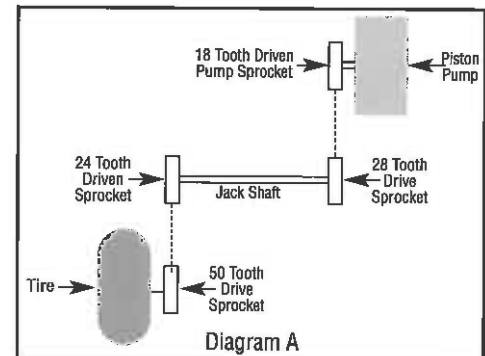

## PISTON PUMP CLUTCH PARTS

REF. NO.	PART NO.	DESCRIPTION	PRICE
1.	00087	3/8" x 3/8" Cup Point Set Screw	\$0.52
2.	01598-95	1 1/2" I.D. Lock Collar	\$15.91
3.	01193	Clutch Spring	\$7.41
4.	01976	1/2" x 1/2" Roll Pin	\$0.19
5.	01549	1/4" x 1/2" x 1 1/2" Key	\$3.48
6.	01184 1 1/4-30	1 1-1/2" I.D. Clutch Yoke	\$72.26
7.	01183 1 1/4-30	1 1-1/2" I.D. Sprocket Casting (18 tooth)	\$82.71
8.	01979	1-1/4" I.D. 18 Ga. Machine Washer	\$0.58
9.	01576-30	Clutch Throw Out Yoke	\$60.24

## PISTON PUMP PARTS KITS

PART. NO.	DESCRIPTION	PRICE
5224	<b>Wiper Repair Kit</b> (Requires 2 Kits for PP2) Consists of (2) Ref. 27 Wiper, (2) Ref. 24 O-Ring (3) Ref. 25 O-Ring (4) Ref. 26 O-Ring and (1) Ref. 43 O-Ring	\$35.92
5915	<b>Stack Pack &amp; Wiper Repair Kit</b> (Requires 2 Kits for PP2) Consists of (2) Ref. 27 Wiper, (2) Ref. 24 O-Ring (3) Ref. 25 O-Ring (4) Ref. 26 O-Ring and (1) Ref. 56 Stack Pack	\$206.53

# P-Series Polyethylene Tanks



Saddle bands and hardware are included.



Saddle bands and hardware are included.

**Round Tanks (without agitation)**

Gallons	Fitiwell	Outlet	Measurements
14	5"	1/2"	14" x 31"
55	5"	3/4"	23" x 37"
85	5"	3/4"	24" x 46"
110	5"	3/4"	24" x 59"
110	8"	1 1/4"	30" x 44"
150	8"	1 1/4"	30" x 56"
150	8"	1 1/4"	32" x 52"
200	8"	1 1/4 3/4"	32" x 65"

**Round Tanks (with agitation)**

55	5"	(1) 1 1/4"	23" x 37"
85	5"	(1) 1 1/4"	24" x 46"
110	5"	(1) 1 1/4"	24" x 59"
110	8"	(1) 1 1/4"	30" x 44"
150	8"	(1) 1 1/4"	30" x 56"
150	8"	(1) 1 1/4"	32" x 52"
200	8"	(1) 1 1/4"	32" x 65"

**Tank Saddles (for tank #)**

P25 23, P25 23A, P55 23, P55 23A  
 P85 24, P85 24A, P110 24, P110 24A  
 P110 30, P110 30A, P150 30, P150 30A  
 P200 32, P200 32A

**Elliptical Tanks (without agitation)**

150	10"	1 1/4"	24" x 38.5" x 56"
200	8"	1 1/4"	26" x 41" x 66"
300	8"	1 1/4"	30" x 48" x 70"
400	8"	1 1/4"	36" x 57" x 69"
500	8"	1 1/4"	36" x 57" x 82"
500	16"	1 1/4"	36" x 48" x 92"
1000	16"	2"	49" x 78" x 90"
1600	16"	2"	49" x 78" x 138"

**Elliptical Tanks (with agitation)**

150	10"	(1) 1 1/4"	38.5" x 24" x 56"
200	8"	(1) 1 1/4"	26" x 41" x 66"
300	8"	(1) 1 1/4"	30" x 48" x 70"
400	8"	(1) 1 1/4"	36" x 57" x 69"
500	8"	(1) 1 1/4"	36" x 57" x 82"
500	16"	(1) 2"	36" x 48" x 92"
1000	16"	(1) 2"	49" x 78" x 90"

**Tank Saddles (for tank #)**

PE150R, PE150RA  
 PE200R, PE200RA  
 PE300R, PE300RA  
 PE400R, PE400RA  
 PE500R, PE500RA  
 PE750, PE750A - Special Order, min of 10  
 PE1000, PE1000A - Special Order, min of 10  
 PE1600 - Special Order, min of 10

<b>P14 14</b> Ⓞ	11 lbs.	\$144.00
<b>P55 23</b> Ⓞ	20 lbs.	\$298.00
<b>P85 24</b> Ⓞ	29 lbs.	\$378.00
<b>P110 24</b> Ⓞ	40 lbs.	\$382.00
<b>P110 30</b> Ⓞ	40 lbs.	\$442.00
<b>P150 30</b> Ⓞ	50 lbs.	\$479.00
<b>P150 32</b> Ⓞ	50 lbs.	\$541.00
<b>P200 32</b> Ⓞ	64 lbs.	\$628.00

<b>P55 23A</b> Ⓞ	20 lbs.	\$348.00
<b>P85 24A</b> Ⓞ	29 lbs.	\$430.00
<b>P110 24A</b> Ⓞ	40 lbs.	\$434.00
<b>P110 30A</b> Ⓞ	40 lbs.	\$495.00
<b>P150 30A</b> Ⓞ	50 lbs.	\$534.00
<b>P150 32A</b> Ⓞ	50 lbs.	\$599.00
<b>P200 32A</b> Ⓞ	64 lbs.	\$701.00

<b>PS23</b>	14 lbs.	\$213.00
<b>PS24</b>	30 lbs.	\$311.00
<b>PS30</b>	40 lbs.	\$354.00
<b>PS232A</b>	80 lbs.	\$505.00

<b>PE150R</b> Ⓞ	55 lbs.	\$692.00
<b>PE200R</b> Ⓞ	85 lbs.	\$778.00
<b>PE300R</b> Ⓞ	120 lbs.	\$1,000.00
<b>PE400R</b> Ⓞ	135 lbs.	\$1,222.00
<b>PE500R</b> Ⓞ	180 lbs.	\$1,571.00
<b>PE500</b> ⓄⓄⓄ	188 lbs.	\$1,849.00
<b>PE1000</b> Ⓞ	300 lbs.	\$2,676.00
<b>PE1600</b> ⓄⓄⓄ	420 lbs.	\$3,948.00

<b>PE150RA</b> Ⓞ	55 lbs.	\$786.00
<b>PE200RA</b> Ⓞ	85 lbs.	\$951.00
<b>PE300RA</b> Ⓞ	120 lbs.	\$1,170.00
<b>PE400RA</b> Ⓞ	135 lbs.	\$1,398.00
<b>PE500RA</b> Ⓞ	180 lbs.	\$1,741.00
<b>PE500A</b> ⓄⓄⓄ	188 lbs.	\$2,025.00
<b>PE1000A</b> Ⓞ	350 lbs.	\$2,914.00

<b>PS150RA</b>	75 lbs.	\$453.00
<b>PS200RA</b>	80 lbs.	\$529.00
<b>PS300RA</b>	90 lbs.	\$572.00
<b>PS400RA</b>	128 lbs.	\$662.00
<b>PS500RA</b>	158 lbs.	\$747.00
<b>SKD750</b>	315 lbs.	\$1,270.00
<b>SKD1000</b>	380 lbs.	\$1,853.00
<b>SKD1600</b>	630 lbs.	\$2,983.00

Ⓞ Includes 16" Fliptop Manway. Ⓞ Includes Baffle. Ⓞ Shallow Sump. Ⓞ Deep Sump.

## Features

- Polyethylene chemical spray tanks are durable, convenient to use and easy to maintain.
- One piece molded construction eliminates leaks due to defective seams.
- All tanks include sump, molded gallonage markings, o-rings and polypropylene outlet fittings.
- Sprayer tanks include extra outlets and jet agitation needed for Demco sprayers.

# P-Series Polyethylene Tanks



Saddle bands and hardware are included.



## Cut-away Side Tanks (with agitation)

Gallons	Fillwell	Outlet	Measurements	Model	Weight	Price
200	8"	1 1/4"	24" X 54" X 46"	<b>PA200 24C</b> ①	84 lbs.	\$654.00
250	8"	1 1/4"	24" X 60" X 51"	<b>PA250 24C</b> ②	100lbs.	\$809.00



## Cut-away Side Tank Saddles

200 Gallon (PA200 24C)	<b>SA24 200</b>	88 lbs.	\$441.00
250 Gallon (PA250 24C)	<b>SA24 250</b>	92 lbs.	\$441.00



## Side Tanks (with agitation)

200	12"	1 1/4"	36" X 35" X 48"	<b>PC200A</b> ③	81 lbs.	\$664.00
300	16"	1 1/4"	36" X 35" X 69"	<b>PC300A</b> ①②③	130 lbs.	\$1,398.00



## Side Tanks (with agitation)

300	8"	1 1/4"	31" X 49" X 56"	<b>P300 31</b> ④	108 lbs.	\$1,026.00
-----	----	--------	-----------------	------------------	----------	------------

① Includes 16" Lid. ② Includes Baffle. ③ Shallow Sump. ④ Deep Sump.



## Side Tank Saddles

300 Gallon (P300 31)	<b>S31 300</b>	175 lbs.	\$524.00
----------------------	----------------	----------	----------



## SideQuest® Tanks (with 200 Flange outlet, 100 Flange agitation & saddle)

350 Yellow	16"	26" X 44" X 96"	<b>35631</b>	520 lbs.	\$3,299.00
350 Charcoal	16"	26" X 44" X 96"	<b>35631C</b>	520 lbs.	\$3,299.00
500 Yellow	16"	26" X 64" X 96"	<b>35632</b>	705 lbs.	\$4,245.00
500 Charcoal	16"	26" X 64" X 96"	<b>35632C</b>	705 lbs.	\$4,245.00



## SideQuest® Tanks (with 200 Flange outlet, 100 Flange agitation, saddle & shut-off Valve)

600 Yellow	16"	30" X 72" X 109"	<b>35747</b>	\$5,318.00
600 Charcoal	16"	30" X 72" X 109"	<b>35746C</b>	\$5,318.00

## Fresh Water Tank

2 1/2 Gallon Fresh Water Tank with Universal Mounting Bracket	<b>6054</b>	20 lbs.	\$90.47
---	-------------	---------	---------

# Centrifugal Sprayer Pumps

Components

HAMILTON

## Hypro® Gear-driven Centrifugal Pump

Viton® shaft seal standard. Cast iron body, molded nylon impeller. Planetary gear drive and bearings are factory lubricated. Ports: 1 1/2" NPT suction, 1 1/4" NPT discharge. Max. pressure: 80 PSI. Max. output: 106 GPM at open discharge at 20 PSI on 9006 & 9016. Max. output: 110 GPM at open discharge at 20 PSI on 9008, 9018 & 9028.

<b>C9006 540</b>	540 RPM tractor mounted pump. For 1 3/8" PTO. 47 GPM @ 60 PSI (540 RPM)	44 lbs.	\$1,062.00
<b>C9008 1000</b>	1000 RPM tractor mounted pump. For 1 3/8" PTO. 70 GPM @ 60 PSI (1000 RPM)	45 lbs.	\$1,102.00
<b>C9028 1000</b>	1000 RPM tractor mounted pump. For 1 3/4" PTO. 70 GPM @ 60 PSI (1000 RPM)	48 lbs.	\$1,278.00
<b>C9016 540</b>	540 RPM frame mounted pump. (1" diameter stub shaft) 47 GPM @ 60 PSI (540 RPM)	41 lbs.	\$1,048.00
<b>C9018 1000</b>	1000 RPM frame mounted pump. (1" diameter stub shaft) 70 GPM @ 60 PSI (1000 RPM)	42 lbs.	\$1,089.00
<b>5564</b>	Viton® Seal Repair Kit		\$58.70
<b>3430 0591</b>	Silicone Carbide Seal Repair Kit. Excellent Life Guard™ survivability		\$218.72



## Hypro® Belt-driven Centrifugal Pump

Includes 12 groove belt drive. The epoxy coating inside and out provides excellent protection from corrosion as well as a stainless steel shaft and Viton® mechanical seal.

<b>C9402 540S</b>	Cast iron 1 1/4" x 1" straight centrifugal pump, 600 RPM for 1" solid shaft. 54 GPM at 60 PSI (540 RPM).	45 lbs.	\$1,037.00
<b>C9402 540Q</b>	Cast iron 1 1/4" x 1" straight centrifugal pump, 600 RPM with 1 3/8" PTO, 6 spline, and quick coupler. 98 GPM at 60 PSI (540 RPM).	45 lbs.	\$1,037.00
<b>C9403B2</b>	Cast iron 1 1/2" x 1 1/4" straight centrifugal pump, 1000 RPM for 1 3/8" PTO. 21 spline. 98 GPM at 60 PSI.	42 lbs.	\$1,170.00
<b>C9403 1000L</b>	Cast iron 1 1/2" x 1 1/4" straight centrifugal pump, 1000 RPM for 1 3/4" PTO. 21 spline. 128 GPM at 60 PSI (1000 RPM).	42 lbs.	\$1,215.00
<b>C9403 540S</b>	Cast iron 1 1/2" x 1 1/4" straight centrifugal pump, 600 RPM for 1" solid shaft. 98 GPM at 60 PSI (540 RPM).	45 lbs.	\$1,170.00
<b>C9403B5</b>	Cast iron 1 1/2" x 1 1/4" straight centrifugal pump, 1000 RPM for 1" solid shaft. 128 GPM at 60 PSI.	42 lbs.	\$1,170.00
<b>5565</b>	Viton® Seal Repair Kit		\$64.03
<b>3430 0589</b>	Silicone Carbide Seal Repair Kit. Excellent Life Guard™ survivability		\$208.42
<b>3100 0005</b>	1000 RPM 12 Groove Belt		\$70.71
<b>3100 0006</b>	540 RPM 12 Groove Belt		\$95.30
<b>3103 0009</b>	540 RPM Cogged Belt F/9401 Series		\$76.98
<b>3103 0010</b>	1000 RPM Cogged Belt F/9401 Series		\$59.13



## Hypro® Centrifugal Pump with Hydraulic Motor

The Hypro® centrifugal pump is made of pressure tested epoxy coated cast iron housing with a closed-type, molded nylon impeller mounted on a hardened stainless steel shaft. The epoxy coating on the housing provides for superior internal chemical and abrasion resistance for longer pump life, as well as extra protection of the external surface of the pump. 180 PSI maximum spraying pressure. C9303HM2 includes a restrictor orifice. Standard Viton® shaft seals unless noted.

<b>C9303HM1</b>	8-15 GPM hydraulic motor with 1 1/2" x 1 1/4" cast iron pump. 104 GPM @ 60 PSI (3000 PSI maximum @ remote outlet)	26 lbs.	\$998.00
<b>C9303HM2</b>	4-8 GPM hydraulic motor with 1 1/2" x 1 1/4" cast iron pump. 50 GPM @ 60 PSI (3000 PSI maximum @ remote outlet)	26 lbs.	\$998.00
<b>C9303HM3</b>	15-23 GPM hydraulic motor with 1 1/2" x 1 1/4" cast iron pump. 76 GPM @ 60 PSI (3000 PSI maximum @ remote outlet)	26 lbs.	\$1,061.00
<b>C9314HM1</b>	10-20 GPM oil flow 2" x 2" for closed/open center systems. 120 PSI maximum pressure, 207 GPM @ 60 PSI. Includes Life Guard™ seal and 220 Flanged ports. (3000 PSI maximum @ remote outlet)	41 lbs.	\$1,311.00
<b>5565</b>	Viton® Seal Repair Kit		\$64.03
<b>3430 0589</b>	Silicone Carbide Seal Repair Kit. Excellent Life Guard™ survivability		\$208.42



# Centrifugal Sprayer Pumps

## Ace Belt-driven Centrifugal Pumps

With Pulleys, 10 groove belt and Viton® seals. 0-70 PSI. 1¼" suction x 1" discharge. Sprays 48 GPM at 40 PSI when driven by 540 RPM PTO.

<b>PTOC600 10QC</b>	Cast iron pump for direct mounting on 1 ¾" 600 RPM PTO shaft. Pump is equipped with quick coupler.	46 lbs.	\$1,120.00
<b>PTOC1000 10</b>	Cast iron pump for direct mounting on 1 ¾" 1000 RPM PTO shaft. Pump is equipped with 21 spline split PTO drive shaft & split ring locking collar.	43 lbs.	\$1,219.00
<b>PTOC600 10B</b>	Cast iron pump. 1" dia. stub shaft and integral mounting base for 600 RPM Tumblerod drive shaft.	42 lbs.	\$1,081.00
<b>FMC Mia</b>	Replacement cast iron pump	18 lbs.	\$552.00
<b>RKFMC</b>	Pump Seal Repair Kit		\$70.66
<b>BAC28 10</b>	540 RPM 10 Groove Belt		\$52.21
<b>BAC28 10M</b>	1000 RPM 10 Groove Belt		\$53.01



## Ace Belt-driven Centrifugal Pumps

With Pulleys, 10 groove belt and Viton® seals. High Performance. 0-100 PSI. 1½" suction x 1¼" discharge. Sprays 85 GPM at 40 PSI when driven by 540 RPM PTO.

<b>PTOC600QC150</b>	Cast iron pump for direct mounting on 1 ¾" 600 RPM PTO shaft. With quickcoupler.	51 lbs.	\$1,285.00
<b>PTOC600 10B150</b>	Cast iron pump. 1" dia. stub shaft and integral mounting base for 600 RPM Tumblerod drive shaft.	52 lbs.	\$1,254.00
<b>PTOC1000 175</b>	Cast iron pump for direct mounting on 1 ¾" 1000 RPM PTO shaft. With 20 spline PTO shaft & locking collar.	50 lbs.	\$1,285.00
<b>RKFMC150</b>	Pump Seal Repair Kit.		\$67.46
<b>BAC28 10 150</b>	540 RPM 10 Groove Belt.		\$65.85
<b>BAC28 10M150</b>	1000 RPM 10 Groove Belt.		\$47.64



## Ace Hydraulic Pumps

<b>FMCHYD204</b>	1 ½" x 1" frame mounted centrifugal, hydraulic driven pump. 0-100 PSI at max. 75 GPM at open discharge. Tractor hydraulic system must have 4-13 GPM of hydraulic fluid available to the sprayer pump from the tractor remote outlet (at 1000 PSI).	26 lbs.	\$1,136.00
<b>FMCHYD210</b>	1 ½" x 1" frame mounted centrifugal, hydraulic driven pump. 0-100 PSI at max. 75 GPM at open discharge. Tractor hydraulic system must have 8-17 GPM of hydraulic fluid available to the sprayer pump from the tractor remote outlet (at 1000 PSI).	27 lbs.	\$1,136.00
<b>FMC150HYD206</b>	1 ½" x 1¼" frame mounted centrifugal, hydraulic driven pump. 0-120 PSI at max. 100 GPM at open discharge. Tractor hydraulic system must have 7-16 GPM of hydraulic fluid available to the sprayer pump from the tractor remote outlet (at 1000 PSI).	31 lbs.	\$1,178.00
<b>FMC150HYD304</b>	1 ½" x 1¼" frame mounted centrifugal, hydraulic driven pump. 0-120 PSI at max. 100 GPM at open discharge. Tractor hydraulic system must have 7-16 GPM of hydraulic fluid available to the sprayer pump from the tractor remote outlet (at 1000 PSI). <b>Flanged ports &amp; silicon carbide seal.</b>	38 lbs.	\$1,402.00
<b>FMC200HYD304</b>	2" x 1 ½" frame mounted centrifugal, hydraulic driven pump. 0-120 PSI at max. 200 GPM at open discharge. Tractor hydraulic system must have 11-20 GPM of hydraulic fluid available to the sprayer pump from the tractor remote outlet (at 1000 PSI).	33 lbs.	\$1,331.00
<b>RKFMC</b>	Viton® Pump Seal Repair Kit.		\$70.66
<b>RKBAC75HYDL</b>	Hydraulic Orbit Motor Repair Kit. (for 204, 206, 210 only)		\$80.44
<b>RKBAC75HYD300L</b>	Hydraulic Orbit Motor Repair Kit. (for 304 motor only)		\$122.23

**TRACTOR HYDRAULIC REMOTE OUTLET CAPACITY (GPM)**

MODEL	CLOSED CENTER	OPEN CENTER
FMCHYD204	All	4-13
FMCHYD210	Load Sensing	8-17
FMC150HYD206	All	7-16
FMC200HYD304	11 GPM Minimum	11-20



# Parts

## Valves

Components

HAMILTON



SAFI 12 volt ball valve designed for remote on/off control of spray booms and nozzles at pressures to 300 PSI.

1/2 sec. response time from fully open to fully closed. Flanged inlet and outlet connections. 35 GPM of flow.

**12844** Valve with Packard \$390.59  
**13534** Motor with Packard \$252.85



TeeJet® Model 460 12 volt ball valve designed for remote on/off control of spray booms and nozzles at pressures to 300 PSI.

1/4 sec. response time from fully open to fully closed. Flanged inlet and outlet connections. 32 GPM of flow.

**09484** Valve with DIN \$515.98  
**10933** Valve with Packard \$519.57

### Repair Parts

**AB460** Seal Kit (SS ball included) \$214.90  
**AB460-1** Seal Kit (without ball) \$70.58  
**11233** Replacement Motor with DIN \$324.82  
**12095** Replacement Motor w/Packard (50515 Series) \$400.14

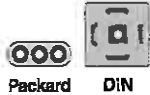

Packard DIN

Electrically operated 12 volt valve, with Viton® diaphragm seals, designed for remote on/off control of spray booms and nozzles at pressures to 100 PSI. Direct-O-Valve is suitable for wettable powder applications. 1/2" NPT (F) inlet and 1/2" NPT (F) outlet. 10 GPM of flow.



**144A1** \$232.94

EPDM Repair Kit **AB144A1** \$36.89

Viton® Repair Kit **AB144A1VI** \$55.18

12 volt worm gear drive plunger valve assembly. Flanged connections. Requires DIN electrical connection.



**463011 900** \$369.88

Electric butterfly valve provides remote pressure control. Features two-wire lead for use in 12VDC system. Maximum operating pressure of 100 PSI. 3/4" NPT (F) connections.



**244 3/4** \$204.76

Repair Kit **AB244** \$20.35

Electric butterfly valve provides remote pressure control. Features two-wire lead for use in 12VDC system. Maximum operating pressure of 100 PSI. 3/4" NPT (F) connections.



**01057** \$157.11



Electric solenoid valve provides remote pressure control. Features two-wire lead for use in 12VDC system. Maximum operating pressure of 175 PSI. 8 GPM. 3/4" NPT (F) connections.

**11635** \$155.38



Manually operated single valve. In open position, liquid is directed to spray line and excess will bypass through valve. 1/2" NPT (F) spray line connections. 150 PSI max. 12.5 GPM.

**6B1** \$60.44

Repair Kit **AB6B1** \$25.35



TeeJet® valve for selective control of three section boom sprayers at pressures up to 300 PSI. 3/4" inlet and outlet. Control lever may be set at any of seven indexed locations.

**AA171** \$153.53

Repair Kit **AB17** \$42.61

### Pressure Regulators

For regulating flow in systems where sensitive regulation is required. Pressures to 300 PSI.



**23120PP** 1/2" NPT connections (100 PSI) \$43.98

**23340PP** 3/4" NPT connections (150 PSI) \$43.98

### Pressure Gauges



**60GS** 2 1/2" SS 60 PSI \$20.79

**64GS** 4" SS 60 PSI \$41.69

**60GB** 2 1/2" Brass 60 PSI \$15.99

**100GB** 2 1/2" Brass 100 PSI \$21.39

**104GB** 4" Brass 100 PSI \$30.43

**164GS** 4" SS 160 PSI \$39.80

**160GS** 2 1/2" SS 160 PSI \$24.00

**160GB** 2 1/2" Brass 160 PSI \$15.99

**160GBF** 2 1/2" Brass Glycerine filled, 160 PSI \$27.22

**200GB** 2 1/2" Brass 200 PSI \$15.99



**164GBF** 4" Brass Glycerine filled, back port 160 PSI \$68.98

**909P0100** Glycerine filled, back port 100 PSI Arag® \$123.67



**12800** 4" Brass Glycerine filled, back port with mounting flange 160 PSI (50 Series sprayer) \$55.43

### Chemical Isolator Kits



**2250** For 5120 Console Texas Industrial Remcor \$96.35

**23800** For 3318 Console TeeJet® \$133.97



**Hose**



1/2" Clear Vinyl	<b>120</b>	\$1.46
3/4" Clear Vinyl	<b>340</b>	\$2.16
1" Clear Vinyl	<b>1000</b>	\$2.52
3/8" EPDM Rubber	<b>380RB</b>	\$0.89
1/2" EPDM Rubber	<b>120RB</b>	\$1.53
3/4" EPDM Rubber	<b>340RB</b>	\$1.68
1" EPDM Rubber	<b>1010RB</b>	\$5.20
1 1/4" EPDM Rubber	<b>1140RB</b>	\$5.30
1 1/2" EPDM Rubber	<b>1120RB</b>	\$6.26
1 1/4" Wire Suction	<b>S114</b>	\$13.86
1 1/2" Wire Suction	<b>S112</b>	\$15.79
2" Wire Suction	<b>S2020</b>	\$17.27

**Stainless Steel Hose Clamps with Stainless Steel Screw**



**B20H**

1/4"	<b>B4H</b>	\$1.37
3/8"	<b>B6H</b>	\$1.67
1/2"	<b>B8H</b>	\$1.77
3/4"	<b>B12H</b>	\$1.83
1"	<b>B20H</b>	\$1.99
1 1/4"	<b>B24H</b>	\$2.13
1 1/2"	<b>B32H</b>	\$2.29
2"	<b>B44H</b>	\$2.57
3"	<b>B64H</b>	\$3.07
7 1/2"	<b>B128H</b>	\$6.46

**2-Way Ball Valves**



**UV125FP**

1/2"	<b>UV050FP</b>	\$29.47
3/4"	<b>UV075FP</b>	\$29.47
1"	<b>UV100FP</b>	\$36.75
1 1/4"	<b>UV125FP</b>	\$63.47
1 1/2"	<b>UV150FP</b>	\$63.47
2"	<b>UV200FP</b>	\$79.12

**3-Way Ball Valves**



**UV125FP3**

1"	<b>UV100FP3</b>	\$58.93
1 1/4"	<b>UV125FP3</b>	\$61.23
1 1/2"	<b>UV150FP3</b>	\$52.07
2"	<b>UV200FP3</b>	\$92.04

**Ball Valves**



1 1/4" Ratchet	<b>4011 1 1/4R</b>	\$242.91
Seal Repair Kit	<b>5542</b>	\$219.13

**PTO Shafts**



26" Constant Velocity	<b>540 RPM</b> <b>03774</b>	<b>1000 RPM</b> <b>03874</b>	\$579.00
32" Constant Velocity	<b>05654</b>	<b>NA</b>	\$579.00
36" Standard	<b>00211</b>	<b>00469</b>	\$268.00

**Springs**



Cable Tension for X-Fold 5 7/8" X 3/4"	<b>07580</b>	\$4.64
Piston Pump Idler & DB12 Boom	<b>01564</b>	\$10.94
Boom Breakaway 13 7/16" X 1 7/8"	<b>00180-30</b>	\$27.41
Floating Boom 10 1/8" X 1 3/4"	<b>00200-30</b>	\$28.56
X-Fold Boom 10 1/8" X 1 3/4"	<b>07838-51</b>	\$42.06
Running Gear Tongue w/Insert 13 5/16" X 2"	<b>00306-30</b>	\$62.01

**Handguns**



15" Hand Spray Gun Repair Kit	<b>2AAL60</b> <b>AB2AAL</b>	\$142.36 \$20.97
-------------------------------	--------------------------------	---------------------

18" Hand Spray Gun with adjustable tip, 3/8" FPT Replacement tip

<b>12434</b>	\$44.93
<b>12496</b>	\$11.61

Lawn / Turf Gun with #3 Black Nozzle  
Nozzle only 1.5 Gray  
Nozzle only 3 Black  
Nozzle only 4 Red  
Repair Kit

<b>25660-3</b>	\$124.00
<b>25670-1.5</b>	\$17.61
<b>25670-3</b>	\$18.32
<b>25670-4</b>	\$17.61
<b>AB2566</b>	\$22.17

15" Hand Spray Gun	<b>12217</b>	\$23.08
--------------------	--------------	---------

# Parts

## Male Tapered Pipe Threads and Hose Barbs

Components

HAMILTON



**A3434**

1/4"	1/4"	A1414	\$0.72
1/4"	3/8"	A1438	\$0.48
1/4"	1/2"	A1412	\$0.50
3/8"	3/8"	A3838	\$0.50
3/8"	1/2"	A3812	\$0.52
1/2"	3/8"	A1238	\$0.99
1/2"	1/2"	BA1212	\$1.72
1/2"	3/4"	BA1234	\$1.90
3/4"	1/2"	BA3412	\$1.90
3/4"	3/8"	A3438	\$1.19
3/4"	3/4"	BA3434	\$1.90
3/4"	1"	A3410	\$0.74
1"	3/4"	BA1034	\$2.39
1"	1"	BA1010	\$2.39
1"	1 1/4"	BA1114	\$3.00
1 1/4"	3/4"	BA114 34	\$3.00
1 1/4"	1"	BA114 1	\$3.00
1 1/4"	1 1/4"	BA114	\$3.00
1 1/4"	1 1/2"	A114 112	\$3.91
1 1/2"	1 1/4"	BA112 114	\$4.65
1 1/2"	1 1/2"	BA112	\$4.91
1 1/2"	2"	BA112 200	\$8.18
2"	1 1/2"	BA200 112	\$7.80
2"	2"	A200	\$2.88



**A3410**

## Male Tapered Pipe Thread and Hose Barb Elbows



**BEL3434**

1/4"	1/4"	EL1414	\$1.20
1/4"	3/8"	EL1438	\$0.71
1/4"	1/2"	EL1412	\$0.75
3/8"	3/8"	EL3838	\$0.84
3/8"	1/2"	EL3812	\$1.37
1/2"	3/8"	EL1238	\$0.81
1/2"	1/2"	BEL1212	\$1.90
1/2"	3/4"	BEL1234	\$1.90
3/4"	1/2"	BEL3412	\$2.51
3/4"	3/4"	BEL3434	\$2.51
3/4"	1"	EL3410	\$1.74
1"	3/4"	BEL1034	\$3.16
1"	1"	BEL1010	\$3.16
1"	1 1/4"	BEL1 114	\$3.99
1 1/4"	3/4"	EL114 34	\$3.97
1 1/4"	1"	BEL114 1	\$3.99
1 1/4"	1 1/4"	BEL114	\$3.99
1 1/4"	1 1/2"	EL114 112	\$6.07
1 1/2"	1 1/4"	BEL112 114	\$10.85
1 1/2"	1 1/2"	EL112	\$5.16
2"	1 1/2"	BEL200 112	\$11.76
2"	2"	BEL200	\$10.43



**EL3410**

## Hose Barb Tees



**T34**

3/8"	T38	\$0.80
1/2"	T12	\$0.81
3/4"	T34	\$2.51
1"	T100	\$2.98
1 1/4"	T114	\$4.95
1 1/2"	T112	\$5.88
2"	T200	\$16.14

## Male Tapered Pipe Thread Nipples



**BM3400**

1/4"	1/4"	M1400	\$0.89
3/8"	3/8"	M3838	\$0.93
1/2"	1/4"	M1214	\$0.56
1/2"	3/8"	BM1238	\$1.10
1/2"	1/2"	M1200	\$0.53
3/4"	3/8"	M3438	\$1.11
3/4"	1/2"	M3412	\$1.17
3/4"	3/4"	BM3400	\$2.06
1"	3/4"	BM1034	\$3.75
1"	1"	BM1000	\$2.80
1 1/4"	1"	BM114 1	\$3.99
1 1/4"	1 1/4"	BM1140	\$2.80
1 1/2"	1 1/4"	BM112 114	\$4.20
1 1/2"	1 1/2"	BM1120	\$5.33
2"	1 1/2"	BM200 112	\$4.19
2"	2"	BM2000	\$6.14

## Reducer Bushings



**BRB112 114**

3/8"	1/4"	RB3814	\$0.93
1/2"	1/4"	RB1214	\$1.10
1/2"	3/8"	BRB1238	\$3.99
3/4"	1/8"	BRB3418	\$3.99
3/4"	1/4"	RB3414	\$1.21
3/4"	3/8"	RB3438	\$1.10
3/4"	1/2"	RB3412	\$1.74
1"	1/4"	BRB1014	\$4.20
1"	1/2"	RB1012	\$2.06
1"	3/4"	BRB1034	\$4.20
1 1/4"	3/4"	BRB114 34	\$4.20
1 1/4"	1"	BRB114 1	\$4.25
1 1/2"	1 1/4"	BRB112 114	\$5.58
2"	1"	BRB200 100	\$6.14
2"	1 1/4"	BRB200 114	\$6.14
2"	1 1/2"	RB200 112	\$4.91
3"	2"	RB300 200	\$13.11

## Hose Menders



**SHM3400**

1/4" X 1/4"	SHM1400	\$0.48
3/8" X 1/4"	SHM3814	\$0.81
3/8" X 3/8"	SHM3800	\$0.81
1/2" X 1/4"	SHM1214	\$0.50
1/2" X 3/8"	SHM1238	\$0.56
1/2" X 1/2"	SHM1200	\$0.50
1/2" X 3/4"	SHM1258	\$0.59
5/8" X 3/8"	SHM5838	\$0.56
5/8" X 5/8"	SHM5800	\$0.98
3/4" X 3/4"	SHM3400	\$1.48
1" X 1"	SHM1000	\$0.95
1 1/4" X 1 1/4"	SHM114	\$3.52
1 1/2" X 1 1/2"	SHM112	\$4.35
2" X 2"	SHM200	\$6.41

## Threaded Tees



**BTT114**

1/4"	TT14	\$3.03
1/2"	BTT12	\$6.26
3/4"	BTT34	\$6.73
1"	BTT100	\$9.50
1 1/4"	BTT114	\$11.11
1 1/2"	BTT112	\$16.10
2"	BTT200	\$16.75

**90° Street Elbows**



**BSE112**

1/4"	<b>SE14</b>	\$1.78
3/8"	<b>BSE38</b>	\$5.52
1/2"	<b>SE12</b>	\$2.42
3/4"	<b>BSE34</b>	\$5.97
1"	<b>SE100</b>	\$7.20
1 1/4"	<b>BSE114</b>	\$8.73
1 1/2"	<b>SE112</b>	\$7.85
2"	<b>SE200</b>	\$16.03

**Line Strainers & Screens**



**RVF114 40**

3/8" HB 80 mesh	<b>RVB38 80</b>	\$15.78
1/2" HB 80 mesh	<b>RVB12 80</b>	\$23.49
3/4" FPT 40 mesh	<b>RVF34 40</b>	\$29.34
3/4" FPT 80 mesh	<b>RVF34 80</b>	\$29.34
1" FPT 40 mesh	<b>RVF100 40</b>	\$65.13
1" FPT 80 mesh	<b>RVF100 80</b>	\$70.52
1 1/4" FPT 40 mesh	<b>RVF114 40</b>	\$65.13
1 1/4" FPT 80 mesh	<b>RVF114 80</b>	\$70.52
1 1/2" FPT 40 mesh	<b>RVF112 40</b>	\$58.40
1 1/2" FPT 80 mesh	<b>RVF112 80</b>	\$70.52

**Replacement Screens**

3/8" & 1/2" 80 mesh	<b>RVB80</b>	\$4.59
3/4" 40 mesh	<b>RVF340</b>	\$9.50
3/4" 80 mesh	<b>RVF380</b>	\$9.50
1" 40 mesh	<b>RVF140</b>	\$10.34
1" 80 mesh	<b>RVF180</b>	\$17.01
1 1/4" 40 mesh	<b>RVF1140</b>	\$11.88
1 1/4" 80 mesh	<b>RVF1180</b>	\$18.15
1 1/2" 40 mesh	<b>RVF1240</b>	\$15.41
1 1/2" 80 mesh	<b>RVF1280</b>	\$24.41

**Replacement Gaskets**

3/8" & 1/2"	<b>RVB38GE</b>	\$1.48
3/4"	<b>RVF34GV</b>	\$6.59
1", 1 1/4" & 1 1/2"	<b>RVF114GV</b>	\$9.29

**Y-Strainers**

3/4" FPT 40 mesh	<b>LS075 40</b>	\$46.99
3/4" FPT 60 mesh	<b>LS075 60</b>	\$52.64
3/4" FPT 80 mesh	<b>LS075 80</b>	\$52.64
1" FPT 40 mesh	<b>LS100 40</b>	\$51.61
1" FPT 80 mesh	<b>LS100 80</b>	\$58.84
1 1/4" FPT 40 mesh	<b>LS125 40</b>	\$50.11
1 1/4" FPT 80 mesh	<b>LS125 80</b>	\$58.84
1 1/2" FPT 50 mesh	<b>LS150 50</b>	\$113.21
1 1/2" FPT 80 mesh	<b>LS150 80</b>	\$113.21
2" FPT 50 mesh	<b>LS200 50</b>	\$113.21
2" FPT 80 mesh	<b>LS200 80</b>	\$113.20

**Replacement Screens**

3/4" 60 mesh	<b>LS760</b>	\$23.44
3/4" 80 mesh	<b>LS780</b>	\$25.40
1" & 1 1/4" 40 mesh	<b>LS140</b>	\$25.40
1" & 1 1/4" 80 mesh	<b>LS180</b>	\$19.05
1 1/2" & 2" 20 mesh	<b>LS220</b>	\$49.46
1 1/2" & 2" 50 mesh	<b>LS250</b>	\$54.42
1 1/2" & 2" 80 mesh	<b>LS280</b>	\$54.42

**Replacement Gaskets**

3/4"	<b>LS075G</b>	\$4.86
1" & 1 1/4"	<b>LS100G</b>	\$5.09
1 1/2" & 2" O-ring	<b>LS150G</b>	\$5.09
1 1/2" & 2" Square	<b>LS200G</b>	\$5.68

**Quick Couplers**



**633A2020**

1 1/4"	<b>633A114</b>	\$8.39
1 1/2"	<b>633A112</b>	\$9.89
2"	<b>633A2020</b>	\$11.54



**633B2020**

1"	<b>633B1</b>	\$22.01
1 1/4"	<b>633B114</b>	\$20.54
1 1/2"	<b>633B112</b>	\$26.66
2"	<b>633B2020</b>	\$30.69



**633C2020**

1"	<b>633C1</b>	\$22.01
1 1/4"	<b>633C114</b>	\$18.56
1 1/2"	<b>633C112</b>	\$26.66
2"	<b>633C2020</b>	\$30.69



**633D2020**

1 1/4"	<b>633D114</b>	\$22.01
1 1/2"	<b>633D112</b>	\$26.67
2"	<b>633D2020</b>	\$32.56



**633E2020**

1"	<b>633E1</b>	\$10.09
1 1/4"	<b>633E114</b>	\$10.09
1 1/2"	<b>633E112</b>	\$10.43
2"	<b>633E2020</b>	\$13.86



**633F2020**

1"	<b>633F1</b>	\$10.09
1 1/4"	<b>633F114</b>	\$8.51
1 1/2"	<b>633F112</b>	\$10.43
2"	<b>633F2020</b>	\$13.86



**634A2020**

1" & 1 1/4"	<b>634A1</b>	\$9.10
1 1/2"	<b>634A112</b>	\$10.09
2"	<b>634A2020</b>	\$13.59



**634B2020**

1" & 1 1/4"	<b>634B114</b>	\$22.01
1 1/2"	<b>634B112</b>	\$26.66
2"	<b>634B2020</b>	\$30.69



1"	<b>100G</b>	\$2.56
1 1/2"	<b>112G</b>	\$1.75
2"	<b>200G</b>	\$1.90

# Parts

## Gaskets

		<b>OD</b>		
	1" flange	1.5"	<b>M100G</b>	\$3.01
	2" flange	2.375"	<b>112G</b>	\$1.75
	2" full port flange	2.5"	<b>200G</b>	\$1.90
	3" flange		<b>300G</b>	\$2.57

## Clamps

				
	1'		<b>09938</b>	\$12.25
	2'		<b>09939</b>	\$14.06
	2" Full Port		<b>09940</b>	\$16.09
	3'		<b>12030</b>	\$15.36

## End Plugs

				
	1"		<b>FF100</b>	\$3.01
	2"		<b>FF200</b>	\$6.28
	2" Full Port		<b>FF220</b>	\$7.98

## Flanged and Hose Barbs

				
	1" flange x 1" hose		<b>FA100 100HB</b>	\$2.67
	2" flange x 1" hose		<b>FA200 100HB</b>	\$7.14
	2" flange x 1 1/4" hose		<b>FA200 125HB</b>	\$13.27
	2" flange x 1 1/2" hose		<b>FA200 150HB</b>	\$7.14
	2" flange x 2" hose		<b>FA200 200HB</b>	\$7.14
	2" flange full port x 2" hose		<b>FA220 200HB</b>	\$6.43
	3" flange x 3" hose		<b>FA300 300HB</b>	\$23.02

## Flanged and Hose Barb Elbows

				
	1" flange x 1" hose		<b>FEL100 100HB</b>	\$3.27
	2" flange x 1" hose		<b>FEL200 100HB</b>	\$13.24
	2" flange x 1 1/4" hose		<b>FEL200 125HB</b>	\$13.24
	2" flange x 1 1/2" hose		<b>FEL200 150HB</b>	\$13.28
	2" flange x 2" hose		<b>FEL200 200HB</b>	\$13.28
	2" flange full port x 1 1/2" hose		<b>FEL220 150HB</b>	\$13.24
	2" flange full port x 2" hose		<b>FEL220 200HB</b>	\$13.24
	3" flange x 3" hose		<b>FEL300 300HB</b>	\$61.50

## Flanged and Flange Couplings

				
	1" flange x 1" flange		<b>FA100</b>	\$7.14
	2" flange x 1" flange		<b>FA200 100</b>	\$21.39
	2" flange x 2" flange		<b>FA200</b>	\$18.82
	3" flange x 2" flange full port		<b>FA300 220</b>	\$48.16

## Flanged and Flange Elbows

				
	2" flange x 2" flange		<b>FEL200</b>	\$16.71
	2" flange full port x 2" flange full port		<b>FEL220</b>	\$16.71

## Flanged Cross

				
	2" flange		<b>FCR200</b>	\$48.33

## Flanged Tees

				
	1" x 2" x 2" flanges		<b>FT100 200</b>	\$18.53
	2" x 2" x 2" flanges		<b>FT200</b>	\$19.33
	2" x 2" x 2" flanges full port		<b>FT220</b>	\$19.33

## Flanged and Male Pipe Threads

				
	1" flange x 1" MPT		<b>FA100 100MPT</b>	\$3.04
	2" flange x 1 1/4" MPT		<b>FA200 125MPT</b>	\$6.31
	2" flange x 1 1/2" MPT		<b>FA200 150MPT</b>	\$6.31
	2" flange x 2" MPT		<b>FA200 200MPT</b>	\$6.32
	2" flange full port x 2" MPT		<b>FA220 200MPT</b>	\$7.13

## Flanged Ball Valves

				
	1" full port		<b>MV100CF</b>	\$62.91
	2"		<b>MV200CF</b>	\$88.99
	2" full port		<b>MV220CF</b>	\$118.58

## Flanged 3-Way Ball Valves

				
	2" 3-way, bottom load		<b>FV200BLCF</b>	\$112.78
	2" 3-way, full port side load		<b>FV220SLCF</b>	\$168.57

## Stubby 2-Way Ball Valves

				
	2" coupler x 2" hose barb		<b>VSFHB 200</b>	\$89.87
	2" coupler x 2" FPT		<b>VSF204FP</b>	\$91.97
	2" coupler x 2" flange		<b>MVSF200CF</b>	\$74.77
	3" coupler x 3" flange		<b>MVSF 300</b>	\$187.83

## Flanged Strainers

				
	1 1/2" flange strainer with screen		<b>FLST150 50</b>	\$79.53
	Gasket (TeeJet®)		<b>11537</b>	\$6.28
	Gasket Bottom Cap		<b>14485</b>	\$3.95
	50 mesh screen (TeeJet®)		<b>11538</b>	\$26.51
	Gasket (Banjo®)		<b>LST150GV</b>	\$12.03
	50 mesh screen (Banjo®)		<b>LST1550</b>	\$35.95

# Spray Nozzle Accessories

## Drip Free Check Valves



<b>DF12NTL</b>	1/2" nozzle elbow & check valve assembly	\$11.38
<b>DF12NTT</b>	1/2" nozzle tee & check valve assembly	\$11.38
<b>DF34NTL</b>	3/4" nozzle elbow & check valve assembly	\$11.38
<b>DF34NTT</b>	3/4" nozzle tee & check valve assembly	\$11.38
<b>DFDV</b>	Replacement Viton® Diaphragm	\$1.61
<b>DFCP</b>	Replacement Diaphragm Cap Assembly	\$4.68
<b>DFGE</b>	EPDM Tip Cap Gasket	\$0.62
<b>DFFD</b>	Floodjet Cap (red)	\$1.10
<b>DFFT</b>	Flat Cap (yellow)	\$1.10

## TEEJET® Nozzle Body Series for Disc, Planter

### Banding & Pressure Hose Kits



<b>10913</b>	1/2" Single End Nozzle Assembly (less cap & gasket)	\$9.06
<b>10914</b>	1/2" Single Tee Nozzle Assembly (less cap & gasket)	\$9.06
<b>21953VI</b>	Replacement Diaphragm - Viton®	\$1.83
<b>21950 10PP</b>	Replacement Diaphragm Cap Assembly	\$4.50

## TEEJET® Nozzle Body Series for Dry Booms



<b>09147</b>	3/4" Single End Nozzle Assembly (less cap & gasket)	\$10.67
<b>09148</b>	3/4" Single Tee Nozzle Assembly (less cap & gasket)	\$10.67
<b>09310</b>	1/2" Single End Nozzle Assembly (less cap & gasket)	\$10.67
<b>09311</b>	1/2" Single Tee Nozzle Assembly (less cap & gasket)	\$10.67

## TEEJET® 360° Nozzle Body Series for Wet or Dry Booms



<b>07782</b>	360° Triple End Nozzle Assembly 3/4" Hose Barb (less caps & gaskets)	\$26.30
<b>07783</b>	360° Triple Tee Nozzle Assembly 3/4" Hose Barb (less caps & gaskets)	\$26.30
<b>21953VI</b>	Replacement Diaphragm - Viton®	\$1.83

## Caps & Gaskets for TEEJET® Nozzle Bodies



Cap & Gasket

<b>07787</b>	Flat Fan Red Cap w/EPDM gasket	\$1.46
<b>07788</b>	Flat Fan Blue Cap w/EPDM gasket	\$1.46
<b>07789</b>	Flat Fan Brown Cap w/EPDM gasket	\$1.46
<b>07790</b>	Flood Jet Green Cap w/EPDM gasket	\$1.46
<b>09692</b>	Air Induction Yellow Cap w/EPDM gasket	\$1.46
<b>19438EPR</b>	EPDM Tip Cap gasket	\$0.61

## Nozzle Bodies



<b>NLT38</b>	3/8" Elbow (less cap)	\$2.70
<b>NLT12</b>	1/2" Elbow (less cap)	\$3.01
<b>NLT34</b>	3/4" Elbow (less cap)	\$3.00
<b>NTT38</b>	3/8" Tee (less cap)	\$2.79
<b>NTT12</b>	1/2" Tee (less cap)	\$3.01
<b>NTT34</b>	3/4" Tee (less cap)	\$4.05
<b>8027</b>	Nozzle Body Cap	\$1.17

## DEMCO Clamps



<b>10862</b>	Demco stainless steel boom clamp for TeeJet® nozzle. Fits square tube. Requires worm gear style hose clamp. (2 required) each	\$4.19
<b>B24H</b>	Worm gear all stainless steel hose clamp	\$2.13

## Diamond Boom Clamp Assemblies



<b>09792</b>	Demco Stainless Steel boom clamp for TeeJet® nozzle. Fits 3" diamond tube. Requires worm gear style hose clamp. (2 required) each	\$6.50
<b>B64H</b>	Worm Gear all Stainless Steel hose clamp	\$3.07

## TEEJET® Vari-spacing Clamp Assemblies



Vari-Spacing Stainless Steel clamps for use on all dry boom Quick TeeJet® bodies.		
<b>10902</b>	1" square boom clamp	\$7.38
<b>10903</b>	1 1/4" square boom clamp	\$7.68
<b>10904</b>	1 1/2" square boom clamp	\$7.68

## Square Boom Clamp Assemblies



For use with NTL or NTT nozzle fittings. Available in 1" or 1 1/4", for square boom tubing.

<b>B11 1</b>	1" square boom clamp	\$3.74
<b>B11 114</b>	1 1/4" square boom clamp	\$3.74

## Round Boom Clamp Assemblies



For use with NTL or NTT nozzle fittings. Available in 3/4" or 1", for round boom tubing.

<b>B11 34R</b>	3/4" round boom clamp	\$3.74
<b>B11 1R</b>	1" round boom clamp	\$3.74

# Spray Tips

## FullJet®

WIDE ANGLE FLAT SPRAY TIPS AND NOZZLES  
FLOODJET® TIPS AND NOZZLES



TK & TKVS  
Floodjet Tip

FloodJet® tips and nozzles project a wide angle spray pattern. They are designed for incorporating herbicides into the soil. These tips are recommended for suspension and slurry type chemicals at lower spraying pressures. FloodJet® tips produce coarser particle sprays to minimize drift. Boom heights should be adjusted to obtain the overlap which provides the most uniform distribution. Optimum coverage is achieved by overlapping adjacent spray patterns 50% on each side to obtain double coverage. TK floodjet® tips are available in brass or stainless steel with VisiFlo color coding. KSS floodjet® nozzles are available in stainless steel. Fits into 07790 cap assembly.

## TeeJet®

Flat spray tips  
80 & 110 degree SERIES

Flat spray tips can be used for spraying herbicides, insecticides, fertilizers and other chemicals. Each tip produces a tapered edge spray pattern for uniform coverage where patterns overlap. Tips having an 80 degree spray pattern are available in brass, stainless steel, extended range color coded nylon with stainless steel orifice. Nozzle spacing is 20" and spray height is 17" to 19". Fits into 07787, 07788 or 07789 cap assemblies.

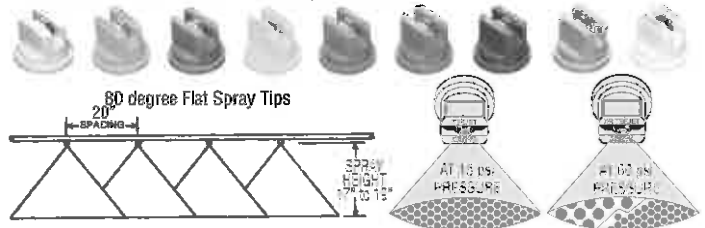

80 & 110 degree FLAT SPRAY TIPS  
(Based on 20" spacing)

Components

HAMILTON

Tip No.	Liquid Pressure In PSI	Nozzle Capacity In GPM	Degree Spray Angle	Gallons Per Acre 40" Spacing							
				4 MPH	5 MPH	6 MPH	8 MPH	10 MPH	12 MPH		
TK1 ① TKSS1 ①	10	10	80	3.7	3.0	2.5	1.9	1.5	1.2		
	20	14	109	5.3	4.2	3.5	2.6	2.1	1.8		
	30	17	118	6.4	5.1	4.3	3.2	2.6	2.1		
	40	20	123	7.4	5.9	5.0	3.7	3.0	2.5		
AN1.5 ② TK1.5 ②	10	.15	85	5.6	4.5	3.7	2.8	2.2	1.9		
	20	.21	108	7.9	6.3	5.3	3.9	3.2	2.6		
	30	.26	116	9.7	7.7	6.4	4.8	3.9	3.2		
	40	.30	121	11.1	8.9	7.4	5.6	4.5	3.7		
TK2 ① TKVS2 ② (Red)	10	20	95	7.4	5.9	5.0	3.7	3.0	2.5		
	20	28	113	10.5	8.4	7.0	5.3	4.2	3.5		
	30	35	121	12.9	10.3	8.6	6.4	5.1	4.3		
	40	40	125	14.9	11.9	9.9	7.4	5.9	5.0		
TK2.5 ① TKVS2.5 ② (Brown)	10	.25	110	9.3	7.4	6.2	4.6	3.7	3.1		
	20	.35	122	13.1	10.5	8.8	6.6	5.3	4.4		
	30	.43	126	16.1	12.9	10.7	8.0	6.4	5.4		
	40	.50	129	18.6	14.9	12.4	9.3	7.4	6.2		
TK3 ③ TKVS3 ③ (Gray)	10	30	96	11.1	8.9	7.4	5.6	4.5	3.7		
	20	42	112	15.8	12.6	10.5	7.9	6.3	5.3		
	30	52	115	19.3	15.4	12.9	9.7	7.7	6.4		
	40	60	120	22	17.8	14.9	11.1	8.9	7.4		
TK4 ④ TKVS4 ④ (White)	10	.40	107	14.9	11.9	9.9	7.4	5.9	5.0		
	20	.57	123	21	16.8	14.0	10.5	8.4	7.0		
	30	.69	125	26	21	17.2	12.9	10.3	8.6		
	40	.80	129	30	24	19.6	14.9	11.9	9.9		
TK5 ① TKVS5 ② (Lt. Blue)	10	50	120	18.6	14.9	12.4	9.3	7.4	6.2		
	20	71	128	26	21	17.5	13.1	10.5	8.8		
	30	87	134	32	26	21	16.1	12.9	10.7		
	40	1.0	137	37	30	25	18.6	14.9	12.4		
TK7.5 ① TKVS7.5 ② (Lt. Green)	10	.75	106	28	22	18.6	13.9	11.1	9.3		
	20	1.1	119	39	32	26	19.7	15.8	13.1		
	30	1.3	125	48	39	32	24	19.3	16.1		
	40	1.5	128	56	45	37	28	22	18.6		
TK10 ① TKVS10 ② (Black)	10	1.0	121	37	30	25	18.6	14.9	12.4		
	20	1.4	133	53	42	35	26	21	17.5		
	30	1.7	136	64	51	43	32	26	21		
	40	2.0	141	74	59	50	37	30	25		
TK15 ① TKSS15 ①	10	1.5	106	56	45	37	28	22	18.6		
	20	2.1	113	79	63	53	39	32	26		
	30	2.6	117	96	77	64	48	39	32		
	40	3.0	120	111	89	74	56	45	37		
TK20 ① TKSS20 ①	10	2.0	113	74	59	50	37	30	25		
	20	2.8	122	105	84	70	53	42	35		
	30	3.5	126	129	103	86	64	51	43		
	40	4.0	128	149	119	99	74	59	50		
TK30 ① TKSS30 ①	10	3.0	104	111	89	74	56	45	37		
	20	4.2	110	158	126	105	79	63	53		
	30	5.2	113	193	154	129	96	77	64		
	40	6.0	116	223	178	149	111	89	74		

If the nozzle spacing on your boom is different than those in the chart above, you must multiply the tabulated or calculated GPA coverage by one of the conversion factors in the table below.

Where Tables are Based on 40" Nozzle Spacing

Other Spacing	28"	30"	32"	34"	36"	38"	42"	44"	48"
Conversion Factor	1.43	1.33	1.25	1.18	1.11	1.05	.95	.91	.83

### PLUG TIP BLANKS



To temporarily shut off selected nozzles, replace spray tips with these plug tips. Easy, quick way to change spacing of operating nozzles on boom.

Order No.	Price	Material
3942SS	\$0.86	Stainless Steel

Tip No.	Liquid Pressure In PSI	Capacity 1 Nozzle In GPM	Gallons Per Acre							
			4 MPH	5 MPH	6 MPH	7 MPH	8 MPH	10 MPH	12 MPH	
800067 ①	20	.05	3.5	2.8	2.4	2.0	1.8	1.4	1.2	
	25	.055	3.9	3.2	2.6	2.3	2.0	1.6	1.3	
	30	.06	4.3	3.5	2.9	2.5	2.2	1.7	1.4	
	40	.067	5.0	4.0	3.3	2.8	2.5	2.0	1.7	
	50	.07	5.6	4.5	3.7	3.2	2.8	2.2	1.9	
	60	.08	6.1	4.9	4.1	3.5	3.1	2.4	2.0	
	15	.06	4.6	3.6	3.0	2.6	2.3	1.8	1.5	
	20	.07	5.3	4.2	3.5	3.0	2.6	2.1	1.8	
8001 ① XR8001VS ②	25	.08	5.9	4.7	3.9	3.4	2.9	2.4	2.0	
	30	.09	6.4	5.1	4.3	3.7	3.2	2.6	2.1	
	40	.10	7.4	5.9	5.0	4.2	3.7	3.0	2.5	
	50	.11	8.3	6.6	5.5	4.7	4.2	3.3	2.8	
	60	.12	9.1	7.3	6.1	5.2	4.6	3.6	3.0	
	15	.09	6.7	5.5	4.5	3.9	3.4	2.7	2.2	
	20	11	7.9	6.3	5.3	4.5	3.9	3.2	2.6	
	25	12	8.8	7.0	5.9	5.0	4.4	3.5	2.9	
80015 ③	30	13	9.7	7.7	6.4	5.5	4.8	3.9	3.2	
	40	15	11.1	8.9	7.4	6.4	5.6	4.5	3.7	
	50	17	12.5	10.0	8.3	7.1	6.2	5.0	4.2	
	60	18	13.6	10.9	9.1	7.8	6.8	5.5	4.6	
	15	12	8.9	7.3	6.1	5.2	4.5	3.6	3.0	
	20	14	10.5	8.4	7.0	6.0	5.3	4.2	3.5	
	25	16	11.7	9.4	7.8	6.7	5.9	4.7	3.9	
	30	17	12.9	10.3	8.6	7.4	6.4	5.1	4.3	
8002 ① XR8002VS ②	40	20	14.9	11.9	9.9	8.5	7.4	5.9	5.0	
	50	23	16.6	13.3	11.1	9.5	8.3	6.6	5.5	
	60	25	18.2	14.6	12.1	10.4	9.1	7.3	6.1	
	15	18	13.4	10.9	9.1	7.8	6.8	5.4	4.5	
	20	21	15.8	12.6	10.5	9.0	7.9	6.3	5.3	
	25	24	17.6	14.1	11.7	10.1	8.8	7.0	5.9	
	30	26	19	15.4	12.9	11.0	9.7	7.7	6.4	
	40	30	22	17.8	14.9	12.7	11.1	8.9	7.4	
8003 ① XR8003VS ②	50	34	25	19.9	16.6	14.2	12.5	10.0	8.3	
	60	37	27	22	18.2	15.6	13.6	10.9	9.1	
	15	24	17.8	14.5	12.1	10.4	9.1	7.2	6.0	
	20	28	21	16.8	14.0	12.0	10.5	8.4	7.0	
	25	32	23	18.8	15.7	13.4	11.7	9.4	7.8	
	30	35	26	21	17.2	14.7	12.9	10.3	8.6	
	40	40	30	24	19.8	17.0	14.9	11.9	9.9	
	50	45	33	27	22	19.0	16.6	13.3	11.1	
8004 ① XR11004VK ⑥	60	49	36	29	24	21	18.2	14.6	12.1	
	15	31	23	18.2	15.2	13.0	11.4	9.2	7.7	
	20	35	26	21	17.5	15.0	13.1	10.5	8.8	
	25	40	29	23	19.6	16.8	14.7	11.7	9.8	
	30	43	32	26	21	18.4	16.1	12.9	10.7	
	40	50	37	30	25	21	18.6	14.9	12.4	
	50	56	42	33	28	24	21	16.6	13.8	
	60	61	45	36	30	26	23	18.2	15.2	
8005 ① XR8005VS ②	15	37	28	22	18.2	15.6	13.6	11.0	9.2	
	20	42	32	25	21	18.0	15.8	12.6	10.5	
	25	47	35	28	23	20	17.6	14.1	11.7	
	30	52	39	31	26	22	19.3	15.4	12.9	
	40	60	45	36	30	25	22	17.8	14.9	
	50	67	50	40	33	28	25	19.9	16.6	
	60	74	55	44	36	31	27	22	18.2	
	15	49	36	29	24	21	18.2	14.6	12.2	
8006 ② XR8006VS ②	20	57	42	34	28	24	21	16.8	14.0	
	25	63	47	38	31	27	23	18.8	15.7	
	30	69	52	41	34	29	26	21		

# Turbo TeeJet Induction

# TeeJet® Twin Flat Spray Tips

TTI110\_\_VP SPRAY TIP  
(Cross Section View)

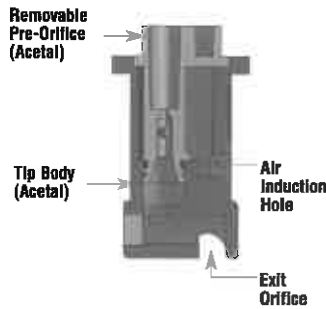

- All acetal construction for excellent chemical and wear resistance
- Compact size to prevent tip damage
- Removable pre-orifice for fast and easy cleaning
- Large, round passages to minimize plugging
- Tapered flat spray pattern
- Patented orifice design
- Large droplets are produced through a venturi air aspirator resulting in less drift
- Wide operating pressure range of 15-100 PSI
- Fits into 09692 cap assembly

## Turbo TwinJet® TTJ60



- Using patented technology from the Turbo TeeJet nozzle there are two, 110° flat spray patterns
- Droplet size range is slightly larger than for the same capacity Turbo TeeJet nozzle providing drift reducing properties with increased canopy coverage and penetration
- Molded Acetal for better chemical and wear resistance in six VisiFlo® color coded capacities (02 through 10) with pressure ranges from 15 - 90 PSI
- Fits into 09692 cap assembly.

	PSI	CAPACITY (1) NOZZLE IN GPM	Gallons per acre (20" nozzle spacing)						
			5 mph	6 mph	8 mph	10 mph	12 mph	15 mph	
	15	0.12	7.1	5.9	4.5	3.6	3.0	2.4	
	20	0.14	8.3	6.9	5.2	4.2	3.5	2.8	
	30	0.17	10.1	8.4	6.3	5.0	4.2	3.4	
	40	0.20	11.9	9.9	7.4	5.9	5.0	4.0	
	50	0.22	13.1	10.9	8.2	6.5	5.4	4.4	
	60	0.24	14.3	11.9	8.9	7.1	5.9	4.8	
	70	0.26	15.4	12.9	9.7	7.7	6.4	5.1	
	100	0.32	19.0	15.8	11.9	9.5	7.9	6.3	
	15	0.15	8.9	7.4	5.6	4.5	3.7	3.0	
	20	0.18	10.7	8.9	6.7	5.3	4.5	3.6	
	30	0.22	13.1	10.9	8.2	6.5	5.4	4.4	
	40	0.25	14.9	12.4	9.3	7.4	6.2	5.0	
	50	0.28	16.6	13.9	10.4	8.3	6.9	5.5	
	60	0.31	18.4	15.3	11.5	9.2	7.7	6.1	
	70	0.33	19.6	16.3	12.3	9.8	8.2	6.5	
	100	0.40	24	19.8	14.9	11.9	9.9	7.9	
	15	0.18	10.7	8.9	6.7	5.3	4.5	3.6	
	20	0.21	12.5	10.4	7.8	6.2	5.2	4.2	
	30	0.26	15.4	12.9	9.7	7.7	6.4	5.1	
	40	0.30	17.8	14.9	11.1	8.9	7.4	5.9	
	50	0.34	20	16.8	12.6	10.1	8.4	6.7	
	60	0.37	22	18.3	13.7	11.0	9.2	7.3	
	70	0.40	24	19.8	14.9	11.9	9.9	7.9	
	100	0.45	27	22	16.7	13.4	11.1	8.9	
	15	0.24	14.3	11.9	8.9	7.1	5.9	4.8	
	20	0.28	16.6	13.9	10.4	8.3	6.9	5.5	
	30	0.35	21	17.3	13.0	10.4	8.7	6.9	
	40	0.40	24	19.8	14.9	11.9	9.9	7.9	
	50	0.45	27	22	16.7	13.4	11.1	8.9	
	60	0.49	29	24	18.2	14.6	12.1	9.7	
	70	0.53	31	26	19.7	15.7	13.1	10.5	
	100	0.63	37	31	23	18.7	15.6	12.5	
	15	0.31	18.4	15.3	11.5	9.2	7.7	6.1	
	20	0.35	21	17.3	13.0	10.4	8.7	6.9	
	30	0.43	26	21	16.0	12.8	10.6	8.5	
	40	0.50	30	25	18.6	14.9	12.4	9.9	
	50	0.56	33	28	21	16.6	13.9	11.1	
	60	0.61	36	30	23	18.1	15.1	12.1	
	70	0.66	39	33	25	19.6	16.3	13.1	
	100	0.79	47	39	29	22	18.6	14.9	

	PSI	CAPACITY (1) NOZZLE IN GPM	Gallons per acre (20" nozzle spacing)						
			5 mph	6 mph	8 mph	10 mph	12 mph	15 mph	
	15	0.12	7.1	5.9	4.5	3.6	3.0	2.4	
	20	0.14	8.3	6.9	5.2	4.2	3.5	2.8	
	30	0.17	10.1	8.4	6.3	5.0	4.2	3.4	
	40	0.20	11.9	9.9	7.4	5.9	5.0	4.0	
	50	0.22	13.1	10.9	8.2	6.5	5.4	4.4	
	60	0.24	14.3	11.9	8.9	7.1	5.9	4.8	
	75	0.27	16.0	13.4	10.0	8.0	6.7	5.3	
	90	0.30	17.8	14.9	11.1	8.9	7.4	5.9	
	15	0.15	8.9	7.4	5.6	4.5	3.7	3.0	
	20	0.18	10.7	8.9	6.7	5.3	4.5	3.6	
	30	0.22	13.1	10.9	8.2	6.5	5.4	4.4	
	40	0.25	14.9	12.4	9.3	7.4	6.2	5.0	
	50	0.28	16.6	13.9	10.4	8.3	6.9	5.5	
	60	0.31	18.4	15.3	11.5	9.2	7.7	6.1	
	75	0.34	20	16.8	12.6	10.1	8.4	6.7	
	90	0.38	23	18.8	14.1	11.3	9.4	7.5	
	15	0.18	10.7	8.9	6.7	5.3	4.5	3.6	
	20	0.21	12.5	10.4	7.8	6.2	5.2	4.2	
	30	0.26	15.4	12.9	9.7	7.7	6.4	5.1	
	40	0.30	17.8	14.9	11.1	8.9	7.4	5.9	
	50	0.34	20	16.8	12.6	10.1	8.4	6.7	
	60	0.37	22	18.3	13.7	11.0	9.2	7.3	
	75	0.41	24	20	15.2	12.2	10.1	8.1	
	90	0.45	27	22	16.7	13.4	11.1	8.9	
	15	0.24	14.3	11.9	8.9	7.1	5.9	4.8	
	20	0.28	16.6	13.9	10.4	8.3	6.9	5.5	
	30	0.35	21	17.3	13.0	10.4	8.7	6.9	
	40	0.40	24	19.8	14.9	11.9	9.9	7.9	
	50	0.45	27	22	16.7	13.4	11.1	8.9	
	60	0.49	29	24	18.2	14.6	12.1	9.7	
	75	0.55	33	27	20	16.3	13.6	10.9	
	90	0.60	36	30	22	17.8	14.9	11.9	
	15	0.31	18.4	15.3	11.5	9.2	7.7	6.1	
	20	0.35	21	17.3	13.0	10.4	8.7	6.9	
	30	0.43	26	21	16.0	12.8	10.6	8.5	
	40	0.50	30	25	18.6	14.9	12.4	9.9	
	50	0.56	33	28	21	16.6	13.9	11.1	
	60	0.61	36	30	23	18.1	15.1	12.1	
	75	0.68	40	34	25	20	16.8	13.5	
	90	0.75	45	37	28	22	18.6	14.9	
	15	0.37	22	18.3	13.7	11.0	9.2	7.3	
	20	0.42	25	21	15.6	12.5	10.4	8.3	
	30	0.52	31	26	19.3	15.4	12.9	10.3	
	40	0.60	36	30	22	17.8	14.9	11.9	
	50	0.67	40	33	25	19.9	16.6	13.3	
	60	0.73	43	36	27	22	18.1	14.5	
	75	0.82	49	41	30	24	20	16.2	
	90	0.90	53	45	33	27	22	17.8	
	15	0.49	29	24	18.2	14.6	12.1	9.7	
	20	0.57	34	28	21	16.9	14.1	11.3	
	30	0.69	41	34	26	20	17.1	13.7	
	40	0.80	48	40	30	24	19.8	15.8	
	50	0.89	53	44	33	26	22	17.6	
	60	0.98	58	49	36	29	24	19.4	
	75	1.10	65	54	41	33	27	22	
	90	1.20	71	59	45	36	30	24	
	15	0.61	36	30	23	18.1	15.1	12.1	
	20	0.71	42	35	26	21	17.6	14.1	
	30	0.87	52	43	32	26	22	17.2	
	40	1.00	59	50	37	30	25	19.8	
	50	1.12	67	55	42	33	28	22	
	60	1.22	72	60	45	36	30	24	
	75	1.37	81	68	51	41	34	27	
	90	1.50	89	74	56	45	37	30	



# Spray Tips

## BoomJet® Boomless Nozzles with Extra wide Flat Spray Projection

Components

The 5880 BoomJet® Nozzle combines two off-center tips and three VeeJet nozzles to produce an overall wide swath flat spray. Nozzle assembly provides a good distribution for the wide pattern coverage obtained. Supplied with one additional 1/4" NPT pipe plug and one blank tip for setting BoomJet® to spray to one side only. Type 5880 also has a 1/4" NPT pressure gauge port. 3/4" NPT inlet.



W = Maximum effective coverage with nozzle mounted at 36" height.



HAMILTON

Product Number	OC Tips (Type)	VeeJet Top Nozzle (Type)	Water Filter (Type)	Liquid Pressure (psi)	Total Capacity (GPM)	W in feet	Gallons Per Acre				
							4 mesh	5 mesh	7.5 mesh	10 mesh	15 mesh
5880 3/4 2TOC06 \$305.93	#8733-0C06	H1/4VV-1506	H1/4VVL-9502 with 50 mesh strainer	20	1.84	33.5	6.8	5.4	3.6	2.7	1.8
				30	2.25	34.0	8.2	6.6	4.4	3.3	2.2
				40	2.60	34.5	9.3	7.5	5.0	3.7	2.5
5880 3/4 2TOC10 \$305.93	OC10	H1/4U-0508HE	H1/4VVL-11004 with 50 mesh strainer	20	2.83	39.5	8.9	7.1	4.7	3.5	2.4
				30	3.46	40.0	10.7	8.6	5.7	4.3	2.9
				40	4.00	40.5	12.2	9.8	6.5	4.9	3.3
5880 3/4 2TOC20 \$342.25	OC20	H1/4U-0520HE	H1/4VVL-9506 with 50 mesh strainer	20	6.08	47.0	16.0	12.8	8.5	6.4	4.3
				30	7.45	50.0	18.4	14.8	9.8	7.4	4.9
				40	8.60	52.0	20.0	16.4	10.9	8.2	5.5
5880 3/4 2TOC40 \$342.25	OC40	H1/4U-0540HE	H1/4U-9510	20	12.0	56.0	27.0	21.0	14.1	10.6	7.1
				30	14.7	60.0	30.0	24.0	16.2	12.1	8.1
				40	17.0	63.0	33.0	27.0	17.8	13.4	8.9

## TeeJet®

### METERING ORIFICES

**Note:** Always insert orifice plate with side marked with number facing the outlet.

**MATERIAL:** Stainless Steel

Chart is based on water with flow regulator on 30" row spacing.



Orifice No.	Pressure in PSI	Capacity In GPM	Gallons Per Acre				
			3 MPH	4 MPH	5 MPH	6 MPH	8 MPH
4916 65 \$3.88	10	261	17.2	12.8	10.2	8.5	6.4
	20	369	24.4	17.8	14.5	12.1	9.0
	30	452	29.7	22.4	17.8	14.5	11.1
	40	522	34.3	25.6	20.5	17.0	12.8
4916 70 \$3.88	10	306	19.8	15.2	12.0	10.0	7.5
	20	432	28.4	21.1	17.2	13.9	10.6
	30	530	34.3	25.7	20.5	17.2	13.0
	40	612	39.6	30.4	24.0	19.9	15.0
4916 75 \$3.88	10	347	22.4	17.2	13.9	11.4	8.5
	20	491	32.3	23.8	19.1	15.8	12.0
	30	601	39.6	29.7	23.8	19.8	14.5
	40	694	44.9	34.3	27.7	22.7	17.0
4916 80 \$3.88	10	396	25.7	19.1	15.8	12.9	9.7
	20	561	37.0	27.7	21.8	18.5	13.9
	30	687	44.9	33.7	27.1	22.4	16.5
	40	792	51.5	38.3	31.7	25.9	19.4
4916 89 \$3.88	10	490	26.4	23.8	19.1	15.8	12.0
	20	693	45.5	33.7	27.1	22.4	17.2
	30	849	55.4	41.6	33.0	27.7	21.1
	40	980	64.7	47.5	38.3	31.7	24.0
4916 95 \$3.77	10	572	37.6	27.7	22.4	18.5	13.9
	20	808	52.8	39.6	31.7	26.4	19.8
	30	990	64.7	48.8	36.9	32.3	24.4
	40	1,144	75.2	55.4	44.9	37.0	27.7
4916 107 \$3.88	10	735	48.2	36.3	29.0	23.8	17.8
	20	1,04	68.0	50.8	40.9	33.7	25.7
	30	1,27	83.2	62.7	50.2	41.6	31.0
	40	1,47	96.4	72.6	58.1	47.5	35.6



**FC-XT010** (Yellow)  
**FC-XT020** (Blue)

\$88.82  
\$60.69

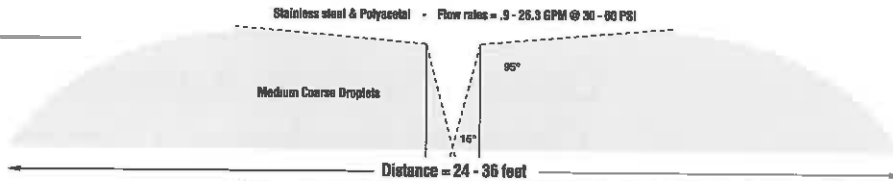

X Tender Boom Nozzles for Broadcast Applications					
Tip #	psi	gpm	Application Rate GPA		
			4 mph	5 mph	6 mph
XT010	30	0.9	7	5.6	4.6
	40	1.0	7.7	6.2	5.2
	50	1.1	8.5	6.8	5.7
	60	1.2	9.3	7.4	6.2
XT020	30	1.7	12.4	9.9	8.3
	40	2.0	14.6	11.6	9.7
	50	2.2	16.0	12.8	10.7
	60	2.4	17.5	14.0	11.6

\*All swaths and flow rates are based on tests conducted at 40 psi with nozzles parallel to the ground and 48-inches high while stationary. Changes in spray height, operating pressure, mounting angle, and application speed will influence swath width.

**STRAINERS**



**STRAINER**

Strainer is three part assembly consisting of body, cap and screen. Stainless steel screens in 50 and 100 mesh size.

TeeJet® Strainer No.	Strainer Body & Cap Material	Mesh Screen Material
8079NY	Polypropylene	Stainless Steel - 50
8079NY100	Polypropylene	Stainless Steel - 100

**STRAINER & BALL CHECK**

Prevents nozzle dripping, fits all TeeJet® nozzles. Ball check opens at 5 PSI. Recommended for flow rates up to 0.8 GPM 50 and 100 mesh screens.

Check Valve No.	Body and Cap Screw Material	Mesh Screen Material
4193APP50	Polypropylene	Stainless Steel
4193APP100	Polypropylene	Stainless Steel

**Spray Tip Technical Information**

**Useful Formulas**

$$\text{GPM (Per Nozzle)} = \frac{\text{GPA} \times \text{MPH} \times \text{W}}{5,940}$$

$$\text{GPA} = \frac{5,940 \times \text{GPM (Per Nozzle)}}{\text{MPH} \times \text{W}}$$

GPM — Gallons Per Minute

GPA — Gallons Per Acre

mph — Miles Per Hour

W — Nozzle spacing (in inches) for broadcast spraying  
— Spray width (in inches) for single nozzle, band spraying or boomless spraying.

Row spacing (in inches) divided by the number of nozzles per row for directed spraying.

**Measuring Travel Speed**

Measure a test course in the area to be sprayed or in an area with similar surface conditions. Minimum lengths of 100 and 200 feet are recommended for measuring speeds up to 5 and 10 mph respectively. Determine the time required to travel the test course. To help ensure accuracy, conduct the speed check with a loaded sprayer and select the engine throttle setting and gear that will be used when spraying. Repeat the above process and average the times that were measured. Use the following equation or the table below to determine ground speed.

$$\text{Speed (mph)} = \frac{\text{Distance (ft)} \times 60}{\text{Time (seconds)} \times 88}$$

Weight of solution	Specific Gravity	Conversion Factor
7.0 lbs. per gallon	.84	.92
8.0 lbs. per gallon	.96	.98
8.34 lbs. per gallon — WATER	1.00	1.00
9.0 lbs. per gallon	1.08	1.04
10.0 lbs. per gallon	1.20	1.10
10.65 lbs. per gallon — 28% Nitrogen	1.28	1.13
11.0 lbs. per gallon	1.32	1.15
12.0 lbs. per gallon	1.44	1.20
14.0 lbs. per gallon	1.68	1.30

**Tractor Speeds**

Speed in mph (Miles Per Hour)	Time Required in SECONDS to Travel a Distance of:		
	100 Feet	200 Feet	300 Feet
3.0	23	45	68
3.5	20	39	58
4.0	17	34	51
4.5	15	30	45
5.0	14	27	41
6.0	—	23	34
7.0	—	19	29
7.5	—	18	27
8.0	—	17	26
9.0	—	15	23

**Tips Don't Last Forever!**

There is sufficient evidence that spray tips may be the most neglected component in today's farming...yet they are among the most critical of items in proper application of valuable agricultural chemicals.

For example, a 10 percent overapplication of chemical on a twice-sprayed 1000-acre farm could represent a loss of \$2,000-\$10,000 based on today's chemical investments of \$10.00-\$50.00 per acre. This does not take into account potential crop damage.

# Dethmers Manufacturing Company Demco Products Agricultural Equipment Original Purchaser's Limited Warranty

## 1. Extent and Duration of this Warranty:

Subject to paragraphs 2 through 8 of this warranty, your Demco Agricultural Equipment is warranted to be free from defects in materials and workmanship under normal use and service for a period of 1 year after date of purchase by the original (first) retail owner, or until it is resold or transferred by you, the original owner. Tires and lights are not included in this warranty.

Tires are warranted by the manufacturer against defects in materials and workmanship but not against road hazards.

## 2. Manufacturer and Warrantor of Equipment (Excluding tires and lights):

Dethmers Manufacturing Co.  
4010 320th St.  
Boyden, IA 51234  
(712) 725-2311

The manufacturer and warrantor of the tires has molded its name permanently into the tires. Tire warranty questions and claims can be taken directly to an authorized dealer of the tire manufacturer.

## 3. Repair or Replacement Procedure:

If your Demco Agricultural Equipment develops a defect (except for tires or lights) during the warranty period, promptly notify Dethmers Manufacturing Co. customer service department. Until such notice is received, Warrantor will not be responsible for any repair or replacement.

Upon receipt of notice from you, Warrantor will in its sole discretion choose one of the following options to satisfy the warranty:

- a) Warrantor may elect to ship a new part to its dealer to be exchanged free of charge for the defective part returned by you to the dealer. Any defective part will be repaired or replaced and returned to you free of charge. Any part returned to Warrantor and found not to be defective will be returned to you freight collect with an explanation; or
- b) Warrantor may elect to ship a new part to its dealer to be exchanged free of charge for the defective part returned by you to the dealer; or
- c) Warrantor may elect to ship or deliver a replacement part to your address.

## 4. Limitations on Warranty Coverage:

Coverage under this warranty will be effective only when a copy of the original invoice, showing the date and location of purchase, accompanies any claim for warranty.

Warrantor has no liability whatsoever and this warranty is null and void if any Demco Agricultural Equipment has been subjected to neglect, negligence, misuse, accident or operated in any way contrary to the operating and maintenance instructions as specified in the Demco Owner's Manual for that model. This warranty does not cover any Agricultural Equipment that has been altered or modified so as to affect adversely the Agricultural Equipment's operation, performance or durability, or that has been altered or modified to change the intended use of the Agricultural Equipment.

In addition, the warranty does not extend to repairs made necessary by normal use or by the use of parts, accessories or

other equipment which in the sole judgment of Warrantor, are either incompatible with the Demco Agricultural Equipment, or adversely affect its operation, performance or durability. This warranty does not cover:

- 1) Normal wear and tear
- 2) Road film or gravel damage to paint
- 3) Paint
- 4) Rust damage
- 5) Any Demco Agricultural Equipment that has been loaded in excess of the load capacity stated on the Agricultural Equipment identification label.

Warrantor has a policy of continuous product improvement. We reserve the right to change or improve the design of any Demco Agricultural Equipment model without assuming any obligation to modify any Agricultural Equipment previously manufactured.

## 5. Exclusion of Implied Warranties:

The only warranty provided for this product is the limited warranty contained in paragraph 1 above. All implied warranties are expressly excluded, including, but not limited to, implied warranties of merchantability, implied warranties of fitness for a particular purpose, and any implied warranties arising from course of dealing or usage of trade. There are no warranties that extend beyond the description on the face of this warranty.

Some states do not allow limitations on implied warranties and this limitation may not apply to you.

## 6. Limitation on Consequential Damages:

Warrantor's responsibility under this warranty extends only to repair or replacement of your Demco Agricultural Equipment and its component parts. Warrantor does not assume responsibility for, nor shall be liable for, any special, incidental or consequential damages.

Warrantor assumes no responsibility to the owner for loss of use of the Agricultural Equipment, loss of time, inconvenience or other damage consequential or otherwise, including, but not limited to, loss of income or revenue, additional operating expenses, expense for gasoline, expense of transporting the Agricultural Equipment to the dealer and expense of returning the Agricultural Equipment, travel time, telephone or telegram charges, road service/towing charges, rental of another Agricultural Equipment during the time warranty repairs are being performed, travel, lodging, loss or damage to personal property.

Some states do not allow the exclusion or limitation of incidental or consequential damages, so the above exclusion or limitation may not apply to you.

## 7. Purchaser's Rights:

This warranty gives you specific legal rights, and you may also have other rights which vary from state to state.

## 8. Exclusive Warranty:

This is the only express warranty made by Dethmers Manufacturing Co. on your Demco Agricultural Equipment and no person other than a corporate officer of Demco is allowed to change or add to this warranty.

# 750 WAGON



# 1050 GRAIN CART





# Demco

## *We've been time tested and proven...*

Back in 1950, Robert Dethmers started Dethmers Manufacturing Company in a corner of an implement dealership. One of his first products was fertilizer application equipment for the agricultural industry.

Today, as Demco continues to grow, our tradition of building quality products, employing talented, industrious people and providing attentive service remains. Our sales staff along with our dealers and distributors across the United States, Canada and the world carry on the standard.

Meeting the challenges and opportunities of changing times has produced growth in product lines. Our products are engineered and constructed with the best of materials and the latest in manufacturing technology, then tested beyond recommendations, pushing the product to its limit before the Demco name goes on. Our reputation was built on quality and dependability and we continue by being tougher on the product than the consumer.

Demco is committed to give its customers quality products tailored to meet their needs.

**Demco** / **MAURER  
MANUFACTURING**

*Affiliated since 2000*

Doing our Best to Provide You the Best

# Land Pride

## Product Guide

3P606NT

Page 107



**Lp** Consistently Leading the Way...



**MOWERS**

All-Flex Mowers ..... 6  
 Flail Mowers..... 9  
 Grooming Mowers ..... 3  
 Zero Turn Mowers..... 12

**CUTTERS..... 15**

**TILLERS..... 41**

**SEEDERS**

All-Purpose Seeders ..... 47  
 Fertilizer Spreaders ..... 52  
 Food Plot Seeders ..... 50  
 Primary Seeders ..... 49  
 Overseeders ..... 48  
 Seed Bed Rollers..... 51

**DIRTWORKING**

Box Scrapers ..... 60  
 Core Aerators ..... 64  
 Disc Harrows..... 66  
 Ditchers..... 68  
 Drag Harrows..... 51  
 Drag Scrapers..... 70  
 Grading Scrapers ..... 71  
 Hydraulic Reservoir Systems ..... 72  
 Landscape Rakes..... 73  
 Pallet Forks ..... 92  
 Pasture Aerators..... 76  
 Post Hole Diggers..... 77  
 Powered Rakes..... 80  
 Quick-Hitches ..... 81  
 Rear Blades ..... 54  
 Scarifiers..... 75  
 Soil Pulverizers ..... 82  
 Spike Tooth Harrows ..... 83  
 Straw Crimper..... 65  
 Wood Chippers..... 84

**GRAPPLES..... 85**

**SKID STEER**

Angle Brooms ..... 90  
 Bale Spears ..... 91  
 Pallet Forks ..... 92  
 Post Hole Digger..... 93  
 Powered Rakes..... 94  
 Quick-Hitch ..... 96  
 Rotary Cutters..... 95  
 Skid Tillers ..... 98  
 Stump Grinder ..... 97  
 Tree/Post Puller ..... 99  
 Trip Edge Snow Blades ..... 100

**SNOW TOOLS**

Snow Blowers ..... 101  
 Snow Pushers ..... 104

**COMPACT DRILLS ..... 105**

# Product Guide

## Quality products from Land Pride.

Land Pride, A Division of Great Plains Mfg., Inc., has been a leader in grounds maintenance equipment throughout North America since 1986. Today Land Pride is a leading U.S. manufacturer of tractor mounted and skid-steer mounted implements including Rotary Tillers, Grooming Mowers, Seeders, Rotary Cutters, Rear Blades, Landscape Rakes, Post Hole Diggers, and Grapples.

At Land Pride, we have earned the reputation of standing behind our products. We know how important it is for you to feel confident in purchasing products that are reliable, and to know that our support is available when assistance is needed.

Many products are available in colors to match your tractor. See the legend next to the model throughout this catalog for color availability.

**Color Options:**



Land Pride Quick-Hitch Systems, available in a Tractor Mount Cat. 1 Sub-Compact, Cat. 1 and Cat. 2 Tractor 3-Point Hitch or Skid Steer Mount Cat. 1 or 2 non-PTO Steer Hitch, fit most

Land Pride products and are a real time saver when working on multiple projects. Look for the Quick-Hitch System icon to denote applicable products.



Models may or may not include options. Design and specifications subject to change without notice. See dealer for complete warranty information.





## Designed for the homeowner.

Designed and built with homeowners in mind, the FDR16 is just right for subcompact and compact tractors. With our tapered rear discharge area, foreign objects are discharged closer to the ground, plus you can mow close to objects with either side of the mower. The floating lower clevises allow the mower to cut evenly over uneven terrain.



The driveline storage hook keeps the driveline off the ground when not in use.



	FDR1648	FDR1666	FDR1672
Horsepower	15-30 HP		
Hitch	Cat. 1		
Working Width (cm)	48" (122)	60" (152)	72" (183)
Overall Width (cm)	51" (130)	63" (160)	75" (190)
Weight - lb (kg)	486 (220)	577 (262)	619 (281)
Mowing Height	3/4" - 3-1/4"	3/4" - 5-1/4"	
Deck Material Thickness	3/16"		
Blades 3 ea. Heat Treated Alloy Steel	1/4" x 2-1/2" x 16-7/8"	1/4" x 2-1/2" x 21"	1/4" x 2-1/2" x 25"
Blade Overlap	1-1/4"		
Blade Spindles	Greaseable		
Blade Tip Speed	16,203 FPM	18,195 FPM	18,130 FPM
Castered Gauge Wheels, 4-each	3-1/4" x 10" Solid Rubber Tire		
Castered Wheel Spindle	1" Diameter Stressproof® Material		
Drive Train	540 RPM B-Section V-Belt		
Driveline	Heavy-duty w/Quick Coupler		
Front Roller	Optional		

See dealer for complete warranty information.

Color Options:



60" & 72" Only

- Two position top hitch allows for various tractor lift capabilities
- Floating 3-point for ground following capabilities
- 1" Stressproof® wheel spindles with nylon bushings for smooth casting
- Single B-section belt with Kevlar®
- Grease bearings from top without removing belt covers
- Optional mulching blades available

Stressproof® is a Registered Trademark of Niagara Lasalle Corporation  
Kevlar® is a Registered Trademark of DuPont™



## Built for tough jobs and long days.

Discharging grass out the rear of the mower leaves a clean cut. The FDR25 distributes grass evenly over a wide surface, and it doesn't discharge into unwanted areas.



	FDR2572	FDR2584
<b>Horsepower</b>	15-50 HP	
<b>Hitch</b>	Cat. 1	
<b>Working Width (cm)</b>	72" (183)	84" (213)
<b>Overall Width (cm)</b>	74-7/8" (190)	86-1/2" (220)
<b>Weight - lb (kg)</b>	718 (326)	812 (368)
<b>Mowing Height</b>	3/4" - 5-1/4"	
<b>Discharge</b>	Rear	
<b>Lower Hitch</b>	Floating Clevis w/Plated Pins	
<b>Top Link</b>	Floating Clevis	
<b>Deck Material Thickness</b>	3/16"	
<b>Blades 3 ea. Heat Treated Alloy Steel</b>	1/4" x 2-1/2" x 25"	5/16" x 2-1/2" x 29"
<b>Blade Overlap</b>	1-1/4"	
<b>Blade Spindles</b>	Greaseable	
<b>Deck Spindle Housings</b>	Cast Iron Greaseable Hubs	
<b>Blade Tip Speed</b>	13,130 FPM	17,210 FPM
<b>Caster Gauge Wheels, 4-each</b>	6-1/4" x 10" Solid Rubber Tire	4" x 11" Semi-solid Tire
<b>Caster Wheel Spindle</b>	1" Diameter Stressproof® Material	
<b>Drive Train</b>	540 RPM B-Section V-Belt	
<b>Drive Line</b>	Heavy-duty w/Quick Coupler	
<b>Front Roller</b>	Optional	

See dealer for complete warranty information.

Color Options:



Solid rubber tires on 72 model are sandwiched between the rim halves and bolted in.



Main drive cast iron pulley offers superior strength and belt slippage control.

Some tractor and tire combinations do not allow enough room for mower hook-up. Longer lower hitch clevises are available to easily correct this situation.



Blade spindles and bearings are precision fit in a cast iron housing.



- Lower hitch clevises adjust in and out for greater leverage
- Floating 3-point for superior ground hugging capabilities
- 1" Stressproof® wheel spindles with nylon bushings for smooth casting
- Single B-section Kevlar® belt, spring-loaded for maximum performance
- Rounded front corner without lip helps protect trees and fences
- Grease bearings from top without removing belt covers

# FDR36 GROOMING MOWER

HP  
30-60

HITCH  
Cat. 1

## Designed for heavy commercial use.

Our FDR3690 Rear Discharge Grooming Mower is pure muscle! Its 90" width can swallow a lot of grass in one bite. The rear discharge area directs debris toward the ground and the free-swinging blades rotate at 16,500 fpm. The tapered deck allows users to get close to trees or other obstacles and the medium lift blade produce a finely groomed lawn every time.



The FDR36 frame-over-deck design is engineered for maximum airflow, featuring a roll-formed 1/4" leading edge, 6 free-swinging blades and a tapered and sloped rear deflector.

	FDR3690
Horsepower	30-60 HP
Hitch	Cat. 1
Working Width	90" (229)
Overall Width (cm)	92" (234)
Weight - lb (kg)	930 (422) (w/o Front Roller)
Mowing Height	1" - 6-1/2" in 1/4" Increments w/Plated Spacers
Discharge	Rear
Lower Hitch	Floating Clevis w/Plated Pins
Top Link	Floating Clevis
Deck Material Thickness	3/16"
Blades 6 ea.	Free Swinging, 1/4" x 2-1/2" x 14" Hardened, Medium Lift (2 per blade spindle)
Blade Overlap	2"
Blade Tip Speed	16,500 FPM
Blade Spindles	1-3/8" Stressproof® Shaft
Deck Spindle Housings	Cast Iron Greasable Hubs
Drive Train	540 rpm Double V Powerband Belt
Belt Take-up	Spring Loader Idler
Gearbox	540 rpm, Cast Iron Housing with Beveled Gears
Caster Gauge Wheels	5" x 13" Semi-Solid Tire with Bearings
Caster Wheel Spindle	1-1/4" Diameter with Greasable Bushing
Driveline	Heavy-Duty Cat. 4 w/Quick Coupler
Front Roller	Optional

See dealer for complete warranty information.

Color Options:



Quick Hitch

5 YEAR  
Limited Gearbox  
Warranty

- Floating 3-point
- Clevis hitches for easy one person hook-up
- 3/16" Deck material
- 6 Free swinging blades
- 13" Semi-solid tires with bearings
- Spring loaded idler
- Cast iron pulleys
- Grease bearings from top without removing belt covers

Land Pride

MOWERS

## Unmatched Performance.



An 11' AFM is just right to use around the golf course, in the city park, or to maintain your five acre estate. Easy to use and maintain, keep your grass looking like it was cut with a walk-behind, but with a lot less time invested!

- Automatic wing locks for transport
- Zero turning radius due to sleek frame design
- Rear discharge for even dispersal
- Easy to grease from top blade spindles



Dispensing cut grass is a key ingredient to maintaining healthy turf. The more evenly and completely the cut grass is dispersed, the quicker it works its way towards the soil for decomposition.

	AFM4211
Horsepower	30-65 HP
Hitch	Pull-Type, Adjustable Claws & Safety Tow Chain
Working Width (cm)	11'1" (338)
Overall Width	11'3-1/2"
Transport Width	7'8"
Positive Tongue Wt - lb	450
Weight - lb (kg)	2040 (918)
Cutting Height	1" - 5-1/2" in 1/4" incr.
Wing Cylinders	2-1/2" x 12"
Rear Deck Cylinder Gearbox	2" x 8" 540 RPM, 1 Splitter, 3 Wing
Decks, 3 each	48"
Deck Thickness	3/16"
Deck Overlap	8"
Deck Spindle Housing	Cast Iron Greaseable Hubs
Blade Size	1/4" x 2-1/2" x 16-7/8"
Blade Overlap	1-3/16"
Blade Tip Speed	16,020 fpm (182 mph)
Blade Bearings	Greaseable Ball Bearings
Blade Spindles	1-3/8" Stressproof® Shaft
Blade Spindle RPM	3,628 RPM
Drive Train	540 RPM B-section V Belt
Discharge	Rear
Deck Tires - 10 total	13 x 5 Air Tire, Sealant
Deck Wheel Spindles	1-1/4" w/Nylon Bushings
Transport Tires and Bearing	18 x 9.5, Sealant and Tapered Bearings
Anti-Scalp Roller	Front Center and Outside Deck Corners
Input Driveline	Cat. 3 CV
Deck Driveline	Cat. 2 w/ or w/o Slip-Clutch
Mowing capacity @2mph	2.66 Acres/hr
@4mph	5.37 Acres/hr
@6mph	8.1 Acres/hr
Flex-Wings	23° L-R, 22° F-B
Flex Center	13° F-B

See dealer for complete warranty information.

Color Options:



## Get the results you deserve!

The AFM is perfect for golf course maintenance, large estates, city recreation areas and sports fields. Sleek enough to get under trees and agile enough to turn on a dime, the AFM Series is just right for all around maintenance. And the quality of cut is the best feature of all.



- Wings automatically lock for safe transport, release with pull rope or optional hydraulics
- Single B-section belt per deck with spring-loaded belt tensioner
- Rear discharge without chains. Chains collect moist grass and drop it in unsightly clumps
- Wing decks discharge clippings away from the rear deck
- Wing deck rear wheels are non-castering; helps hold mower on slopes
- Single beam hitch and generous deck overlap virtually eliminate skipping in "zero-turn" situations



Anti-scalp rollers on nose and trailing edges of decks protect the deck as well as the turf.



Low deck pivot allows for greater side to side flotation on the wing decks.



Over center release easily takes tension off the drive belts during extended off time, or for belt replacement.



Optional Hydraulic Wing Unlock allows user to unlock the wings from the tractor seat.

	AFM4214	AFM4216
<b>Horsepower</b>	40-70 HP	
<b>Hitch</b>	Pull-Type, Adjustable Clevis & Safety Tow Chain	
<b>Working Width (cm)</b>	14' (427)	16' 8" (508)
<b>Overall Width</b>	14' 3"	16' 10"
<b>Transport Width</b>	6' 8"	8' 10"
<b>Positive Tongue Wt - lb</b>	540	580
<b>Weight - lb (kg) (w/15' tires)</b>	3000 (1361)	3315 (1504)
<b>Cutting Height</b>	3/4" - 5-1/4" in 1/4" incr.	
<b>Wing Cylinders</b>	2-1/2" x 12"	
<b>Rear Deck Cylinder</b>	2-1/2" x 8"	
<b>Gearbox</b>	540 RPM, 3 Wing, 1 Splitter	
<b>Decks: 3 each</b>	60"	72"
<b>Deck Thickness</b>	3/16"	
<b>Deck Overlap</b>	6"	8"
<b>Deck Spindle Housing</b>	Cast Iron Greaseable Hubs	
<b>Blade Size</b>	5/16" x 2-1/2" x 20-29/32"	5/16" x 2-1/2" x 25"
<b>Blade Overlap</b>	1-1/4"	
<b>Blade Tip Speed</b>	18,396 fpm	18,340 fpm
<b>Blade Bearings</b>	Greaseable Ball Bearings	
<b>Blade Spindles</b>	1-3/8" Stressproof® Shaft	
<b>Blade Spindle RPM</b>	3,362 RPM	2,802 RPM
<b>Drive Train</b>	540 RPM B-section V Belt	
<b>Discharge</b>	Rear	
<b>Deck Tires - 10 total</b>	15 x 6.6 Air Tire, Sealant or 18 x 9.5 Air Tire, Sealant	
<b>Deck Wheel Spindles</b>	1-1/4" w/Nylon Bushings	
<b>Transport Tires and Bearing</b>	23 x 10.5, Sealant Tapered Bearings	
<b>Anti-Scalp Roller</b>	Front Center and Outside Deck Corners	
<b>Input Driveline</b>	Cat. 4 CV	
<b>Deck Driveline</b>	Cat. 2 w/ or w/o Slip-Clutch	
<b>Mowing capacity @2mph</b>	3.39 Acres/hr	4.0 Acres/hr
<b>@4mph</b>	6.78 Acres/hr	8.1 Acres/hr
<b>@6mph</b>	10.17 Acres/hr	12.1 Acres/hr
<b>Flex-Wings</b>	23° L-R, 22° F-B	
<b>Flex Center</b>	10° L-R, 22° F-B	

See dealer for complete warranty information.

Color Options: 

**5 YEAR**  
Limited Gearbox  
Warranty

**Land Pride**



## Wide open spaces...

Our 22' All-Flex Mower is ideal for those wide open spaces. Cutting a 22' swath takes a bite out of any workload, while leaving behind a professionally performed finish.



The commercial duty 1-5/8" blade spindle features a cast iron housing, additional steel plate support, a 3/4" thick blade support bar and a remote greasing line.



Transport width of 9'6" allows for safe transport from site to site.

	AFM4522
Horsepower	65-100 HP
Hitch	Pull-Type, Adjustable Clevis & Safety Tow Chain
Working Width (cm)	21' 9" (863)
Overall Width	22'
Transport Width	9' 6"
Positive Tongue Wt - lb	740
Weight - lb (kg)	4150 (1886)
Cutting Height	3/4" - 5-1/4" in 1/4" incr.
Wing Cylinders	3-1/2" x 12"
Rear Deck Cylinder	2-1/2" x 8"
Gearbox	640 RPM, 3 Wing, 1 Splitter
Decks: 3 each	90°
Deck Thickness	3/16"
Deck Overlap	4-1/2"
Blade Hub	6 Bolt Casting
Blade Size	5/16" x 2-1/2" x 31-17/32"
Blade Overlap	2-1/4"
Blade Tip Speed	13,498 fpm
Blade Bearings	Greaseable Ball Bearings
Blade Spindles	1-5/8" Stresspro® Shaft
Blade Spindle RPM	2,241 RPM
Blade Drive Belt	1 C-section
Discharge	Rear
Deck Tires - 10 total	18 x 9.5 Air Tire, Sealant
Deck Wheel Spindles	1-1/4" w/Nylon Bushings
Transport Tires and Bearing	P27560SR Tapered Bearings
Anti-Scalp Roller	Front Center of Each Deck
Input Driveline	Cat. 4 CV
Deck Driveline	Cat. 3 w/Slip-Clutch
Mowing capacity @2mph	5.27 Acres/hr
@4mph	10.54 Acres/hr
@6mph	15.82 Acres/hr
Flex-Wings	23° L-R, 22° F-B
Flex Center	10° L-R, 22° F-B

See dealer for complete warranty information.

Color:



- Anti-scalp rollers on each deck reduces turf damage
- 18" Deck tires with sealant mean fewer pounds per square inch
- Single C-section belt per deck with spring-loaded belt tensioner
- Single beam tongue for zero turning radius
- Rear discharge decks for even dispersal
- Adjustable clevis hitch to fit various draw bar heights

## Fast, clean and dependable mowing.

Land Pride Flail Mowers are the perfect choice for schools and other recreational areas where people may be present. With the rotor working in the opposite direction of travel, the cut grass is brought up and over the rotor. Most clippings are laid down prior to the mower passing by, which means foreign objects also have a tendency to stay inside the mower and are less likely to be discharged.

The 21 Series Flail Mower offers a two position hitch for offsetting the mower, enabling closer cutting along buildings, fences, or roadsides.

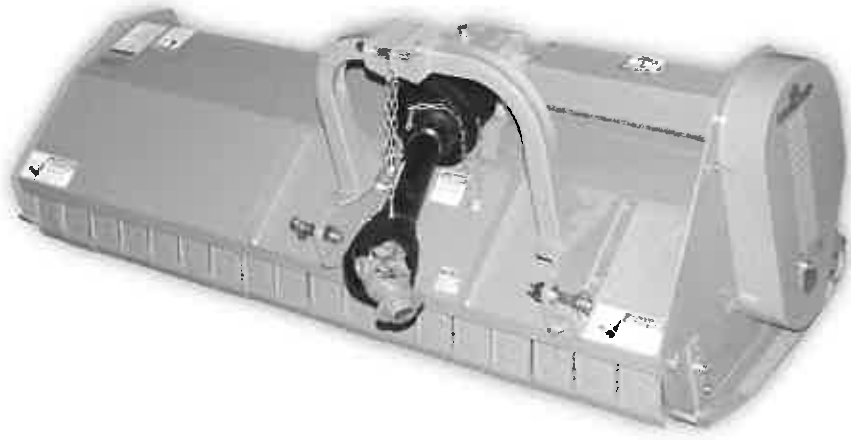

Tapered ends on rear roller prevent gouging during tight turns.

	FM2160	FM2172
Horsepower	25-55 HP	
Hitch	Cat. 1	
Working Width (cm)	60" (152)	72" (183)
Weight - lb (kg)	695 (315)	772 (350)
Cutting Height	3/4" - 4"	
Cutting Capacity	1"	
Offset Hitch	6-1/4" Right, Centered	
Deck Thickness	11 Gauge	
Knives	Duck-foot Type	
Rotor Diameter	5"	
Rotor Rotation	Reverse	
Belt Type	3 'B' Section	
Gearbox RPM	540 w/Over-Running Clutch	
Driveline	Cat. 4	

Color: 

- Rear height adjusting roller with greaseable bearings
- Scraper on rear height adjusting roller
- 2 Position hitch for offsetting, enabling closer cutting along buildings, fences, or roadsides
- Adjustable skid shoes
- Duckfoot style blade for grooming
- Rear door access for ease of changing blades



Free-swinging duckfoot style blade is capable of providing a groomed appearance as well as cutting material up to 1" thick.



## Perfect for schools and recreational areas.

The perfect model for mowing around schools and municipalities, the 31 Series has a mostly enclosed structure to keep the cut grass and other debris within the cutting chamber.

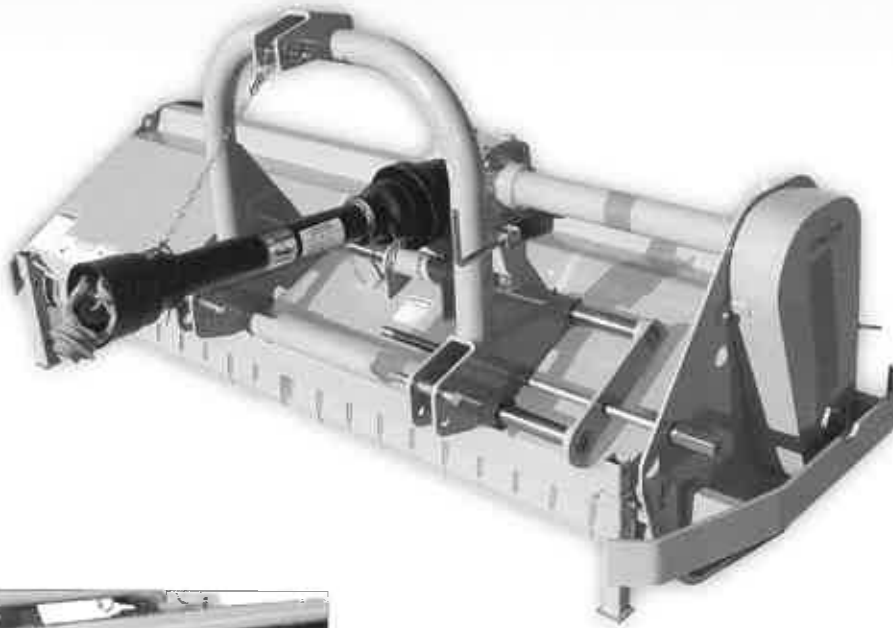

	FM3118
Horsepower	35-80 HP
Hitch	Cat. 1 & 2
Working Width (cm)	88" (224)
Weight - lb (kg)	1,300 (590)
Cutting Height	1/2" - 6"
Cutting Capacity	1"
Offset Hitch	7-3/4" Left & Right, Screw Type
Deck Thickness	3/16"
Knives	Fine Cut
Nc. of Knives	48
Rotor Diameter	5-1/2"
Rotor Rotation	Reverse
Belt Type	3 'B' Section
Gearbox RPM	540 w/Over-Running Clutch
Driveline	Cat. 4

Color: 

- Rear height adjusting roller with greaseable bearings and tapered ends to prevent gouging during turns
- Scraper on rear height adjusting roller
- Fenders on both ends to protect trees
- Gearbox with built-in over-running clutch allows rotor to free-wheel to a stop
- Easy to adjust screw-type offset hitch

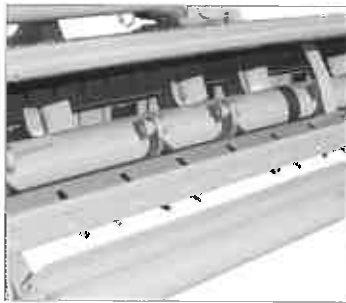

The two blade system results in a fine cut.

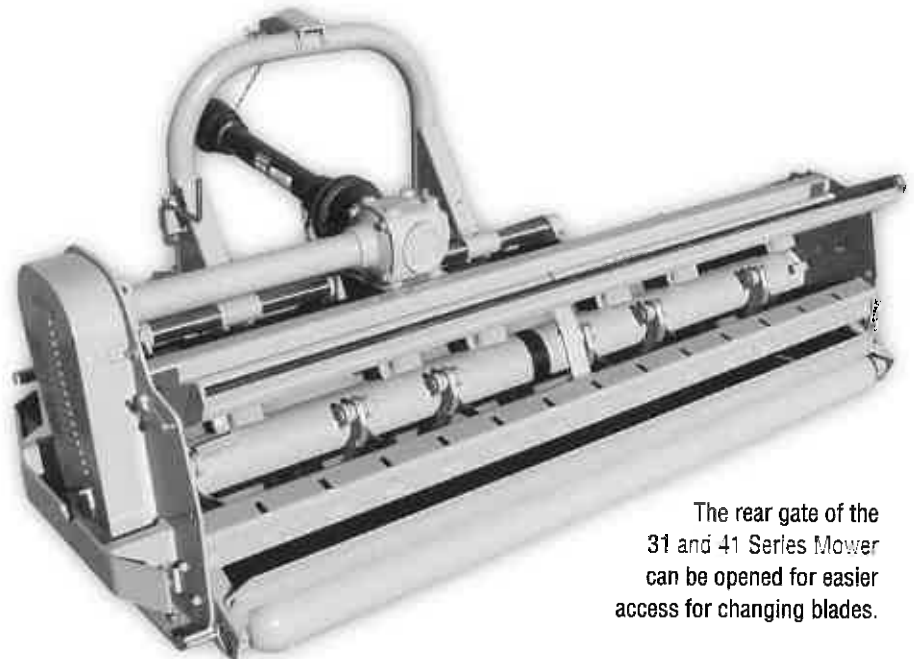

The rear gate of the 31 and 41 Series Mower can be opened for easier access for changing blades.

## Tough machine offering fine results.

The 41 Series offers 3/16" deck material and utilizes a threaded rod to easily offset the hitch by nearly 8". The gearbox incorporates an over-running clutch that enables the rotor to swing free to a stop when the tractor PTO has been turned off. The 41 Series also offers cast and machined hammers and brush rake teeth.

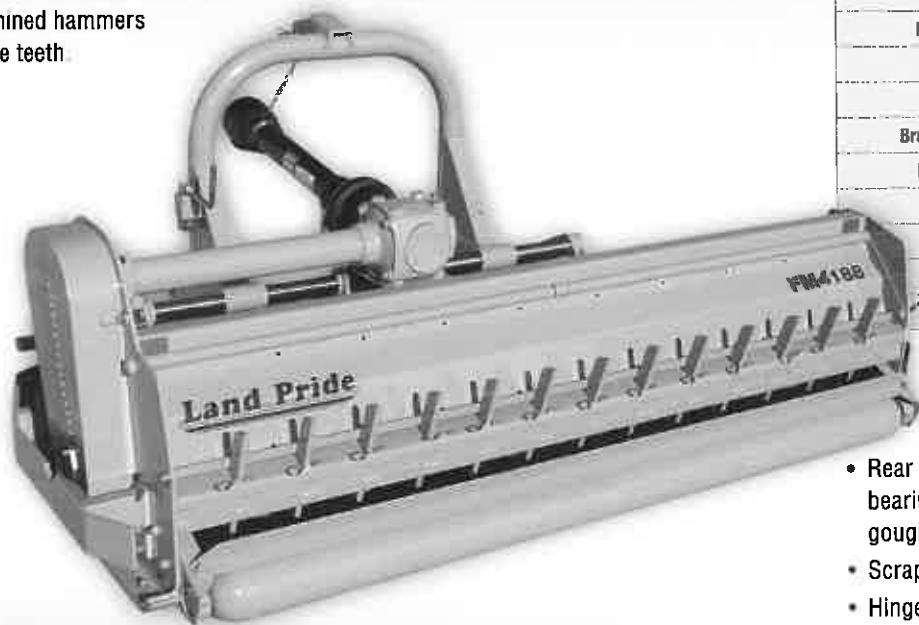

	FM4188
Horsepower	35-80 HP
Hitch	Cat. 1 & 2
Working Width (cm)	88" (224)
Weight - lb (kg)	1,323 (600)
Cutting Height	1/2" - 6"
Cutting Capacity	2"
Offset Hitch	7-3/4" Left & Right, Screw Type
Deck Thickness	3/16"
Knives	Hammers
No. of Knives	24
Brush Rake Teeth	13 Each
Rotor Diameter	5-1/2"
Rotor Rotation	Reverse
Belt Type	3 'B' Section
Gearbox RPM	540 w/Over-Running Clutch
Driveline	Cat 4

Color:

- Rear height adjusting roller with greaseable bearings and tapered ends to prevent gouging during turns
- Scraper on rear height adjusting roller
- Hinged rear gate allows opening for easy access to hammers
- Fenders on both ends to protect trees
- Gearbox with built-in over-running clutch allows rotor to free-wheel to a stop
- 13 Adjustable brush rake teeth keep prunings in the blade path for maximum mulching

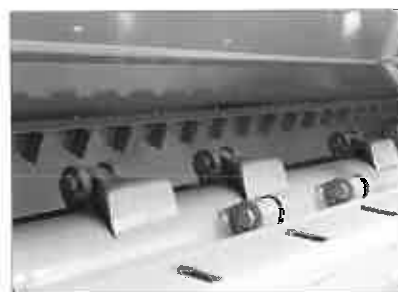

The baffles on the top inside of the deck keep the cut material from clumping together.

The 41 Series features 24 cast and machined hammers to shred prunings and to provide a nice clean cut in grass.



## Perfect Cut...

The ZST is just the right size with features that treat a homeowner to durability, efficiency, and a great manicured lawn!



The ZST Series residential class mowers are compact in size and ideal for homeowner grass maintenance.



Adjustable seat and steering levers allow for various positions to meet varying size requirements.

	ZST40	ZST48
Cutting Width	40"	48"
Cutting Height	1" to 4-1/2" in 1/2" increments	
Engine	16 HP Kawasaki	18 HP Kawasaki
Deck Thickness	11 Gauge w/11 ga. Doubler Plate	
Steering	Twin Lever	
Anti-Scalp Rollers	1	2
Blades	Heat Treated, Medium Lift, Fusion® edge 2 on 40", 3 on 48"	
Blade Spindles	Single V-Belt	
Tires	1-3/8" Cast Iron Housing, Greaseable Ball Bearings Optional Mulching Blades	
Fuel Capacity	3 U.S. Gallons	
Pump Drive	Belt Drive	
Parking Brake	Manually Activated	
Ground Speed	Forward 0-6 mph; Reverse 0-4 mph	
Bagging Options	Available	
Rear Bumper	Extended Height Bumper - Optional	

See dealer for complete warranty information.

Color:



Shown with extended height bumper.

- Square tubing welded frame design provides increased durability.
- Easy clean-out deck top allows air and debris to move across for improved belt cooling.
- Anti-scalp rollers keep scalping to a minimum.
- Floating deck design provides excellent flotation over uneven terrain.
- Accessible blade spindle zerks make greasing easy.
- Lever activated park brake.

# A Close Cut Everytime.



The ZSR super Razor is designed for those small acreage homeowners or smaller contractors who want just a little more! The ZSR offers a wider deck choice, larger rear tires, a floating front axle and "commercial" quality gears.

	ZSR54	ZSR60
Cutting Width	54"	60"
Cutting Height	1-1/2" - 4-1/2" in 1/4" Increments	
Engine	23 HP & 23.5 HP Kawasaki	
Deck Thickness	10 Gauge Decks w/11 ga. Doubler Plate & 3/16" Reinforcement Plate Connecting Spindle Housing Mounts	
Steering	Twin Lever	
Anti-Scalp Rollers	4	
Blades	Heat Treated, High Lift, Fusion Technology	
Pivoting Front Axle	Locked or Unlocked	
Blade Belt	Single V-Belt	
Blade Spindles	1-3/8" Spindle, Cast Iron Housing, Greaseable Ball Bearings	
Tires	Front: 13 x 5 - 6 Rib Tread, Rear: 20 x 10 - 10, Turf Tread	
Fuel Capacity	12 U.S. Gallons	
Cooling	Air Cooled	
Pump Drive	V-Belt from Engine Crankshaft	
Parking Brake	Manually Activated, Pawl Over Cog Wheel	
Ground Speed	Forward 0-7.2 mph, Reverse 0-4.5 mph	
Seat	Deluxe Cushion Seat w/Springs, Armrests	
Certified ROPS	Standard	

See dealer for complete warranty information.

Color:



Front edge of deck is reinforced with a heavy underside box section.



## Productivity Defined.

The AccuZ<sup>®</sup> ZT3 Series Zero Turn Mower is Land Pride's premier commercial-duty mower. The ZT3 is an excellent turf-care choice for ranchers, large estate owners, municipalities, campuses, and other landscape contractors. With a host of standard features, productivity comes naturally. The ZT3 60" deck meets the needs of customers who need to mow in tight areas, around obstacles, or want to maintain a lower cutting height over undulating terrain. The more productive 72"

ZT3 will meet the needs of customers with mostly level, open areas who want to get their mowing job done faster.



- Lockable floating front axle
- Standard remote commercial air filter
- Superior deck design with reinforced front edge
- Deluxe seat with springs
- Certified ROPS for added operator protection



Rear bumper tow hook

	ZT360	ZT372
Working Width (cm)	60" (152)	72" (183)
Cutting Height	1"-5" in 1/4" Increments	
Engine	Air Cooled, Commercial Filter 27 HP Kawasaki	
Deck Thickness	3/16" Decks & 1/4" reinforcement plate connecting spindle housing mounts	
Steering	Twin Lever	
Anti-Scalp Rollers	4	
Blades	Heat Treated, High Lift with Fusion <sup>®</sup> Edge Technology	
Front Fork Suspension	Tele-Caster <sup>®</sup>	
Pivoting Front Axle	Locked or Unlocked	
Blade Belt	Single V-Belt	
Blade Spindles	1-3/8" Stressproof <sup>®</sup> Shaft, Cast Iron Housing, Greaseable Ball Bearings	
Tires	Front: 13 x 6.50 - 6, Rib Tread, Rear: 24 x 12.00 - 12, Turf Tread	
Fuel Capacity	12 U.S. Gallons	
Drive System	Integrated Transmission	
Parking Brake	Internal Wet Disk, Manually Activated	
Ground Speed	Forward 0-12 mph, Reverse 0-6 mph	
Seat	Deluxe seat w/suspension springs, seat belt	
Optional Seat	Molded Vinyl with comfort suspension adjustment	
Certified ROPS	Standard	

See dealer for complete warranty information.

Color: 



### Tele-Caster<sup>®</sup> Front Fork Suspension

We know that a smooth looking lawn doesn't necessarily mean a smooth feeling lawn. We've taken comfort one step further with our patented Tele-Caster<sup>®</sup> Front Fork Suspension. This standard feature allows the wheel forks to absorb the rough terrain, allowing the deck to continue to cut even, and gives you a more comfortable ride. This translates into less fatigue, and puts you in a better frame of mind when the job is done! (Patent No. 8,167,324)





**Ideal for clearing grass, weeds & light brush.**

**In the City or the Country**

Economically priced rotary cutter for daily use in small lots and country sides, capable of cutting 1" diameter material.

- Floating 3-point permits deck to hug the terrain
- Fully welded deck to side skirt
- Dishpan with dual blades
- 360° Degree swivelling tailwheel
- Optional bolt on skid shoes for 60" & 72"



CUTTERS

	RCR1243	RCR1260	RCR1272
<b>Horsepower</b>	20-50 HP		
<b>Hitch</b>	Cat. 1 & Cat. 1 Limited		
<b>Working Width (cm)</b>	48" (122)	60" (152)	72" (183)
<b>Overall Width</b>	53-5/8"	64-1/4"	76-1/2"
<b>Overall Length</b>	89-1/8"	103-3/8"	114-1/2"
<b>Weight - lb (kg)</b>	400 (181)	478 (217)	564 (256)
<b>Cutting Height</b>	1-1/4" - 10"		
<b>Cutting Capacity</b>	1" Diameter		
<b>Deck Thickness</b>	12 Gauge		10 Gauge
<b>Deck Height</b>	7-1/4"		
<b>Safety Guards</b>	Front and Rear Rubber Guards		
<b>Skids</b>	1/4" x 2" Weld on		
<b>Blades</b>	1/2" x 3" Heat Treated Alloy Steel Free Swinging Blades		
<b>Blade Tip Speed</b>	13,256 fpm	16,536 fpm	15,033 fpm
<b>Dishpan</b>	Round 10 Ga. x 24" Diameter, Dish Shaped		
<b>Gearbox</b>	540 RPM, PTO Driven Gearbox, Cast Iron Housing		
<b>Driveline</b>	ASAE Cat. 3, Standard - 1/2" Shear Bolt Protection Optional - Bolt 2 Plate, Slip Clutch		
<b>Tailwheel</b>	15" Laminated Tire w/Cast Iron Hub		



See dealer for complete warranty information.

Color Options:



Efficient handling and dispersing of material.



	RCR1542	RCR1548
<b>Horsepower</b>	20-50 HP	
<b>Hitch</b>	Cat. 1 & Cat. 1 Limited	
<b>Working Width (cm)</b>	42" (107)	45-1/2" (116)
<b>Overall Width</b>	47-1/2"	53-1/2"
<b>Overall Length</b>	85-1/4"	91-3/4"
<b>Weight* - lb (kg)</b>	402 (182)	424 (192)
<b>Cutting Height</b>	1-3/4" - 11-1/2"	
<b>Cutting Capacity</b>	2" Diameter	
<b>Deck Thickness</b>	12 Gauge	
<b>Deck Height</b>	7-1/4"	
<b>Safety Guards</b>	Rubber Front and Rear	
<b>Skids</b>	1/4" x 2" Weld on	
<b>Blades</b>	1/2" x 3" Heat Treated Alloy Steel Free Swinging Blades -	
<b>Blade Tip Speed</b>	11,459 fpm	13,090 fpm
<b>Dishpan</b>	Round 10 Ga. x 24" Dia. Dish Shaped -	
<b>Gearbox</b>	540 RPM PTO Driven Gearbox Cast Iron Housing	
<b>Driveline</b>	ASAE Cat. 3, Standard - 1/2" Shear Bolt Protection Optional - Bolt 2 Plate Slip Clutch	
<b>Tailwheel</b>	4" x 16" Molded Rubber Tire	

See dealer for complete warranty information.

Color Options:



- Floating 3-point allows deck to hug the terrain.
- 2 Position top link for greater lifting leverage on small tractors
- Shearpin or slip-clutch driveline
- High blade tip speed
- Driveline storage hook
- Fully welded deck adds additional strength





Ideal for cleaning around the farm, the pond, or empty lots in the city.



	RCR186E	RCR191Z	RCR1884
Horsepower	20-65 HP		45-90 HP
Hitch	Cat 1		
Working Width (cm)	57" (145)	69" (173)	84" (213)
Overall Width	65"	77"	89"
Overall Length	99-3/8"	110"	135"
Weight - lb (kg)	599 (272)	737 (334)	851 (386)
Cutting Height	1-1/2" - 13"	1-1/2" - 11-1/2"	2" - 11"
Cutting Capacity	2" Diameter		
Deck Thickness	10 Gauge		
Deck Height	7-1/2"	9"	9-1/8"
Safety Guards	Rubber or Chain Rear Metal Band - Standard		
Skids	1/4" x 2" Weld on		
Blades	Heat Treated Alloy Steel Free Swinging Blades		
	1/2" x 3"	1/2" x 4"	
Blade Tip Speed	16,363 fpm	14,853 fpm	17,113 fpm
Dishpan	Round 10 Ga x 24" Dia, Dish Shaped	Oval 10 Ga, Dish Shaped	
Gearbox	540 RPM, PTO Driven Gearbox		
Driveline	Standard - 1/2" Shear Bolt Protection Optional - Bolt 2 Plate Slip Clutch		
	ASAE Cat 3		ASAE Cat 4
Tailwheel	4" x 16" Solid Rubber Tire, Cast Iron Hub	4" x 8" x 15" Laminated Tire or Dual Laminated Optional, Cast Iron Hub	



10 Gauge dishpan with 1" thick blade bar slides over stumps, rocks and debris.



See dealer for complete warranty information.

Color Options:



- Floating 3-point allows deck to hug the terrain
- Fully welded deck adds additional strength
- High blade tip speed ensures clean cut
- Single or dual tailwheel on 84"
- Heavy-duty tailwheel spindle
- Rubber or chain guards protect against flying debris
- All-welded formed channels front to rear add superior strength
- Lower clevises for easy hookup



# The Perfect Cutter for Rural Grass Maintenance - in a Smooth Top Design.

- Smooth top for easier cleaning
- Floating top link for following ground undulations
- ASAE Category 3 driveline
- Fully welded deck
- Available rubber or chain guards - front and rear
- High blade tip speed
- 84" Features single or dual tailwheel option



2'



	RCF2060	RCF2072	RCF2084
<b>Horsepower</b>	20-65 HP		45-90 HP
<b>Hitch</b>	Cat. 1 - Floating Top Link		Cat. 1 & 2 Floating Top Link
	Clevis Type Lower Links, Quick Hitch Adaptable		
<b>Working Width (cm)</b>	60 (152)	72 (183)	84 (213)
<b>Weight - lb (kg)</b>	620 (281)	745 (338)	Sgl tailwheel: 1,047 (475) Dual tailwheel: 1,155 (524)
<b>Cutting Height</b>	1-1/2" - 12"		
<b>Cutting Capacity</b>	2'		
<b>Deck</b>	All Welded		
<b>Deck Thickness</b>	10 Gauge		
<b>Deck Height</b>	9-11/16"	11"	11-15/16"
<b>Safety Guards</b>	Rear Metal Banding - Standard		
<b>Final Guarding</b>	Front: Rubber or Chain Rear: Rubber or Chain		
<b>Skids</b>	Weld-on (Bolt on Accessory Skid Shoes Available)		
<b>Blades</b>	2 ea. (1/2" x 3" Heat Treated) Free Swinging High-Lift		2 ea. (1/2" x 4" Heat Treated) Free Swinging High-Lift
<b>Blade Bolt</b>	Keyed w/ Hardened Flat Washer & Lock Nut		
<b>Blade Speed</b>	16,363 fpm	14,955 fpm	17,113 fpm
<b>Dishpan</b>	Round, 10 Ga. x 24" Dia., Dish Shaped		Oval, 3/16" x 27"
<b>Gearbox Rating</b>	65 HP	65 HP	90 HP
<b>Gearbox</b>	540 RPM, Beveled Gears, Cast Iron Housing		
<b>Driveline</b>	ASAE Cat. 3: Shear Bolt or 2-Plate Slip-Clutch		ASAE Cat. 4: 2-Plate Slip- Clutch
<b>Tailwheels</b>	4" x 15" Laminated Tire or 4" x 18" Molded Rubber - 360 Degree Swivel		Single or Dual 4" x 15" Laminated Tire w/ Cast Iron Hub - 360 Degree Swivel

See dealer for complete warranty information.

Color Options:



## Roundback design allows for more efficient handling and dispersing of material.

Land Pride's 26 Series Rotary Cutters are the perfect fit for around the farm clean-up or keeping the horse pasture under control. The 3" cutting capacity also allows it to be the choice of many municipalities from parks to easement control applications.

The floating top link allows the cutter to follow uneven terrain. The beefy lower hitch clevises allow easy hook-up to the tractor, as well as adding another degree of strength to the overall hitch area.

Take a close look at our welding, and the precise fit-up of all the fabricated parts and you'll understand the perfection we expect out of our manufacturing facilities. Our cast iron gearbox has internal components crafted to a precision fit; teeth and gears that mesh together perfectly for a quiet and efficient power source.



	RCR2660	RCR2672	RCR2684
<b>Horsepower</b>	40-130 HP		60-130 HP
<b>Hitch</b>	Cat 1 & 2		Cat 2 & 3
<b>Working Width (cm)</b>	60" (154)	72" (183)	84" (213)
<b>Overall Width</b>	67"	79"	90-3/4"
<b>Overall Length</b>	114"	126"	Single 133", Dual 116"
<b>Weight - lb (kg)</b>	1002 (454)	1046 (474)	1370 (621) Single ga whl 1500 (680) Dual ga whl
<b>Deck Thickness</b>	10 Gauge		
<b>Cutting Height</b>	2"-12"		
<b>Cutting Capacity</b>	3" Diameter		
<b>Safety Guards</b>	Front: Chain, Rear: Single or Double Chain		
<b>Skids</b>	Full Length Weld & Replaceable Shoes		
<b>Deck Height</b>	9-1/8"		10-1/8"
<b>Blades</b>	1/2" x 4" Heat Treated Alloy Steel Free Swinging Blades		
<b>Blade Tip Speed</b>	12,384 fpm	14,861 fpm	14,369 fpm
<b>Dishpan</b>	3/16" x 24" Round, Dish Shaped	3/16" x 30-1/2" Round, Dish Shaped	3/16" x 24" x 38" Oval, Dish Shaped
<b>Gearbox</b>	540 RPM PTO Driven, 1-3/8" 6 Spline Cast Iron Housing		
<b>Driveline</b>	ASAE Cat 4 4-Plate Slip Clutch		
<b>Tailwheel</b>	4" x 8" x 15" Laminated Tire Cast Iron Hub		

See dealer for complete warranty information.

**Color Options:**



- Replaceable skid shoes
- Clevis hitch for easy hook-up
- Full length skids with replaceable shoes
- Rugged laminated tailwheel
- Fully welded deck
- 3-Point with dual 15" tailwheels on 84"



3/16" Dishpan with 1" x 4" blade bar provides superior strength for encountering objects in the blade path. Round on 60" & 72"; oval on 84".



## Roundback with a Smooth Top

The RCF27 Series Rotary Cutter is a smooth top version of our RCR26 Series, offering the same great cut and ideal for grass, weeds, crops, brush and small trees up to 3 inches in diameter. These units come equipped standard with a 3/16" thick heavy-duty stump jumper and replaceable bolt-on skid shoes. Optional shields are available for the front and rear.



	RCF2760	RCF2772	RCF2784
<b>Horsepower</b>	35-130 HP		60-130 HP
<b>Hitch</b>	Cat. 1 & 2		Cat. 2 & 3 Pull-Type
<b>Working Width</b>	60" (152)	72" (183)	84" (213)
<b>Weight - lb (kg)</b>	955 (433)	1072 (486)	1354 (614) Pull-Type: 1632 (740)
<b>Cutting Height</b>	1-1/2" - 12"		
<b>Cutting Capacity</b>	3"		
<b>Deck</b>	All Welded, Smooth Top		
<b>Deck Thickness</b>	10 Gauge		
<b>Deck Height</b>	11-1/4"	10-1/8"	
<b>Side Thickness</b>	1/4"		
<b>Safety Guards</b>	Front: Chain or Rubber, Rear: Chain		
<b>Skids</b>	Replaceable		
<b>Blades</b>	Free Swinging High Suction, 1/2" x 4" - Heat Treated		
<b>Blade Bolt</b>	Keyed with Hardened, Flat Washer & Lock Nut		
<b>Blade Tip Speed</b>	12,354 fpm	14,861 fpm	14,369 fpm
<b>Dishpan</b>	3/16" x 24" Round, Dish Shaped	3/16" x 30-1/2" Round, Dish Shaped	3/16" x 24" x 38" Oval, Dish Shaped
<b>Gearbox</b>	540 RPM, 130 HP 1-3/8" - 6 Spine		
<b>Gearbox Output Shaft</b>	2"		
<b>Driveline</b>	ASAE Cat. 4 with 4 Plate Slip-Clutch		
<b>Tailwheel(s)</b>	15" Laminated, w/Cast Iron Hub, Tapered Roller Bearings		

See dealer for complete warranty information.

Color Options:



- Replaceable skid shoes
- Smooth top design
- All welded deck
- Clevis style lower hitch
- Reinforced rear chain guard
- Floating top hitch
- Pull-type model available in 84" model
- Dual wheels optional on 3-point 84" model, Standard on Pull-Type

## Our RCF36 Series Rotary Cutter is a Brute!

This cutter features a 190 HP gearbox capable of cutting heavy grass and weeds, row crop stubble, thick brush and small trees up to 4" in diameter.



**4" CUTTING CAPACITY**



	RCF3660	RCF3672	RCF3684
<b>Horsepower</b>	50-190 HP	60-190 HP	Lift: 70-190 HP Pull: 50-190 HP
<b>Hitch</b>	Cat 1 & 2		Cat. 2 & 3, Pull-Type
<b>Working Width (cm)</b>	60" (152)	72" (183)	84" (213)
<b>Overall Width</b>	66-1/2"	78-1/2"	90-1/2"
<b>Overall Length</b>	112-1/2"	124-3/4"	130", 179-1/2" Pull
<b>Weight - lb (kg)</b>	1233 (559)	1337 (606)	2000 (907), Pull-type 2104 (954)
<b>Cutting Height</b>	2" - 12"		
<b>Cutting Capacity</b>	4"		
<b>Deck</b>	All Welded, Smooth Top		
<b>Deck Thickness</b>	3/16"		
<b>Deck Height</b>	13-3/8"		
<b>Side Thickness</b>	1/4"		
<b>Safety Guards (Choose)</b>	Front: Rubber, Sgl or Dbl Chains Rear: Sgl or Dbl Chains or Band		
<b>Skids</b>	Replaceable		
<b>Blades</b>	Free Swinging High Lift, 1/2" x 4", Heat Treated Steel		
<b>Blade Bolt</b>	Keyed with Hardened, Flat Washer & Lock Nut		
<b>Blade Tip Speed</b>	13,572 fpm	14,861 fpm	14,369 fpm
<b>Dishpan</b>	3/16" x 30-7/16", Round, Dish Shaped		
<b>Gearbox</b>	540 RPM, 190 HP, 1-3/4" - 20 Spline		
<b>Gearbox Output Shaft</b>	2-3/8"		
<b>Driveline</b>	ASAE Cat 5 with 4 Plate Slip-Clutch		
<b>Tailwheel(s)</b>	15" Laminated, w/Cast Iron Hub, Tapered Roller Bearings, 21" on Pull-type		

See dealer for complete warranty information.

**Color Options:**



- Replaceable skid shoes
- Smooth top design
- All welded deck
- Reinforced rear chain guard
- Heavy-duty tailwheel mount
- Floating top hitch
- Pull-type available in 84" model
- Optional Shredder Kit makes quick work of prunings and crop residue.



CUTTERS



## Right for the Job.

The RCD1884 Rotary Cutter offers a smooth deck for easy cleaning, shorter in length than single spindle cutters to help you maneuver tight spaces, as well as being ideal in orchard-type applications.



	RCD18
Horsepower	35-60 HP
Hitch	Cat. 1 QH
Working Width (cm)	84" (213)
Weight - lbs (kg)	900 (408)
Cutting Height	2"-12"
Cutting Capacity	1-1/2"
Offset	10"
Deck	All Welded
Deck Thickness	10 Gauge
Deck Height	11-5/8"
Safety Guards	Front: Rubber or Chain Rear: Metal Band
Skids	Weld-on
Additional Skids	Bolt-on
Blades	2 Each, 1/2" x 4" x 16" Heat Treated Free Swinging Alloy Steel Suction Blades
Blade Bolt	Keyed with Hardened Flat Washer & Lock Nut
Blade Speed	11,693 fpm
Dishpan	10 Ga. x 24", Round Dish Shaped
Gearbox	640 RPM, 80 HP Main, 46 HP Side, Beveled Gears, Cast Iron Housing
Driveline	Cat. 3 with 2-Plate Slip-Clutch
Tailwheels	16" Laminated Tire or 4" x 16" Molded Rubber

See dealer for complete warranty information.

Color Options:



- Deep deck design
- All welded deck
- Short coupled for tight spaces
- Clevis style hitches
- Offset to cover your tractor tire and get closer to obstructions



## A perfect fit for any size farm.

The RGR25 Series is just perfect for those medium sized chores. Designed for performance in pastures, set aside acres, roadsides, and routine farm maintenance.

**Pull-type** — The Pull-type model features two leveling rods that connect the rear axle to the front tongue. This enables the deck to stay level over uneven ground conditions. The height controlling axle cylinder is attached to two deck springs that help cushion the cutter in rough terrain.

**3-Point** — The 3-point unit utilizes two castering laminated tailwheels for smooth, trouble-free performance. The easy to attach clevis hitch is designed to fit Cat. 1 or 2 tractors on the 96" model, and Cat. 2 or 3 tractors on the 10' model.

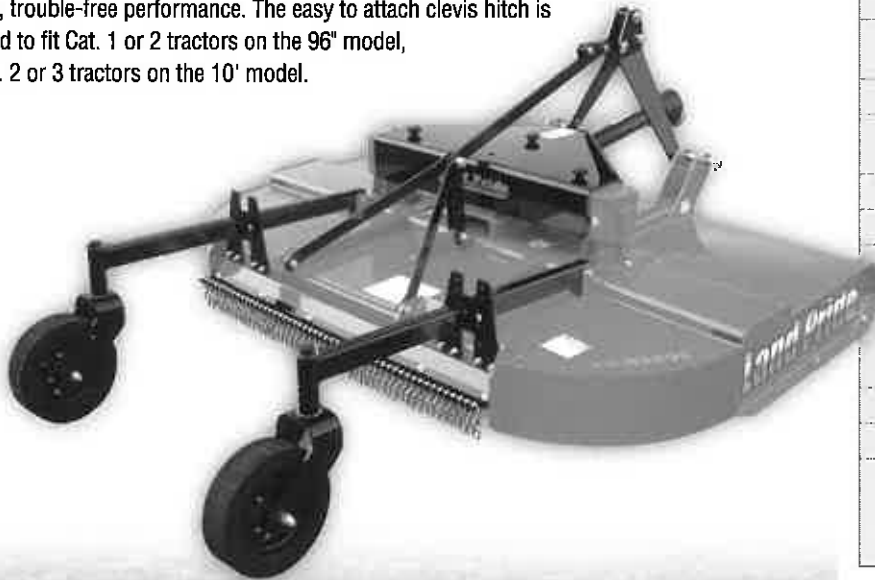

	RGR2506	RGR2510
<b>Horsepower</b>	Pull 40-110 HP 3-Pt 50-110 HP	Pull 50-110 HP 3-Pt 60-110 HP
<b>Hitch</b>	Cat 1 & 2	Cat 2 & 3
<b>Working Width (cm)</b>	7'10" (239)	9'10" (300)
<b>Overall Width</b>	8'3-3/4"	10'3-1/2"
<b>Overall Length</b>	Lift - 8'10", Pull - 11'8-3/4"	Lift - 9'4", Pull - 12'6"
<b>Weight - lb (kg)</b>	3-Pt 1,380 (625) Pull 1,665 (755)	3-Pt 1,750 (793) Pull 2,035 (923)
<b>Deck Material Thickness</b>	10 Gauge	
<b>Deck Height</b>	9-5/8"	
<b>*Safety Guards (choose)</b>	Front or Rear Chain / Front or Rear Rubber	
<b>Skids</b>	Replaceable	
<b>Gearbox</b>	540 rpm, Cast Iron Housing, Beveled Gears	
<b>Cutting Height</b>	2" - 12"	2" - 10-1/2"
<b>Cutting Capacity</b>	1-1/2"	
<b>Blades</b>	1/2" x 4" Heat Treated, Free-Swinging Suction Blades	
<b>Blade Tip Speed</b>	540 RPM 14,592 fpm	540 RPM 17,749 fpm
<b>Dishpan</b>	3/16" Round, Dish Shaped	
<b>Driveline</b>	ASAE 4 Plate Slip-Clutch	
<b>Tailwheel</b>	Lift-Type 2 each, 4" x 8" x 15-1/4" Laminated Pull-Type 2 each, 6" x 9" x 21" Laminated or 24" Aircraft Tires	

CUTTERS



Narrow tongue on pull-type allows for tight turns

See dealer for complete warranty information.

Color Options:



- Slip-clutch and impact absorbing cross shafts to outer gearboxes
- Constant Velocity U-Joint option on 10' Pull-type
- Slip-clutch protection on main driveline
- Fully welded 10 Gauge deck
- Round back design
- Chain or rubber shield option
- Full length skids with replaceable shoes
- 1" x 4" Blade bar

Front and rear guarding is highly recommended in any application. Please be sure you understand how your Rotary Cutter is equipped upon purchase. All Land Pride Rotary Cutters are tested and pass rigorous voluntary testing requirements as specified by ISO, ASAE and SAE.





## Performance in a Medium-Duty Cutter.

The RCF30 Series is the perfect medium-duty cutter for pastures and roadside applications. Available in 3-point, semi-mount or pull-type, the RCF30 features a 2-1/2" cutting capacity and 1/4" side skirts. Plus, every RCF30 comes with the rugged dependability that Land Pride Rotary Cutters are known for.



Semi-Mount with Heavy-Duty Toolbar Axle



3-Point with Dual Beam Axle

	RCF3096	RCF3010
Horsepower	3-Pt 50-110 HP Semi & Pull: 40-110 HP	3-Pt 60-110 HP Semi & Pull 50-110 HP
Hitch	Cat 1 & 2 OH	Cat 2 & 3 OH
Working Width (cm)	8' (244)	10' (305)
Overall Width	8'7"	10'6-1/2"
Overall Length (3-Pt w/Twin Beam Axle)	102"	122"
Weight -lb (kg) (3-Pt w/Twin Beam Axle)	1,587 (720)	2,004 (909)
Blade Tip Speed	16,360 fpm	540 17,100 FPM, 1000 17,300 fpm
Deck Material Thickness	10 Gauge	
Side Skirt Thickness	1/4"	
Gearbox	540 RPM	540 RPM or 1,000 RPM
Gearbox Rating	Outboard: 110 HP, Center 160 HP	
Cutting Height	2" - 12"	
Cutting Capacity	2-1/2" Diameter	
Shielding	Front: Rubber, Chain or Double Chain Rear: Rubber, Chain or Double Chain	
Skids	Replaceable	
Deck Height	11-1/4"	11-1/2"
Blades	1/2" x 4" Heat Treated Alloy Steel Free Swinging Blades	
Dishpan	3/16" Round, Dish Shaped	
Driveline	3-Point & Semi-Mount: ASAE Cat. 4 Pull-type: ASAE Cat. 4 Equal Angle or CV	
Driveline Protection	Slip-Clutch and Impact Absorbing Cross Shafts to Outer Gearboxes	
Tires	3-Point: 15" or 21" Laminated Pull-Type: 21" Laminated, 24.5" Foam Filled, or 29" Aircraft Semi-Mount: 15" or 21" Laminated	

See dealer for complete warranty information.

Color Options:

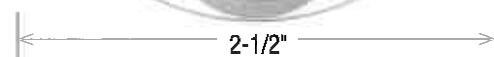

## Bigger and Better.

Building on the success of the RCR35 Series Land Pride is proud to offer the RCF36 Dual-Spindle Rotary Cutter – an updated, heavy-duty, flat-top version of the original RCR35. With larger gear boxes, larger cutting capacity, and a deeper deck, the RCF36 is the ideal dual-spindle cutter for narrow areas in pastures, along roadsides, or in tree groves.



Semi-Mount

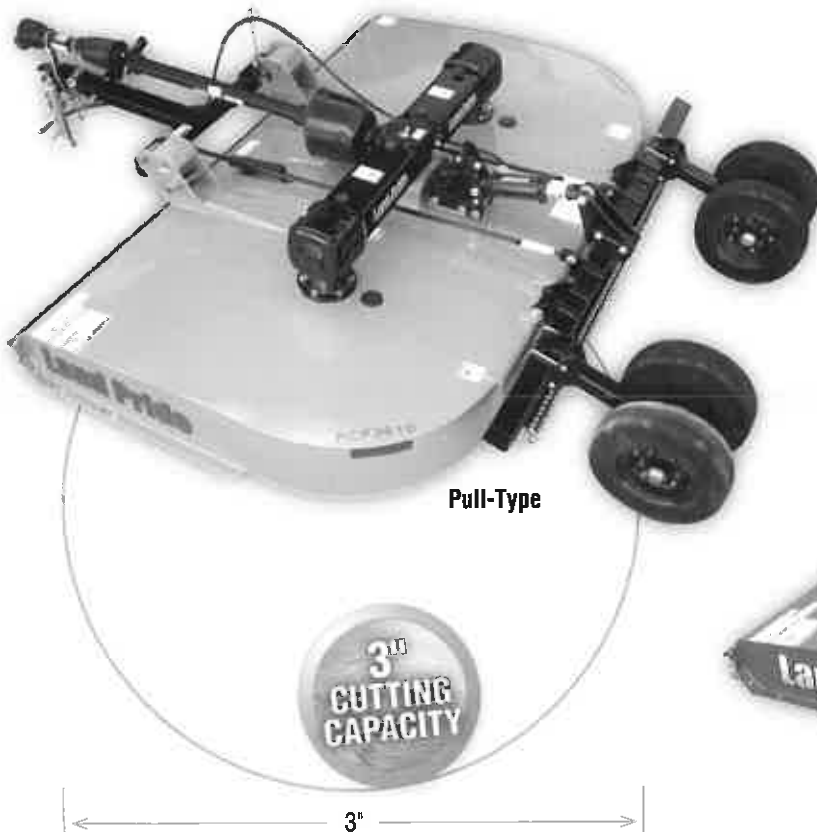

Pull-Type

3" CUTTING CAPACITY

3"

	RCF366	RCF3610
<b>Horsepower</b>	3-Pt 50-130 HP Semi 40-130 HP Pull 35-130 HP	3-Pt 60-130 HP Semi & Pull 50-130 HP
<b>Hitch</b>	Cat. 1 & 2 QH	Cat 2 & 3 QH
<b>Working Width (cm)</b>	8' (244)	10' (305)
<b>Overall Width</b>	8'7"	10'6-1/2"
<b>Overall Length (3-Pt w/Rigid Axle &amp; Chains)</b>	8'10"	10'2"
<b>Weight - lb (kg) (3-Pt w/Rigid Axle &amp; Chains)</b>	1,838 (834)	2,310 (1048)
<b>Cutting Height</b>	2" - 12"	
<b>Cutting Capacity</b>	3" Diameter	
<b>Deck Thickness</b>	10 Gauge	
<b>Deck Height</b>	13"	
<b>Side Thickness</b>	1/4"	
<b>Safety Guards (Choose)</b>	Front: Rubber, Chain or Double Chain Rear: Rubber, Chain or Double Chain	
<b>Skids</b>	Replaceable	
<b>Blades</b>	1/2" x 4" Heat Treated Alloy Steel Free Swinging Blades	
<b>Blade Tip Speed</b>	540 17,100 fpm, 1000 17,400 fpm	540 17,100 fpm, 1000 17,400 fpm
<b>Dishpan</b>	3/16" Round, Dish Shaped	
<b>Gearbox</b>	540 RPM or 1,000 RPM	
<b>Gearbox Rating</b>	Outboard 205 HP, Center 210 HP	
<b>Driveline</b>	3-Point & Semi-Mount ASAE Cat. 4 Pull-Type ASAE Cat. 4 Equal Angle or CV	
<b>Driveline Protection</b>	Slip-Clutch and Impact Absorbing Cross Shafts to Outer Gearboxes	
<b>Tires</b>	3-Point & Semi-Mount: 15" or 21" Laminated Pull-Type: 21" Laminated, 24" Foam Filled or 29" Aircraft	

See dealer for complete warranty information.

Color Options:



3-Point



## Built Land Pride Tough.

The RCFM4014 3-Spindle, Rigid Deck Rotary Cutter complements our line of Land Pride Rotary Cutters. This cutter features a 14' cutting width and is built Land Pride-tough for years of dependable use in the most demanding conditions – from cotton and row-crop shredding to pasture clearing.

The heavy-duty RCFM4014 boasts a 3" cutting capacity, Cat. 4 Cross Shafts with a spring-loaded flex coupler, 1 3/4" 20 spline Cat. 5 input shaft, 1 3/4" output shaft, tip speed of 15,000 fpm, and gearbox ratings of 210/250 HP for the outboard boxes and T-box respectively.

The RCFM4014 can be equipped with either cutting blades bolted to a dish pan for cutting grass, weeds, and brush, or with a blade bar and shredder kit option for shredding all widths of row crops into small pieces. Fixed blades can also be added to the blade bar and shredder kit option for shredding row crops in 30" row widths or 36" to 40" row widths to reduce stalks into even smaller pieces.



**NEW!**

**3" CUTTING CAPACITY**



	RCFM4014
Horsepower	80-250 HP
Hitch	Cat. 2 & 3
Working Width (cm)	14' (427)
Overall Width	14' 6-1/2"
Overall Length	10'-1/2"
Weight - lb (kg)	3,065 (1,404)
Cutting Height	2' - 12'
Cutting Capacity	3" Diameter
Deck Thickness	10 Gauge
Deck Height	12"
Side Thickness	1/4"
Safety Guards (Choose)	Front: Rubber or Single Chain Rear: Rubber, Single Chain or Metal
Skids	Replaceable
Blades	1/2" x 4" Heat Treated Free Swinging Blades
Blade Tip Speed	15,000 fpm
Dishpan	3/16" Round
Gearbox	1,000 RPM
Gearbox Rating	Outboard: 210 HP, Center: 250 HP
Driveline	~ ASAE Cat. 5
Driveline Protection	4-Plate Slip-Clutch
Tires - 2 or 3	21" Laminated

See dealer for complete warranty information.

Color Options:

**5 YEAR**  
Metal Gearbox  
Warranty

## Quickly Reach Inclines.

New from Land Pride, the DB2660 Ditch Bank Rotary Cutter enhances our growing line of Rotary Cutters. This new hydraulic-driven cutter boasts a number of features that will make mowing ditch banks, pond dams, or other hard to reach inclines fast, easy, and efficient.



Built for either 540 or 1000 RPM tractors, the DB2660 features a 58" cutting width, 1" cutting diameter, and 32" cutting reach. The 1/2" by 4" blades rotate clockwise at 15,000 FPM, directing debris away from the tractor. Minimum cutting height is dictated by the tractor's 3-pt height.

	DB(M)2660
Horsepower	75 HP, Min. Tractor Weight 7,000 lbs.
Hitch	Cat 2 Std., Cat 2 & 3 QH Clevis Type Lower Hitch
Working Width (cm)	58" (147)
Min. Transport Width	10'1"
Min. Tractor Weight - lb	7,000
Weight - lb (kg)	1,788 (811)
Tractor Hydraulics Req'd	See specific model
Hydraulic Pump Input	540 RPM or 1000 RPM
Hyd. Oil Capacity	35 Gallons
Hydraulic Oil Flow	15 GPM
Hydraulic System	2 Duplex Required
Overload Protection	Relief Valve
Oil Cleansing	Return Line Filter, Replaceable
Oil Check	Dipstick
Min. Cutting Height	Depends on 3-Pt Height
Cutting Capacity	1" Diameter
Horiz. Extension	32" Maximum
Max. Horizontal Reach from Tractor Center	13'2"
Operating Tilt Arc	175 Degrees
Deck Thickness	10 Gauge
Safety Guards	Rubber, Single or Dbl Chain
Blades	2 Each, 1/2" x 4"
Blade Bolt	Keyed with Hardened Flatwasher & Lock Nut
Blade Tip Speed	15,600 FPM
Blade Rotation	Clockwise
Dishpan	3/16" x 21" Round, Dish Shaped
Driveline	Cat 4
Storage	Parking Stand
Options	Rear Tailwheel, Side Gauge Wheel

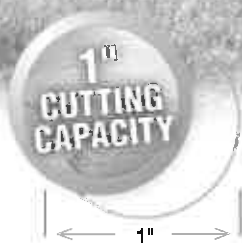

Color Options:

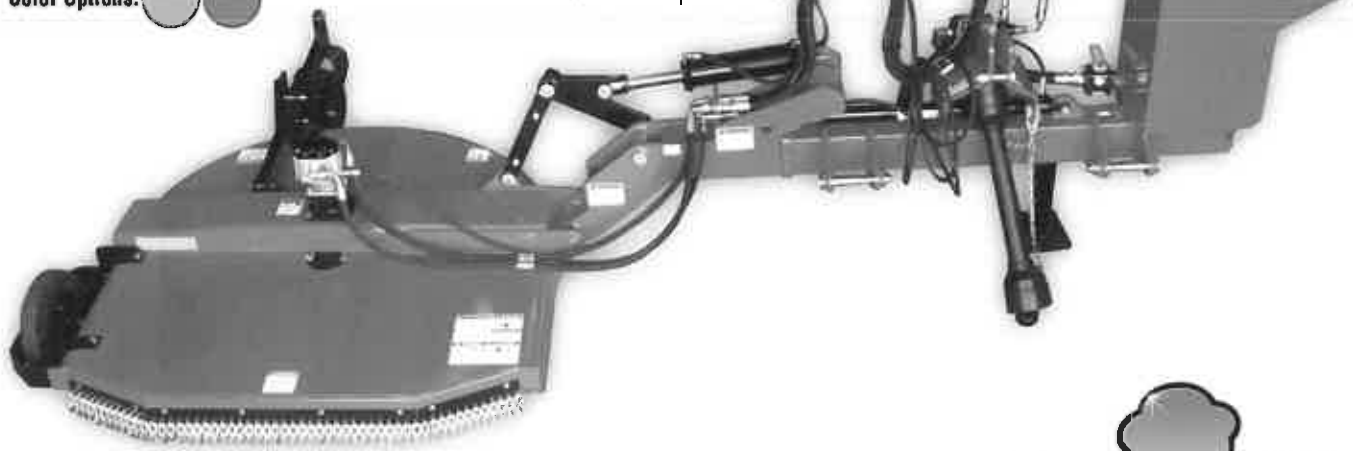

## Hydraulic Driven Parallel Arm Rotary Cutter.

Designed to “reach out” and cut along roadsides, over guard rails, down ditchbanks, and along side ponds, Land Pride’s RCP26 has features not found on your typical Parallel Arm Rotary Cutter.

First of all, it has a constant attitude! When the two cylinders that operate the two arm sections are activated, the attitude of the deck does not change, thanks to the parallel arm design. Lift the cutter head up, in or out to negotiate an obstacle, and your cutter deck position does not change; set the cutter head down at the same attitude as it was prior to the obstacle. This makes your work efficient!

The hydraulic breakaway feature of the RCP is also not found on your standard parallel arm cutter. The cutter deck is restored to its original position with the help of a hydraulic cylinder. The cutter deck can also swing rearward enabling you to mow into a tight corner, again putting it back to its original setting with the hydraulic cylinder.

The cutter deck is operated by a hydraulic motor, which is run by a pump powered by the PTO of the tractor utilizing the tractor hydraulics, or an optional self contained system. A flow control valve is standard equipment to protect the hydraulic system of the cutter from the high GPM many of the newer tractors now utilize. The 35 gallon oil reservoir keeps the unit running cool, and the in-line filter continually cleans the oil each time it is returned to the reservoir.

The optional electronic package enables each of the arm and deck hydraulic cylinders to be activated by a push button switch. You get instant response from the cylinder, which can be very difficult with the tractor’s hydraulic controls.

Moving this cutter up and around obstacles, in and out next to water or roadsides is what this cutter is all about. Save time and work efficiently with the parallel arm cutter that does more!



Optional gauge wheel deck allows the cutter to float over undulations without having to constantly monitor terrain conditions.



	RCP2660
<b>Horsepower</b>	75-150 HP
<b>Hitch</b>	Cat. 2 & 3
<b>Working Width (cm)</b>	58' (147)
<b>Min. Transport Width</b>	10'1"
<b>Min. Tractor Weight - lb (kg)</b>	8000 (3629)
<b>Tractor Hydraulics Req'd</b>	Max 4, Min 1
<b>Hydraulic Pump Input</b>	540 RPM or 1000 RPM
<b>Hyd. Oil Capacity</b>	35 Gallons
<b>Hydraulic Oil Flow</b>	15 GPM
<b>Hydraulic System</b>	Tractor Provided or Self Contained
<b>Overload Protection</b>	Relief Valve
<b>Oil Cleansing</b>	Return Line Filter, Replaceable
<b>Oil Check</b>	Dipstick
<b>Min. Cutting Height</b>	2"
<b>Cutting Capacity</b>	2" Diameter
<b>Horiz. Cutting Reach</b>	16'3" Maximum
<b>Vertical Cutting Reach</b>	11'5" Maximum
<b>Below Ground Level Reach</b>	9'1" Maximum
<b>Operating Tilt Arc</b>	180 Degrees
<b>Deck Thickness</b>	10 Gauge
<b>Safety Guards</b>	Front and Rear Chain Guards
<b>Blades</b>	2 Each, 1/2" x 4"
<b>Blade Bolt</b>	Keyed with Hardened Flatwasher & Lock Nut
<b>Blade Tip Speed</b>	15,000 FPM
<b>Blade Rotation</b>	Clockwise
<b>Dishpan</b>	3/16" x 21" Round, Dish Shaped
<b>Driveline</b>	Cat. 2
<b>Storage</b>	2 Parking Stands
<b>Unit Protection</b>	Tension Bolt and Hydraulic Breakaway Cylinder
<b>Options</b>	Operator Shield Suitcase Weight Bracket Gauge Wheels

Color:



In-line filter cleans hydraulic fluid before it re-enters reservoir.



## 3 Foot longer reach than the RCP26 Series.



Great for those roadsides that want a manicured look further down the ditch, or being able to stay a little further away from the soggy banks of the pond.

### TOP QUALITY FEATURES ON RCP26 AND RCP30



Hydraulic breakaway feature pivots arm backward to avoid obstacles and protect cutter arm. Hydraulically pivots back into place.



Flow control valve compensates for various hydraulic systems.



Shut-off valve permits maintenance without oil loss.



The built in weight rack can be ordered to fit with various suitcase weight styles.



Grease zerks at all pivot points.



Optional Self-contained hydraulics.



Electronic cylinder controls provide instant response for adjustments on the go.

	RCP3060
Horsepower	95-175 HP
Hitch	Cat. 2 & 3
Working Width (cm)	58" (147)
Min. Transport Width	10'1"
Min Tractor Weight - lb (kg)	12,000 (5443)
Tractor Hydraulics Req'd	Max 4, Min 1
Hydraulic Pump Input	540 RPM or 1000 RPM
Hyd. Oil Capacity	35 Gallons
Hydraulic Oil Flow	15 GPM
Hydraulic System	Tractor Provided or Self Contained
Overload Protection	Relief Valve
Oil Cleansing	Return Line Filter, Replaceable
Oil Check	Dipstick
Min. Cutting Height	2"
Cutting Capacity	2" Diameter
Horiz. Cutting Reach	18'10" Maximum
Vertical Cutting Reach	13'5" Maximum
Below Ground Level Reach	11" Maximum
Operating Tilt Arc	180 Degrees
Deck Thickness	Front and Rear Chain Guards
Safety Guards	10 Gauge
Blades	2 Each 1/2" x 4"
Blade Bolt	Keyed with Hardened Flatwasher & Lock Nut
Blade Tip Speed	15 000 FPM
Blade Rotation	Clockwise
Dishpan	3/16" x 21" Round, Dish Shaped
Driveline	Cat. 2, 1 3/8" 21 Spline
Storage	2 Parking Stands
Unit Protection	Tension Bolt and Hydraulic Breakaway Cylinder
Options	Operator Shield Suitcase Wt. Bracket (Required) Gauge Wheels

Additional tractor weight (dual tractor wheel, calcium, etc.) may be needed.

Color:



- Hydraulic break away and reset
- Case drain deck motor
- Gauge wheel package allows unit to follow ground contour while operating in float position



## Mow Like the Big Boys!

Designed with smaller tractors and smaller areas to cut in mind, our 12' Rotary Cutter has a lot of the features found in our larger folding cutters. The 12' width, sharp turning radius, and low tongue weight makes this an ideal rotary cutter for compact tractor owners.



	RC2512
<b>Horsepower</b>	40-75 HP
<b>Hitch</b>	Pull-Type, Self-Leveling Hitch & Clevis
<b>Working Width (cut)</b>	12' (366)
<b>Min. Transport Width</b>	7'11"
<b>Overall Width</b>	12'7"
<b>Overall Length</b>	13'3"
<b>Machine Weight - lb (kg)</b>	2,540 (1152)
<b>Tongue Weight - lb</b>	793
<b>Cutting Height</b>	1-1/2" - 12"
<b>Cutting Capacity</b>	1-1/2"
<b>Hitch</b>	Standard Clevis
<b>Deck Thickness</b>	10 Gauge
<b>Deck Height</b>	11"
<b>Deck Shock Protection</b>	Spring Cushioned Center Axle
<b>Side Skirt Thickness</b>	3/16" Plate
<b>Safety Guards</b>	Front and Rear Chain - Std
<b>Skid Shoes</b>	Wings & Center, Replaceable
<b>Blades</b>	2 per Section, 1/2" x 3" Heat Treated Free Swinging Alloy Steel w/Uplift
<b>Blade Bolt</b>	Keyed with Hardened Flatwasher & Lock Nut
<b>Blade Overlap</b>	5"
<b>Blade Speed</b>	Center: 16,500 fpm, Wings: 18,000 fpm
<b>Dishpan</b>	10 Gauge, Round, Dish Shaped with 1" x 3-1/2" Blade Bar
<b>Wing Cutting Angle</b>	22 Deg. Down, 45 Deg. Up
<b>Wing Transport Locks</b>	Standard
<b>Wing Hydraulics</b>	2" x 8" Cylinder, Hoses & Fittings
<b>Height Adjustments</b>	2-1/2" x 8" Cylinder, Hose, Fittings & Stroke Control Spacers
<b>Gearbox</b>	540 rpm, 160 HP Divider, 75 HP Center & Wings
<b>Gearbox Input Shaft</b>	1-3/8" 6 Spline
<b>Gearbox Output Shaft</b>	1-1/2"
<b>Input Driveline</b>	Constant Velocity U-Joint, Cat. 4
<b>Connecting Driveline</b>	Cat. 3 Slip-Clutch
<b>Wheels (4)</b>	21" Laminated Tires 20.5" Aircraft Tires Tapered Roller Bearings & Cast Iron 5-Bolt Hubs with 1-3/4" Shaft

See dealer for complete warranty information.

Color Options:



- Center spring-cushioned axle
- Great size for country estates
- Dual hinge rods for levelling
- Narrow tongue design for tight turns



# RC2515 15' FOLDING ROTARY CUTTER

HP  
50-100

HITCH  
Pull-Type

CUTTERS

## Quality with value built in.

Land Pride has packaged our renowned quality and dependability into an economy 15' Cutter. With a 1 year hitch-to-tailwheel warranty, plus a 5 year gearbox warranty, the RC2515 will give you years of dependable service and acres and acres of cut grass.



Optional 29" Aircraft tires provide extra cushioning over laminate tires.



1-1/2"  
CUTTING  
CAPACITY

1-1/2"

	RC2515
Horsepower	50-100 HP
Hitch	Pull-Type, Self Leveling Hitch & Clevis
Working Width	15'
Min. Transport Width	8'4"
Overall Width	15'7"
Overall Length	15'6"
Machine Weight	3,255 lb
Tongue Weight	1,123 lb
Cutting Height	2" - 13"
Cutting Capacity	1 1/2"
Deck Thickness	10 Gauge
Deck Height	11 1/2"
Deck Shock Protection	Spring Cushioned
Side Skirt Thickness	1/2" Plate
Safety Guards	Front and Rear, Chain or Rubber
Skid Shoes	Wings & Center, Replaceable
Blades	2 per Section, 1/2" x 4" Heat Treated Free Swinging Alloy Steel w/Uplift
Blade Bolt	Keyed with Hardened Flatwasher & Lock Nut
Blade Overlap	6"
Blade Speed	Center & Wings 15,000 fpm
Dishpan	10 Gauge, Round, Dish Shaped with 1" x 4" Blade Bar
Wing Cutting Angle	22 Deg Down, 45 Deg Up
Wing Transport Locks	Standard
Wing Hydraulics	2 1/2" x 10" Cylinder, Hoses & Fittings
Height Adjustments	2 1/2" x 8" Cylinder, Hose, Fittings & Stroke Control Spacers
Gearbox	540 rpm, 160 HP Divider, 75 HP Center & Wings
Gearbox Input Shaft	1 3/8" 6 Spline
Gearbox Output Shaft	1 3/8"
Input Driveline	Constant Velocity U-Joint, Cat 4
Connecting Driveline	Cat 3 Slip-Clutch
Wheels (4 or 6)	21" Laminated Tires 29" Aircraft Tires

See dealer for complete warranty information.



The Land Pride gearbox features a 1 3/8" output shaft.



Deck-mounted spring cushion provides a smooth ride in rough terrain.



Wings are leveled with easy-to-access and easy-to-adjust turnbuckles.



All three connecting drivelines offer two-plate slip clutch protection.

Color Options:



5 YEAR  
Land Pride  
Warranty



# RC3615 15' FOLDING ROTARY CUTTER

HP  
50-160

HITCH  
Pull-Type

Give your pasture that well-groomed look!

2-1/2" CUTTING CAPACITY

Deck Rings Available!

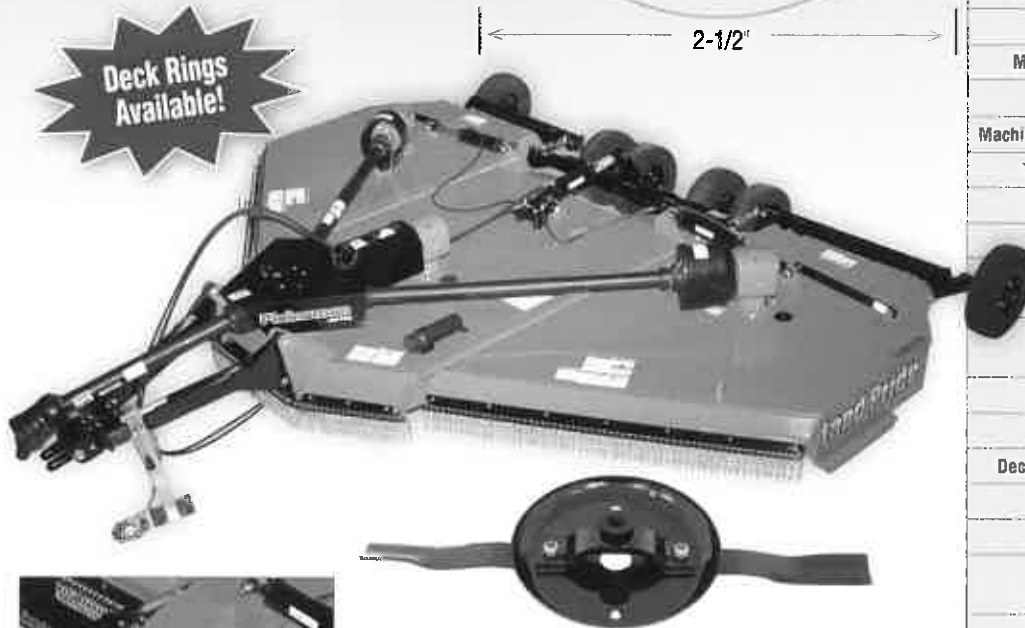

The 1" thick, 4" wide reinforcement aids the dishpan in withstanding the constant punishment the overall drivetrain must endure.

## Plainsman

The heavy-duty turnbuckle keeps the center and wing axles at the same cutting height. With grease fittings incorporated in the turnbuckle, free motion is maintained for quality performance.

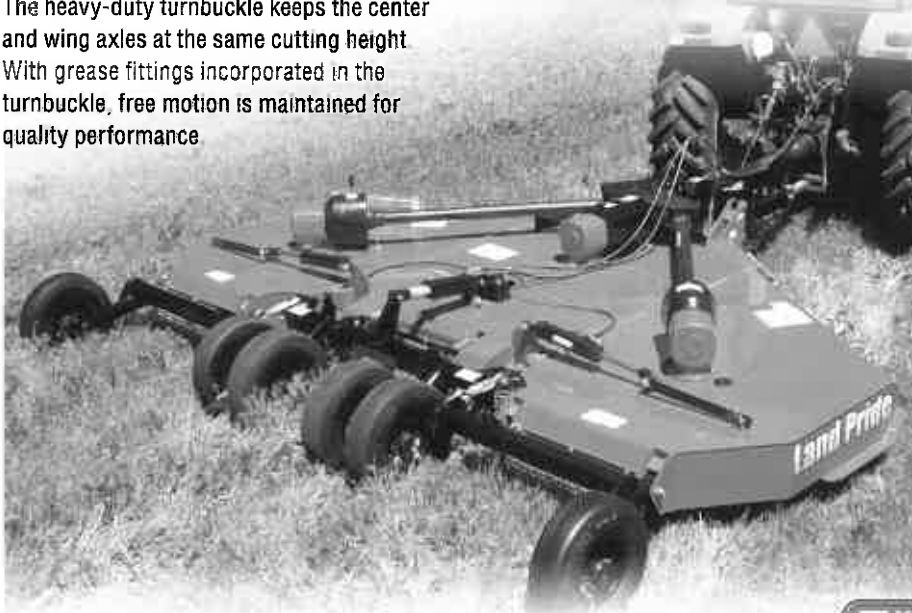

- 1" Solid and continuous hinge rods provide superior support from section to section
- Smooth top for easy clean off

RC3615 MEDIUM DUTY	
Horsepower	50-160 HP
Hitch	Pull-Type, Self-Leveling Hitch & Clevis
Working Width (cm)	15' (457)
Overall Width	15' 8"
Min. Transport Width	8'
Overall Length	15' 8"
Machine Weight - lb (kg)	3,730 (1692)
Tongue Weight - lb	1,240
Cutting Height	2" - 14"
Cutting Capacity	2-1/2"
Hitch	Standard Clevis, Swivel, or Bar-Tite Hitch
Height Adjustment	3" x 8" Cylinder, Hose, Fittings & Stroke Control Spacers
Deck Thickness	10 Gauge
Deck Height	12"
Deck Shock Protection	Spring Cushioned Center Axle
Deck Rings	Optional
Side Thickness	1/4"
Safety Guards (must choose)	Front & Rear: Single or Double Chain or Rubber
Skid Shoes	Wings and Center, Replaceable
Blades (2 per section)	1/2" x 4" Heat Treated Free Seizing Alloy Steel w/Uplift
Blade Bolt	Keyed with Hardened Flatwasher & Lock Nut
Blade Overlap	6"
Blade Tip Speed (Feet per minute)	540 RPM: 15,268 fpm on Center, 15,000 fpm on Wings 1000 RPM: 15,578 fpm on Center, 14,620 fpm on Wings
Dishpan	3/16" Round, Dish Shaped with 1" x 4" Blade Bar
Hydraulics	Wings: 2-1/2" x 12" Cylinder, Hoses & Fittings
Gearbox	540 or 1000 RPM: 160 HP Divider, 110 HP Center & Wings
Gearbox Output Shaft	2"
Gearbox Input Shaft	1-3/4" 20 Splines
Input Driveline	Cat. 6 CV or Cat. 5 Conventional
Connecting Drivelines	Cat. 4 with Slip-Clutch
Max. Turning Angle	80° w/Constant Velocity U-Joint
Tires - 4 or 6	21" Laminated 29" Used Aircraft 25 5" Foam-Filled

See dealer for complete warranty information.

**5 YEAR**  
Limited Lifetime  
Warranty

Color Options:



# RC4015 15' FOLDING ROTARY CUTTER

HP  
50-200

HITCH  
Pull-Type

## The Best of Both.

Combine the rugged, heavy-duty gearboxes from our RC5615 and the proven, dependable deck from our RC3615 and you get the new Land Pride RC4015. With a 3-1/2" cutting capacity and a blade tip speed of 16,300 fpm, the RC4015 is a solid medium-duty cutter in a long line of quality folding cutters from Land Pride.

# RANCHER

See a Video of the RC4015  
at [landpride.com](http://landpride.com)

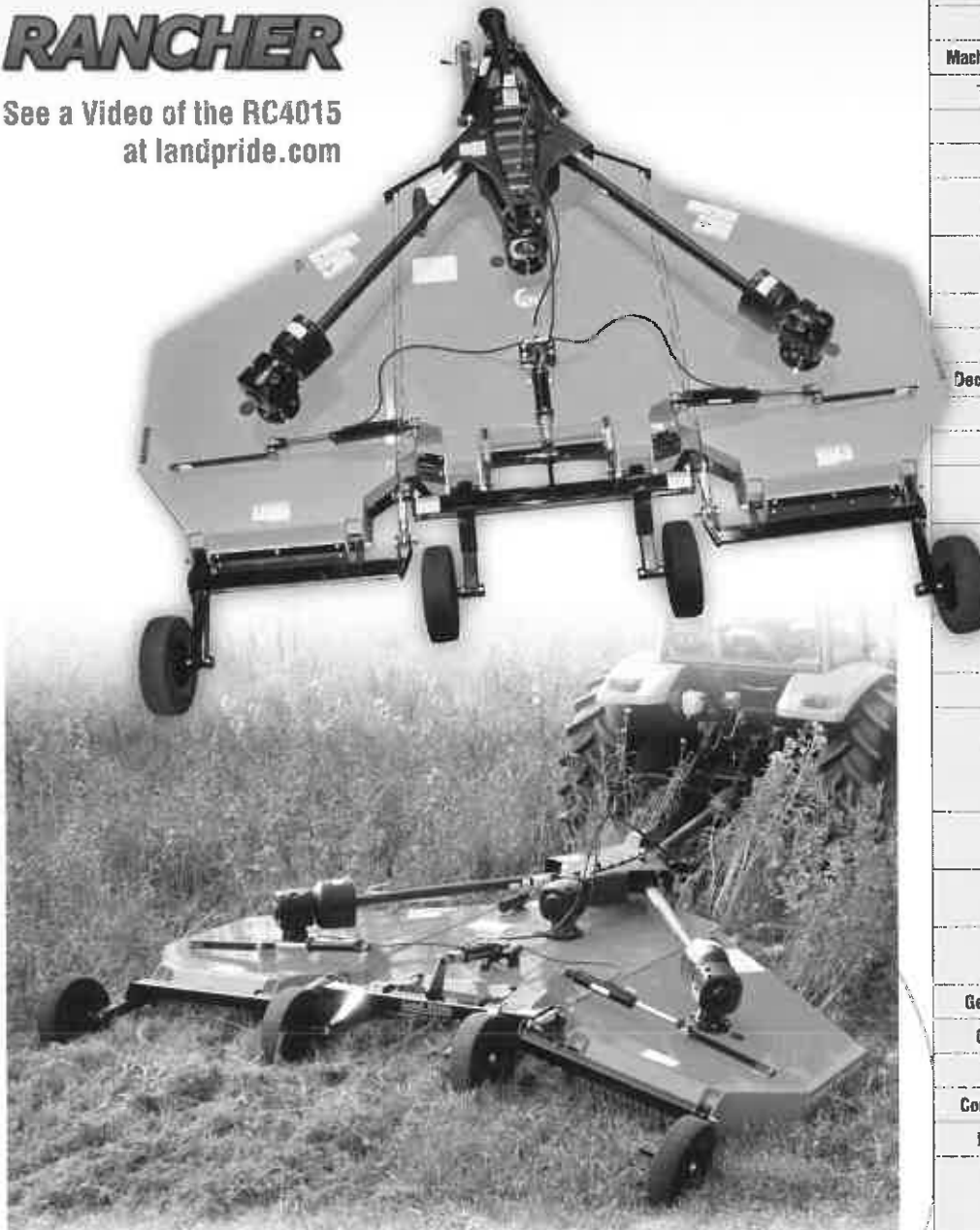

CUTTERS

	RC4015
<b>Horsepower</b>	50-200 HP
<b>Hitch</b>	Pull-Type, Self-Leveling Hitch & Clevis
<b>Working Width (cm)</b>	15' (457)
<b>Overall Width</b>	15' 9"
<b>Min. Transport Width</b>	8'
<b>Overall Length</b>	15' 6"
<b>Machine Weight - lb (kg)</b>	3,930 (1782)
<b>Tongue Weight - lb</b>	1,300
<b>Cutting Height</b>	2" - 14"
<b>Cutting Capacity</b>	3-1/2"
<b>Height Adjustment</b>	3" x 8" Cylinder, Hose, Fittings & Stroke Control Spacers
<b>Hitch</b>	Standard Clevis, Swivel, Ball, Pin, or Bar-Tite Hitch
<b>Deck Thickness</b>	10 Gauge
<b>Deck Height</b>	12"
<b>Deck Shock Protection</b>	Spring Cushioned Center Axle
<b>Deck Rings</b>	Optional
<b>Side Thickness</b>	1/4"
<b>Safety Guards (must choose)</b>	Front & Rear Single or Double Chain or Rubber
<b>Skid Shoes</b>	Wings and Center, Replaceable
<b>Blades (2 per section)</b>	1/2" x 4" Heat Treated Free Swinging Alloy Steel w/Uplift
<b>Blade Bolt</b>	Keyed with Hardened Flatwasher & Lock Nut
<b>Blade Overlap</b>	6"
<b>Blade Tip Speed (Feet per minute)</b>	540 RPM: 16,300 fpm on Center, 16,300 fpm on Wings 1000 RPM: 16,288 fpm on Center, 16,000 fpm on Wings
<b>Dishpan</b>	3/16" Round, Dish Shaped with 1" x 4" Blade Bar
<b>Hydraulics</b>	Wings 2-1/2" x 12" Cylinder, Hoses & Fittings
<b>Gearbox</b>	540 or 1000 RPM 250 HP Divider, 210 HP Center & Wings
<b>Gearbox Output Shaft</b>	2-3/8"
<b>Gearbox Input Shaft</b>	1-3/4" 20 Spline
<b>Input Briveline</b>	Cat 6 CV or Cat 5 Conventional
<b>Connecting Drivelines</b>	Cat 4 with Slip-Clutch
<b>Max. Turning Angle</b>	80° with Constant Velocity U-Joint
<b>Tires - 4 or 6</b>	21" Laminated 29" Used Aircraft 25 5" Foam-Filled

See dealer for complete warranty information.

3-1/2"  
CUTTING  
CAPACITY

7 YEAR  
Limited Lifetime  
Warranty

Color Options:

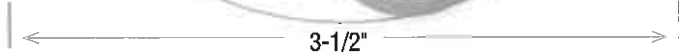

## Smooth top and bottom design.

Land Pride's 56 Series. 15 foot cutter is smooth on top, which allows debris and moisture to roll off or be easily swept or blown off. And its smooth on bottom, which means less chance of dry caking material getting lodged in tight corners, which again, means less time for cleaning.

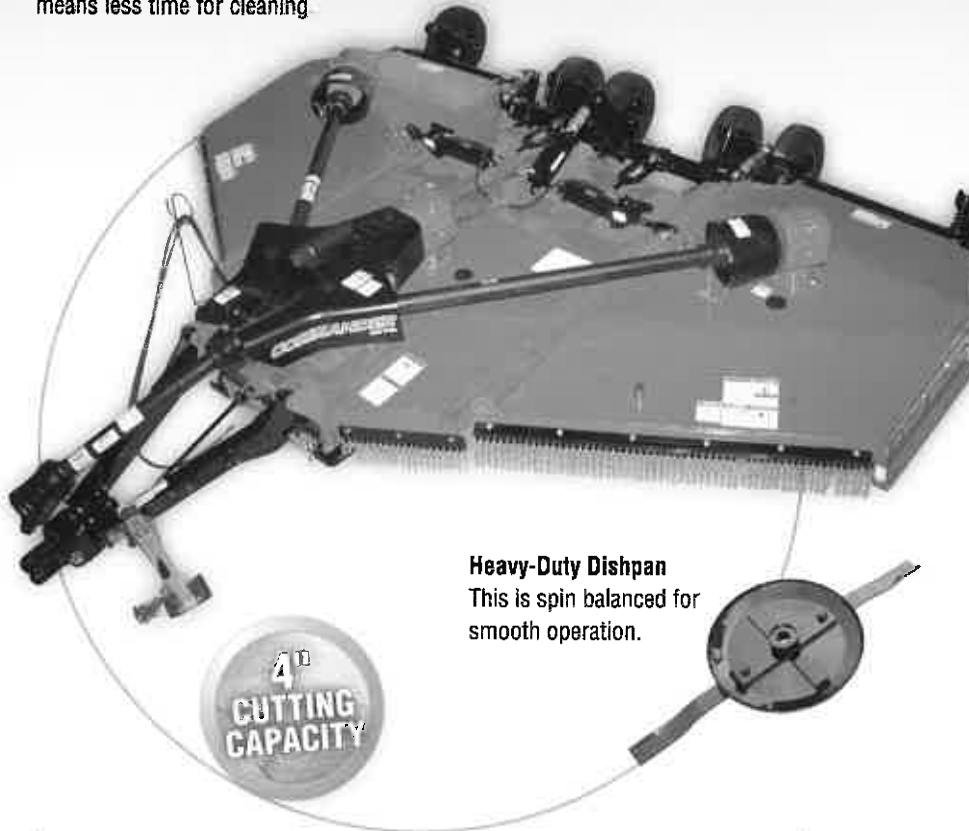

**Heavy-Duty Dishpan**  
This is spin balanced for smooth operation.

**4\"/>**

- 9' 1" Transport Width
- Smooth top and bottom design
- Replaceable 1/4" side skirts with replaceable skid shoes
- High blade tip speed



	RC5615 HEAVY DUTY
Horsepower	50-250 HP
Hitch	Pull-Type, Self-Leveling Hitch & Clevis
Working Width (cm)	15' (457)
Overall Width	15' 8"
Min. Transport Width	9' 1"
Overall Length	16'
Machine Weight - lb (kg)	5,446 (2470)
Cutting Height	2" - 14"
Cutting Capacity	4"
Hitch	Standard Clevis, Swivel, Ball, Pinite, or Bar-Tite Hitch
Tongue Weight - lb	2,080
Deck Thickness	7 Gauge Bottom, 10 Gauge Top
Deck Height	12"
Deck Shock Protection	Independent Wheel Arm Springs
Side Thickness	1/4" Replaceable
Safety Guards (must choose)	Front & Rear Single or Double Chain or Rubber Guard
Skid Shoes	Wings and Center, Replaceable
Blades	1/2" x 4" Heat Treated Free Swinging Alloy Steel w/Uplift
Blade Bolt	Keyed with Hardened Flatwasher & Lock Nut
Blade Overlap	6"
Blade Tip Speed (Feet per minute)	540 RPM: 16,300 fpm on Center, 16,300 fpm on Wings; 1000 RPM: 16,300 fpm on Center, 16,000 fpm on Wings
Dishpan	3/16", Round, Dish Shaped with 1" x 5" Blade Bar
Hydraulics	Wings: 3" x 8" Cylinder, Hoses and Fittings Axles: 3-1/2" x 8"
Gearbox	540 or 1000 RPM: 250 Center, 210 Wings
Gearbox Output Shaft	2-3/8"
Gearbox Input Shaft	1-3/4" 20 spline
Input Driveline	Cat. 6 CV or Cat. 5 Conventional
Connecting Drivelines	Choice of Cat. 4 or Cat. 5 Drivelines Slip-Clutch
Max. Turning Angle	80° with Constant Velocity U-Joint
Tires - 6 or 8	21" Laminated 23" Used Aircraft 25.5" Foam-Filled

See dealer for complete warranty information.

Color Options:





# RC6615 15' FOLDING ROTARY CUTTER

HP  
50-250

HITCH  
Pull-Type

## Nothing stands in our way!

The extra heavy-duty 66 Series Rotary Cutter has that extra muscle to cut in extreme conditions, and still give you the excellent appearance when completed. Cutting 4-1/2" material allows you to tackle a great deal of obstacles when cleaning up neglected pastures or fields.



4-1/2" CUTTING CAPACITY



Optional full welded deck rings keep blades from damaging the deck.

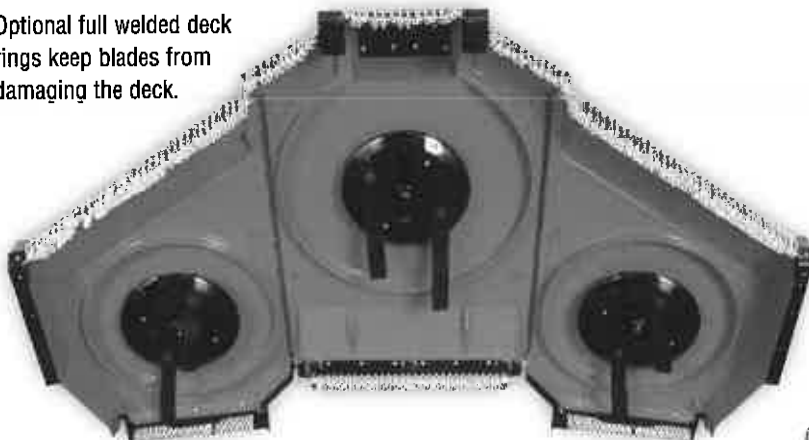

Land Pride strongly recommends that front and rear shielding be used with any Rotary Cutter. However, they can be purchased with or without shielding. Please understand how your cutter is to be equipped for you.

	RC6615 EXTRA HEAVY DUTY
Horsepower	50-250 HP
Hitch	Pull-Type, Self-Leveling Hitch & Clevis
Working Width (cm)	15' (457)
Overall Width	15' 8"
Min. Transport Width	9' 1"
Overall Length	16'
Machine Weight - lb (kg)	5,660 (2567)
Cutting Height	2" - 14"
Cutting Capacity	4-1/2"
Hitch	Standard Clevis, Swivel, Ball, Pintle, or Bar-Tite Hitch
Tongue Weight - lb	2,080
Deck Thickness	7 Gauge Bottom, 10 Gauge Top
Deck Height	12"
Deck Shock Protection	Independent Wheel Arm Springs
Deck Rings	Optional
Side Thickness	1/4" Replaceable
Safety Guards (must choose)	Front Single or Double Chain, Double Chain Guard w/Cable, or Rubber Guard Rear Single or Double Chain, Double Chain Guard w/Cable, or Rubber Guard
Skid Shoes	1 Each Wing, 2 on Center Section, Replaceable
Blades	1/2" x 4" Heat Treated Free Swinging Alloy Steel w/Uplift
Blade Bolt	Keyed with Hardened Flatwasher & Lock Nut
Blade Tip Speed (Feet per minute)	540 RPM, 16,300 fpm on Center, 16,300 fpm on Wings 1000 RPM, 16,300 fpm on Center, 16,000 fpm on Wings
Blade Overlap	6"
Dishpan	3/16" Round, Dish Shaped with 1" x 5" Blade Bar
Hydraulics	Wings 3" x 8" Cylinder, Hoses and Fittings Axle 3 5/8" x 8" Cylinder, Hoses, Fittings & Stroke Control Spacers
Gearbox	540 RPM or 1000 RPM, 250 HP Divider, 210 HP Center & Wings
Gearbox Output Shaft	2-3/8"
Gearbox Input Shaft	1-3/4" 20 Spline
Input Driveline	Cat 6 CV or Cat 5 Conventional
Connecting Drivelines	Star Shaped Cat 5 Slip-Clutch
Max. Turning Angle	80° with Constant Velocity U-Joint
Tires - 6 or 8	21" Laminated 29" Used Aircraft 25 5" Foam-Filled

See dealer for complete warranty information.

Color Options:

**7 YEAR**  
Limited Gearbox  
Warranty



CUTTERS

## Making roadside cutting safe and efficient.

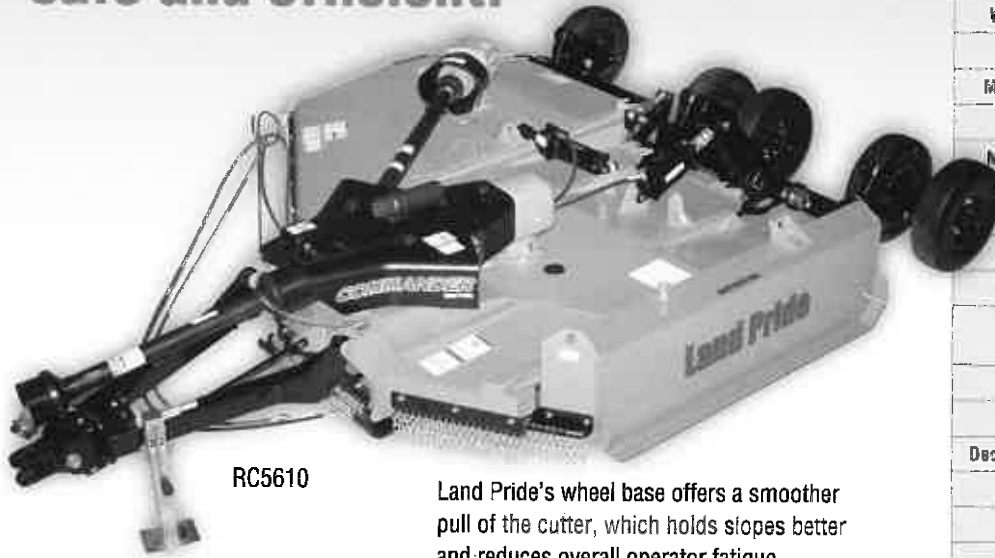

RC5610

Land Pride's wheel base offers a smoother pull of the cutter, which holds slopes better and reduces overall operator fatigue.



- Left hand weight box
- 5 or 6 Wheel option
- Optional hitch configurations
- Optional deck rings
- Replaceable 1/4" sideskirt with replaceable skid shoe

- Smooth top design
- Heavy-duty dishpans
- 4" Cutting capacity on RC56
- 4-1/2" Cutting capacity on RC66

Color Options: 



	RC5610, RC6610
<b>Horsepower</b>	50-250 HP
<b>Hitch</b>	Pull-type, Self-Leveling Clevis
<b>Working Width (cm)</b>	10' 6" (320)
<b>Overall Width</b>	11'7"
<b>Min. Transport Width</b>	7' 6-1/2"
<b>Overall Length</b>	16' 5"
<b>Machine Weight - lb (kg)</b>	RC56 & 66 5,292 (2400)
<b>Cutting Height</b>	2" - 14"
<b>Cutting Capacity</b>	RC56 4' RC66 4-1/2"
<b>Tongue Weight - lb</b>	1,860
<b>Hitch</b>	Standard Clevis, Skidrol, Ball, Pintle, or Bar-Tite Hitch
<b>Deck Thickness</b>	7 Gauge Bottom, 10 Gauge Top
<b>Deck Height</b>	12"
<b>Deck Shock Protection</b>	Independent Wheel Arm Springs
<b>Deck Rings</b>	Optional
<b>Side Thickness</b>	1/4" Replaceable
<b>Skid Shoes</b>	1 Each Wing, 2 on Center Section. Replaceable
<b>Safety Guards (must choose)</b>	Front: Single or Double Chain, Double Chain with Cable, or Rubber Guard Rear: Single or Double Chain, Double Chain with Cable, or Rubber Guard
<b>Blades</b>	1/2" x 4" Heat Treated Free Swinging Alloy Steel w/Uplift
<b>Blade Bolt</b>	Keyed with Hardened Flatwasher & Lock Nut
<b>Blade Tip Speed (Feet per minute)</b>	540 RPM; 16,300 fpm on Center, 16,300 fpm on Wings 1000 RPM; 16,300 fpm on Center, 16,000 fpm on Wings
<b>Blade Overlap</b>	6"
<b>Dishpan</b>	3/16" Round, Dish Shaped with 1" x 5" Blade Bar
<b>Hydraulics</b>	RC56 & 66: Wings 3" x 12" RC56 & 66: Wings 3" x 8" Cylinder, Hoses and Fittings & Axle 3.5" x 8" Cylinder, Hoses, Fittings, & Stroke Control Spacers
<b>Gearbox</b>	540 RPM or 1000 RPM 250 HP Divider, 210 HP Center & Wings
<b>Gearbox Output Shaft</b>	2-3/8"
<b>Gearbox Input Shaft</b>	1-3/4" 20 Spline
<b>Input Driveline</b>	Cat. 6 CV or Cat. 5 Conventional
<b>Connecting Drivelines</b>	Cat. 4 or 5 with 5 Slip-Clutch
<b>Max. Turning Angle</b>	80° with Constant Velocity U-Joint
<b>Tires - 5 or 6</b>	21" Laminated 29" Used Aircraft 25 5" Foam-Filled

## Plainsman



Land Pride's RC3620 is the ideal Rotary Cutter for grassy fields, pastures, waterways, buffer strips, and set-aside acres and handles saplings up to 2" in diameter. With tips speeds of 16,000 to 16,500, gearboxes rated at 250 HP and 130 HP, 1-3/4" input shafts and 2" output shafts, and optional CV drivelines, this unit will make quick and efficient work of the largest jobs.



2" CUTTING CAPACITY

Also available as a 14' offset model: RC3614.

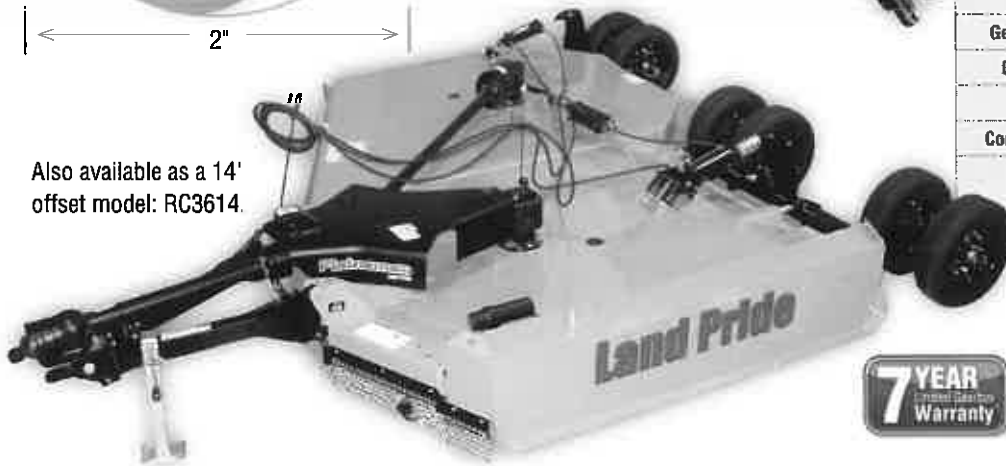

	RC3614	RC3620
Horsepower	70-160 HP	
Hitch	Pull-Type	
Working Width (cm)	14' (426)	20' (607)
Overall Width	15'	20' 10"
Min. Transport Width	8' 9"	9' 11"
Overall Length	17' 6" with Laminated Tires	
Machine Weight - lb (kg)	5,990 (2717)	6,280 (2849)
Cutting Height	2" - 12"	
Cutting Capacity	2" Diameter	
Hitch	Standard Clevis, Swivel, Ball, Pintle, or Bar-Tite Hitch	
Tongue Weight - lb	2,220	1,750
Max. Turning Angle	80° with Constant Velocity U-Joint	
Deck Height	13"	
Deck Thickness	10 Gauge	
Deck Shock Protection	Spring Cushioned Axle	
Deck Rings	Optional	
Side Thickness	1/4"	
Safety Guards (must choose)	Front & Rear Single or Double Chain	
Skid Shoes	1 Each Wing, 2 on Center Section, Replaceable	
Blades	1/2" x 4" High Lift	
Blade Belt	Keyed with Hardened Flatwasher & Lock Nut	
Blade Tip Speed (Feet per minute)	540 RPM: 16,000 fpm on Center, 16,000 fpm on Wings 1000 RPM: 16,500 fpm on Center, 16,500 fpm on Wings	
Blade Overlap	6"	
Dishpan	10 Gauge Round Dish Shaped w/ 1" x 4-1/2" Blade Bar	
Hydraulics	Wings 3" x 12" Cylinder, Hoses and Fittings Axle Center-2-3/4" x 8" Cylinder RH Wing-3" x 8", LH Wing-3-1/4" x 8" Hoses, Fittings and Stroke Control Spacers	
Gearbox	540 RPM or 1000 RPM 250 HP Splitter, 130 HP Wings & Ctr	
Gearbox Output Shaft	2"	
Gearbox Input Shaft	1-3/4" 20 Spline	
Input Driveline	Cat 6 CV or Cat 5 Conventional	
Connecting Drivelines	4-Plate Slip Clutch, Cat 4	
Tires	21" Laminated RC3614: 5, 6 or 8 RC3620: 6 or 8 29" Used Aircraft 27" Foam-Filled	

See dealer for complete warranty information.

Color Options:

**7 YEAR**  
Extended Limited  
Warranty





## 14' - Largest offset cutter in the family!



A 14' swath on a roadside can knock out a lot of work in one pass. Equipped with extra heavy-duty gearboxes and drivelines, and a dish pan to help protect it all, this cutter is ready to go to work!

### Commander

- Heavy-duty stump jumper
- Left side weight box



Choice of used aircraft tires w/wo foam or laminated tires.



3'

#### Hitches Available on all 36 Series and above Folding Cutters



**Standard Clevis Hitch**  
Pivots up and down for uneven terrain



**Double Swivel Clevis Hitch**  
Swivels up and down and side to side



**Bar-tite™ Clevis Hitch**  
Bolts tight to drawbar which eliminates drawbar wear. Swivels up and down, and rotates on greasable shaft

	RC5014
Horsepower	70-250 HP
Hitch	Pull-Type, Self-Leveling Clevis
Working Width (cm)	13' 6"
Overall Width	14' 7"
Min. Transport Width	8' 9"
Overall Length	19' 3" w/Laminated Tires
Machine Weight - lb (kg)	7,282 (3303)
Cutting Height	2" - 14"
Cutting Capacity	3" Diameter
Tongue Weight - lb	2,300
Hitch	Standard Clevis, Swivel, Ball, Pintle, or Bar-Tite Hitch
Deck Thickness	3/16"
Deck Height	10-1/2"
Deck Shock Protection	Spring Cushioned Axle
Deck Rings	Optional
Side Thickness	1/4"
Safety Guards (most choose)	Single or Double Chain or Rubber
Skid Shoes	1 on Wing and Weight Box, 2 on Center Section, Replaceable
Blades	1/2" x 4" High Lift
Blade Bolt	Keyed with Hardened Flatwasher & Lock Nut
Blade Tip Speed (Feet per minute)	540 RPM: 17,377 fpm on Center, 17,329 fpm on Wings 1000 RPM: 18,165 fpm on Center, 18,317 fpm on Wings
Blade Overlap	5"
Dishpan	3/16" Round, Dish Shaped w/1" Steel Plate Support
Hydraulics	Wings: 3-1/2" x 8" Cylinder, Hoses and Fittings Axle: 4" x 8" Cylinder, Hoses, Fittings and Stroke Control Spacers
Gearbox	540 RPM or 1000 RPM, 250 HP Divider, 210 HP Center & Wing
Gearbox Output Shaft	2-3/8"
Gearbox Input Shaft	1-3/4" 20 Spline
Input Driveline	Cat. 6 CV or Cat. 5 Conventional
Connecting Drivelines	Slip Clutch, Cat. 5
Max. Turning Angle	80° with Constant Velocity U-Joint
Tires - 5 or 6	21" Laminated 29" Used Aircraft 27" Foam-Filled

See dealer for complete warranty information.

Color Options:



# RC5020 20' FOLDING ROTARY CUTTER

HP  
70-250

HITCH  
Pull-Type

## Be More Productive, 20' at a Time.

Roadsides, pastures, set-aside acres and crop residue are perfect jobs for the 20' Commander. Wing decks float independently, and follow the contour of the land leaving a nicely cut surface.



The 20' cutting width, 2" to 14" cutting height and ability to cut weeds and brush up to 3" in diameter make the RC5020 well suited for varied applications. Various safety guard choices make these an excellent choice for state and municipal mowing applications.

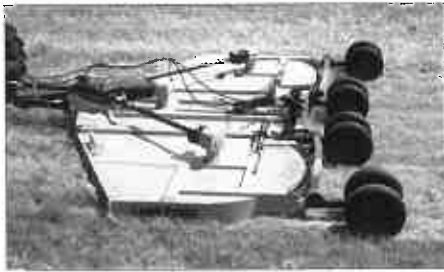

Outer wing wheels can be single or dual. Duals are ideal when mowing in areas where one wing needs to flex uphill. The outer wheel rides up the embankment and keeps the deck from gouging. Wheel spindles are bolt-in to allow easy change out.

3" CUTTING CAPACITY

3"

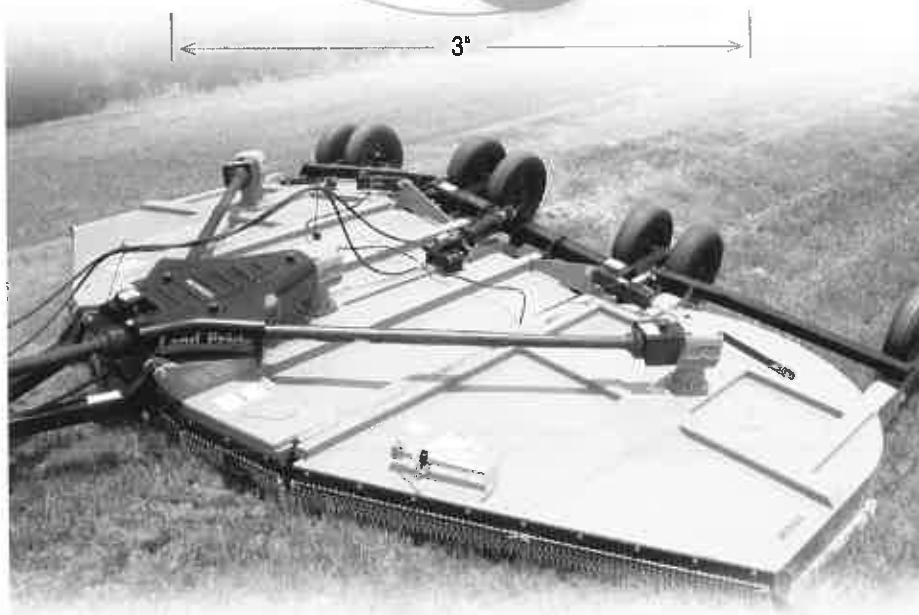

# Commander

	RC5020 HEAVY DUTY
Horsepower	70-250 HP
Hitch	Pull-Type
Working Width (cm)	20' (607)
Overall Width	20' 9-1/2"
Min. Transport Width	8' 9"
Overall Length	19' 3" with Laminated Tires
Machine Weight - lb (kg)	6 528 (2961)
Cutting Height	2" - 14"
Cutting Capacity	3" Diameter
Hitch	Standard Clevis, Swivel, Ball, Pintle, or Bar-Tite Hitch
Tongue Weight - lb	2,300
Maximum Turning Angle	80° with Constant Velocity U-Joint
Deck Thickness	3/16"
Deck Height	10-1/2"
Deck Shock Protection	Spring Cushioned Axle
Deck Rings	Optional
Side Thickness	1/4"
Safety Guards (must choose)	Front and Rear: Single or Double Chain or Rubber
Skid Shoes	Reversible, 1 each wing, 2 on center section, replaceable
Blades	1/2" x 4" High Lift
Blade Bolt	Keyed with Hardened Flatwasher & Lock Nut
Blade Tip Speed (Feet per minute)	540 RPM, 17,377 fpm on Center, 17,329 fpm on Wings 1000 RPM, 18,165 fpm on Center, 18,317 fpm on Wings
Blade Overlap	6"
Dishpan	3/16" Round, Dish Shaped w/ 1" Steel Plate Support
Baffle Kit	Optional - Rear
Hydraulics	Wings: 3-1/2" x 12" Cylinder, Hoses and Fittings Axle: 4" x 8" Cylinder, Hoses, Fittings and Stroke Control Spacers
Gearbox	540 RPM or 1000 RPM, 250 HP Divider, 210 HP Center & Wings
Gearbox Output Shaft	2-3/8"
Gearbox Input Shaft	1-3/4" 20 Spline
Input Driveline	Cat 6 CV or Cat 5 Conventional
Connecting Drivelines	4-Plate Slip Clutch, Cat 5
Tires 6 or 8	21" Laminated 29" Used Aircraft 27" Foam-Filled

See dealer for complete warranty information.

Color Options: 

**7 YEAR**  
Limited Gearbox  
Warranty



CUTTERS

## Go all in with your next bid!



# DOMINATOR

All of the features found on our RC66 Series Rotary Cutter and more!

**4-1/2" CUTTING CAPACITY**



**Extra Heavy-Duty Dishpan**  
Our 1" thick plate adds superior strength to our dishpan.

4-1/2"

Our RCB66 Series Rotary Cutters offer many of the additional features that counties, states, and contract cutters are looking for.

- 4-1/2" Cutting capacity
- 7 Gauge bottom, 10 gauge top
- 12" Deck height
- Extra heavy-duty gearboxes with 2-3/8" output shafts
- Spring cushioned axle
- Optional deck rings
- Optional tool box\*
- Rephasing cylinders on wing axles for levelling the wings
- Optional walking tandem axles on center and wings for a smoother pull
- Independent wing hydraulics
- Cable winch (optional) for raising or lowering the wings in a hydraulic failure
- Wing skid shoe: AR400 steel\*
- SMV Sign\*

RCB6615 EXTRA HEAVY DUTY	
Horsepower	50-250 HP
Hitch	Pull-Type, Self-Leveling Hitch & Clevis
Working Width (cm)	15' (457)
Overall Width	15' 8"
Min. Transport Width	9'1"
Overall Length	17' 1"
Machine Weight - lb (kg)	5 738 (2603)
Caking Height	2' - 14'
Cutting Capacity	4-1/2"
Hitch	Standard Clevis, Swivel, Ball, Pintle, or Bar-Tite Hitch
Tongue Weight - lb	1,842
Deck Thickness	7 Gauge Bottom, 10 Gauge Top
Deck Height	12"
Deck Shock Protection	Spring Cushioned Axle
Deck Rings	Optional
Side Thickness	1/4" Replaceable
Safety Guards (must choose)	Front: Single or Double Chain, Dbl Chain w/Cable, or Rubber Guard Rear: Single or Double Chain, Dbl Chain w/Cable, or Rubber Guard
Skid Shoes	2 Each Wing, 2 on Center Section, Replaceable
Blades	1/2' x 4" Heat Treated Free Swinging Alloy Steel w/Uplift
Blade Bolt	Keyed with Hardened Flatwasher & Lock Nut
Blade Tip Speed (Feet per minute)	540 RPM: 16,300 fpm on Center, 16,300 fpm on Wings 1000 RPM: 16,300 fpm on Center, 16,000 fpm on Wings
Blade Overlap	6"
Dishpan	3/16" Round, Dish Shaped with 1" Steel Plate Support
Hydraulics	6' Wings: 3-1/2" x 8" Cylinder Axle: Center-3-1/2" x 8" Cylinder RH Wing-3-1/4" x 8", LH Wing-3" x 8"
Gearbox	540 RPM or 1000 RPM; 260 HP Divider, 210 HP Center & Wings
Gearbox Output Shaft	2-3/8"
Gearbox Input Shaft	1-3/4" 20 Spline
Input Driveline	Cat. 6 CV or Cat. 5 Conventional
Connecting Drivelines	Cat. 5 Slip-Clutch
Max. Turning Angle	80° with Constant Velocity U-Joint
Tires - 6 or 8	21" Laminated 29" Used Aircraft 25.5" Foam-Filled

See dealer for complete warranty information.

Color Options:



## Versatility to fit every need.

Our 05 Series Reverse Tine Rotary Tillers are perfect for the popular subcompact tractors. If you are tilling your yard for reseeding, or getting the garden ready for spring planting, turn your ground over efficiently with the best small tiller available!



- Cast iron bearing mounts
- Adjustable rear deflector
- Front rubber flap to keep dirt in
- Lower hitch clevises for easier hook up to tractor

	RTR0512	RTR0550
<b>Horsepower</b>	Up to 25 HP	
<b>Hitch</b>	Cat. 0, Cat. 1, Cat. 1 Ltd	
<b>Width-endplate to endplate (cm)</b>	42" (107)	50" (127)
<b>Overall width</b>	46-1/2" (118)	54-1/2" (139)
<b>Weight - lb (kg)</b>	268 (122)	298 (135)
<b>Number of Flanges</b>	5	6
<b>No. of Blades per Flange</b>	4 C-Shape	
<b>Blade Spacing</b>	7-7/8"	6-3/4"
<b>Max. Tilling Depth</b>	6-1/2"	
<b>Skid Shoe Settings</b>	4	
<b>Rotor Swing Diameter</b>	13"	
<b>Rotor Shaft Speed</b>	230 rpm at 540 rpm PTO	
<b>PTO Driveline</b>	ASAE Category 2 Off-Center Shear Bolt or Slip Clutch	
<b>Gearbox</b>	25 HP, 540 rpm, Cast Iron Housing, Drain Plug	
<b>Drive Chain</b>	#80 High Tensile in Oil Bath	
<b>Sprockets</b>	Hardened Teeth, Splined Center	

See dealer for complete warranty information.

Tilling depth depends on conditions and fluffiness of tilled area.

Color Options:



## The most popular Rotary Tiller for compact tractors!

The Land Pride RTA12 Series Forward-Till and RTR12 Series Reverse-Till Rotary Tillers are a great seedbed preparation tool for either general gardening or lawn/landscape seeding. With uses in many residential applications. Land Pride 12 Series Rotary Tillers offer an economical yet durable tilling solution. These units feature a 3 year gearbox warranty, 42", 50", 58", 66", & 74" working widths, and 6-1/2" tilling depth.



- Offset capabilities
- Forward or Reverse models available
- Lower clevis hitch for easier hook-up
- Steel plate upper hitch

	RTA1242 RTR1242	RTA1250 RTR1250	RTA1258 RTR1258	RTA1266 RTR1266	RTA1274 RTR1274
Horsepower	15-35 HP		20-40 HP		25-50 HP
Hitch	Cat. 1				
Width-Endplate to Endplate (cm)	42" (107)	50" (127)	58" (147)	66" (168)	74" (188)
Overall Width	RTA 47-3/8" RTR 48-1/4"	RTA 55-3/8" RTR 56-1/4"	RTA 63-3/8" RTR 64-1/4"	RTA 71-3/8" RTR 72-1/4"	RTA 79-3/8" RTR 80-1/4"
Weight - lb (kg)	RTA 391 (177) RTR 404 (183)	RTA 421 (191) RTR 435 (197)	RTA 448 (203) RTR 463 (210)	RTA 476 (216) RTR 493 (224)	RTA 503 (228) RTR 521 (236)
Number of Flanges	5	6	7	8	9
No. of Blades per Flange	4 C-Shape				
Blade Spacing	7-7/8"				
Max. Tilling Depth	6-1/2"				
Skid Shoe Settings	7				
Rotor Swing Diameter	18"				
Rotor Shaft Speed	211 rpm at 540 rpm PTO				
PTO Driveline	Category 2 Slip Clutch				
Gearbox	50 HP, 540 rpm, Cast Iron Housing, Drain Plug				
Drive Chain	#80 High Tensile in Oil Bath				
Sprockets	Hardened Teeth, Splined Center				

See dealer for complete warranty information

Color Options:





## Sized right for hobby farms and nurseries.

The 15 Series Land Pride Rotary Tiller is sized just right for compact tractors that are used on hobby farms and in nurseries in every corner of the country.

The sideshift feature on the 15 Series Rotary Tillers enables you to shift the tiller to the right to cover a tire track or get closer to obstacles, while allowing the driveline to remain straight.

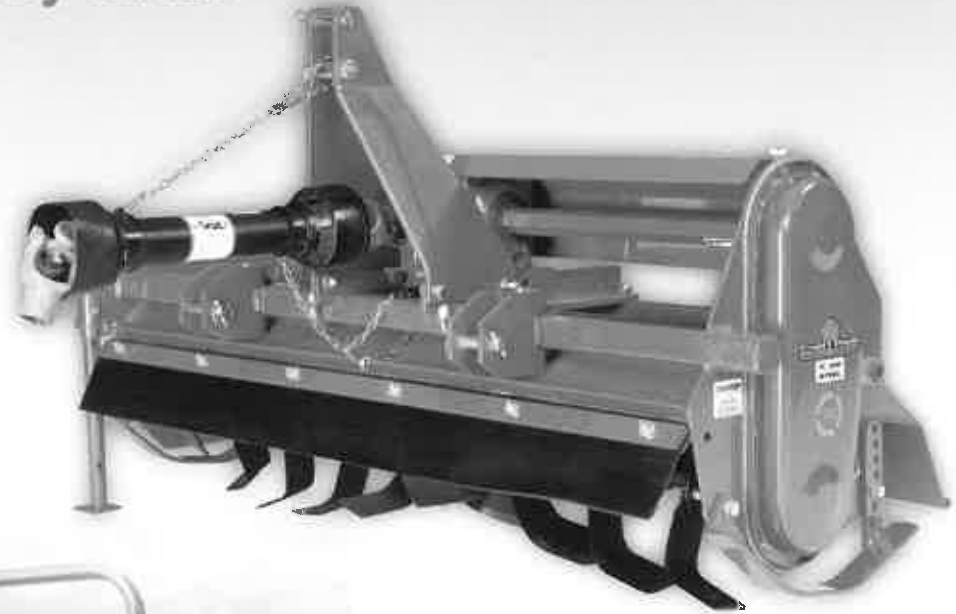

	RTR1550	RTA1563 RTR1565	RTA1566 RTR1568	RTR1571 RTR1573
<b>Horsepower</b>	17-50 HP			
<b>Hitch</b>	Cat. 1			
<b>Width-Endplate to Endplate (cm)</b>	50" (127)	58" (147)	66" (168)	74" (188)
<b>Overall Width</b>	56-1/4"	64-1/4"	72-1/4"	80-1/4"
<b>Weight - lb (kg)</b>	455 (206)	489 (222)	523 (237)	557 (253)
<b>Number of Flanges</b>	6	7	8	9
<b>No. of Blades per Flange</b>	4 C-Shape			
<b>Blade Spacing</b>	7-7/8"			
<b>Max. Tilling Depth</b>	6-1/2"			
<b>Skid Shoe Settings</b>	7			
<b>Rotor Swing Diameter</b>	15"			
<b>Rotor Shaft Speed</b>	211 rpm at 540 rpm PTO			
<b>PTO Driveline</b>	ASAE Category 3, Off-Center Shear Bolt or Slip Clutch			
<b>Gearbox</b>	50 HP, 540 rpm, Cast Iron Housing, Drain Plug			
<b>Drive Chain</b>	#80 High Tensile in Oil Bath			
<b>Sprockets</b>	Hardened Teeth, Splined Center			

See dealer for complete warranty information.  
See page 46 for reverse-till diagram.

Color Options:  



## We have traditional Forward Rotation...

Available in two popular widths, the Land Pride RTA20 Series Rotary Tiller effortlessly turns up hard-packed ground, leaving a perfect seedbed for gardens or grass. Suited for up to 50 HP tractors, this model fits a wide range of tractor owners, from landscapers or city and park maintenance operations to golf course superintendents.

The Land Pride RTR20 Series Rotary Tillers are just right for home gardening, landscape work, food plot maintenance, and light commercial use. Available in 64" and 72" widths, RTR20 Series Rotary Tillers feature a reverse tilling action for tough ground conditions. The reverse action of the rotor brings material up and over the top, burying heavier clods and small rocks, leaving the fines on top for a perfect seed bed.

Both models use standard Land Pride features like a stamped chain cover, adjustable rear deflector, heavy-duty driveline and parking stand – in the end the quality and dependability shine through.

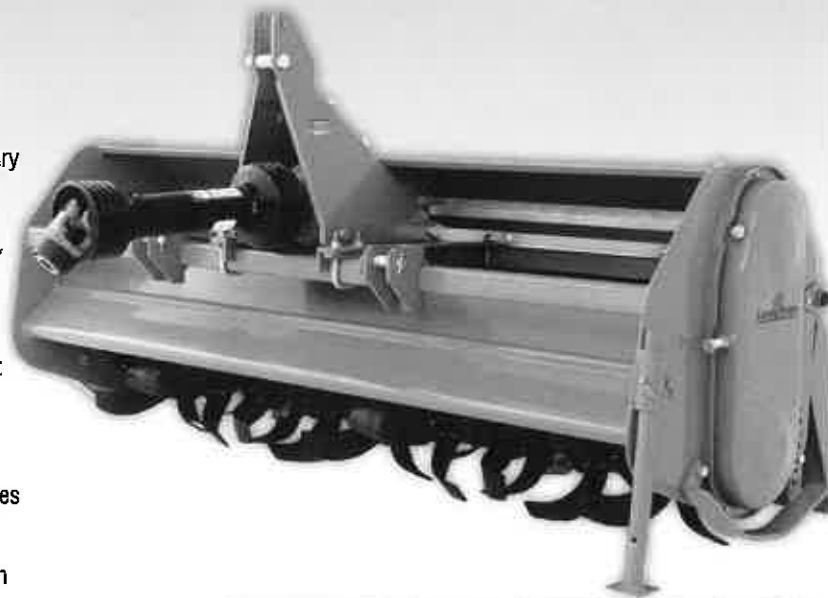

## And the most popular Reverse Rotation...



	RTA2064	RTA2072	RTR2064	RTR2072
Horsepower	23-50 HP			
Hitch	Cat 1			
Width-Endplate to Endplate (cm)	64" (162)	72" (183)	64" (162)	72" (183)
Overall Width	70-13/16"	77-7/8"	70-13/16"	77-7/8"
Weight - lb (kg)	689 (313)	734 (333)	748 (339)	795 (361)
Number of Flanges	8	9	8	9
No. of Blades per Flange	6 C-Shape			
Blade Spacing	7-1/2"			
Max. Tilling Depth	7"			
Skid Shoe Settings	7"			
Offset	14"	18"	14"	18"
Number of Sifting Tines	N/A		43	48
Rotor Swing Diameter	17"			
Rotor Shaft Speed	220 rpm at 540 rpm PTO			
PTD Driveline	ASAE Category 3, Heavy Duty Shear Bolt or Slip Clutch			
Gearbox	50 HP 540 rpm, Cast Iron Housing, Drain Plug			
Drive Chain	#80 High Tensile in Oil Bath			
Sprockets	Hardened Teeth, Splined Center			

See dealer for complete warranty information.  
Tilling depth depends on conditions and fluffiness of tilled area.  
See page 46 for reverse-till diagram.

Color Options:





## A contractor's dream.

Ideal for landscapers and gardeners, the Land Pride RTA25 Series Rotary Tillers prepare seedbeds for gardening or lawn planting. Rugged and dependable, the RTA25 features a heavy-duty driveline, a parking stand for easy hook-up, and optional down pressure springs apply pressure on the rear deflector, holding larger debris in the tines for better pulverization in tough leveling conditions.



	RTA2502	RTA2570	RTA3578
Horsepower	25-55 HP		35-75 HP
Hitch	Cat. 1		Cat. 1
Width-Endplate to Endplate (cm)	64" (162)	70" (178)	76" (193)
Overall Width	68"	76"	81-1/2"
Weight - lb (kg)	649 (294)	663 (301)	856 (388)
Number of Flanges	8	9	8
No. of Blades per Flange	6 C-Shape		6 C-Shape
Blade Spacing	7-7/8"		9"
Max. Tilling Depth	7"		7"
Skid Shoe Settings	6		6
Rotor Swing Dia.	17"		19"
Rotor Shaft Speed	220 rpm at 540 rpm PTO		204 rpm at 540 rpm PTO
PTO Driveline	ASAE Category 3 Heavy Duty Shear Bolt or Slip Clutch		ASAE Category 4 Slip Clutch
Gearbox	55 HP, 540 rpm, Cast Iron Housing, Drain Plug		75 HP 540 rpm, Cast Iron Housing, Drain Plug
Drive Chain	#100 High Tensile in Oil Bath		#100 High Tensile in Oil Bath
Sprockets	Hardened Teeth, Splined Center		Hardened Teeth, Splined Center

TILLERS

See dealer for complete warranty information.  
Tilling depth depends on conditions & fluffiness of tilled area.

Color Options:



## RTA35 SERIES: Ready to tackle the tough stuff.

The RTA35 Series is Land Pride's toughest tiller, built to withstand the rigors of commercial jobs. The 35 Series Tiller is designed to go all day, day after day, in the most demanding jobs. With a 19" rotor swing diameter, this tiller can turn over a bunch of dirt without much getting in its way and is ideal for landscaping, nurseries, and commercial gardening applications.



### Adjustable Lower Hitch

With a 76" working width, and adjustable lower hitch clevises, taking out your tire track is usually achievable. This allows for less overlap needed, meaning less time in the tractor seat.



## Save time with reverse rotation.

Ground cover in your way? No problem for a Reverse Tine Tiller. It turns it up, chops it a time or two, and buries it under a cascade of large clods, which are buried under small clods. Large clods fall first, and they just get smaller as they pile on top of each other. What's left on top is a perfect seedbed to foster your wild imagination!



Sifting tines help "sift" the tilled material. Large or clumpy material fall first, with the top layer being a perfect consistency for planting.



Rear deflector removed for photo.

- Spring-loaded rear deflector levels the freshly tilled seedbed
- Hinged front flap with rubber insert helps prevent damage to deck from debris coming over the top of the tines
- Skid shoe on drive side has additional chain case protection

	RTR2570
Horsepower	25-55 HP
Hitch	Cat. 1
Width-Endplate to Endplate (cm)	70" (178)
Overall Width	76" (193)
Weight - lb (kg)	888 (394)
Number of Flanges	8
No. of Blades Per Flange	6 C-Shape
Blade Spacing	7-7/8"
Max. Tilling Depth	7"
Skid Shoe Settings	7
Offset	Up to 5"
Number of Sifting Tines	46
Rotor Swing Diameter	17"
Rotor Shaft Speed	220 rpm at 540 rpm PTO
PTO Driveline	ASAE Category 3 Slip Clutch
Gearbox	55 HP, 540 rpm, Cast Iron Housing, Drain Plug
Drive Chain	#100 High Tensile in Oil Bath
Sprockets	Hardened Teeth, Splined Center

See dealer for complete warranty information. Tilling depth depends on conditions & fluffiness of tilled area.

Color Options:



The reverse rotation of the tiller tines forces the tiller in the ground, preventing "walking" on hard ground. Once it's in, it stays put!

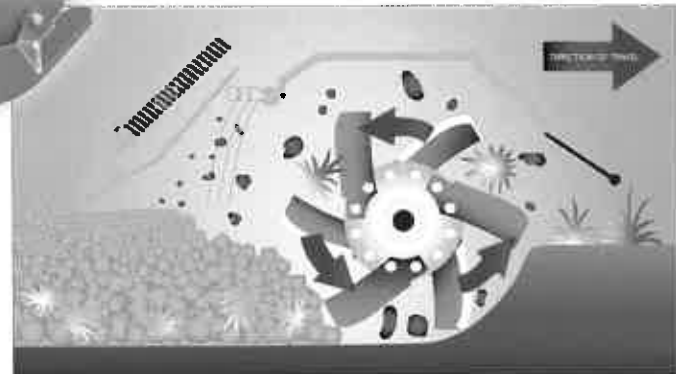

## The seeder that does it all.

While seeding into a freshly prepared site, the front angling rollers help cut through the top crust, kicking up a light amount of soil, making sure the ground is soft. The seed is then dropped and compressed by the rear roller. Establishing this initial seed to soil contact is essential in achieving a high rate of germination.



### The many uses for the APS:

- Bare dirt seeding
- Turf overseeding
- Wildlife Conservation Seeding

### OVERSEEDING OR NEW SEEDING

The All-Purpose Seeder is ground driven with no driveline and related drivetrain components to maintain. By adjusting the front two rollers, you can control how aggressive you want to be in the area you are seeding or overseeding.

Optional small seeds box.



### Rear Rollers

Choose between a rear spiked roller or a 12" cast packer wheel roller.

	APS1543	APS1560	APS1572	APS1586
Horsepower	25-80 HP			
Hitch	Cat. 1			Cat. 1 & 2
Working Width (cm)	50" (127)	60" (152)	72" (183)	86" (218)
Overall Width	60"	72"	81"	98"
Overall Length	49"	51"	52"	55-1/2"
Overall Height	42-1/2"			
Weight - lb (kg)	547 (248)	702 (318)	836 (379)	1070 (485)
Seedbox Capacity	4	5	6	7.2 Bushel
Output Range	Varies By Seed Variety, Consult Manual			
Front Roller - 2	8" Diameter, 1" Spindles w/Greaseable Ball Bearings			
Rear Roller	8" Diameter w/Studs or 12" Cast Packer Wheels			
Chain	#40 with Spring Loaded Idler			
Seed Cups	7	8	10	12
Front Roller Angling	Up to 20°			
Roller Studs	1/2" to 2" Heat Treated Steel, Replaceable			

\*60" and 86" models with rear cast packer wheels

Color Options:



## Renovate turf or establish a new lawn with an OS15.



The optional small seeds box allows two seeds to be metered at one time into the same seed tube for even distribution.

	OS1548	OS1572
Horsepower	25-60 HP	30-60 HP
Hitch	Cat. 1	
Working Width (broadcast) (cm)	51" (129)	72" (183)
Overall Width (w/gauge wheels)	77-3/4"	99"
Overall Width (w/rear roller drive)	69-1/8"	81-1/4"
Overall Length	52-7/16"	
Weight - lb (kg) (gauge whl drive)	1290 (585)	1645 (746)
Knives - 5 per flange	Standard or Curved 115 on 2"; 80 on 3" Standard or Curved 170 on 2"; 115 on 3"	
Roller	18" Diameter	
Productivity (3-1/2 mph)	1.5 Acres/hr (broadcast) 2 Acres/hr (broadcast)	
Depth Adjustment	0" - 1-1/2"	
Blade Spacing	2" or 3"	
Gearbox	540 RPM Cast Iron Housing	
Seedbox	4 or 6 Bushel, Paddle Agitator	
Small Seedbox Capacity	95 or 136 Bushel	
Seed Cups & Drive	7 or 10 Seed Cups; Powder Metal Flutes with Individual Cleanout Handles. RH Gauge Wheel Drive or Rear Roller Drive	
Packer Wheels	12" Cast Iron with Corrugated Scraper	
Roller Chain	#80 or #100, Adjustable, Fully Enclosed in Oil Bath	
Driveline	Fully Shielded, Heavy-Duty, Cat. 3 Slip Clutch Std	
Gauge Wheels	18" x 5.50" x 8" Turf Tires-4 ply	
Silt-Seeder Weight - lb	2" Knife Spacing = 38 3" Knife Spacing = 36	2" Knife Spacing = 56 3" Knife Spacing = 54

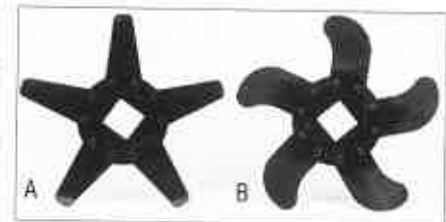
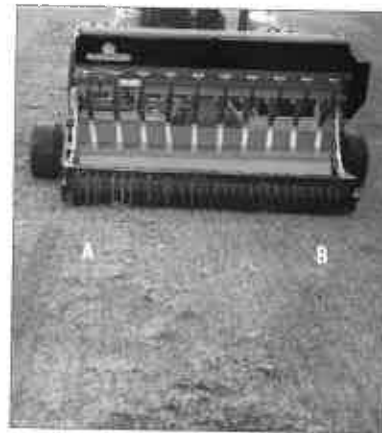

### Choice of Knives

(A) Straight, aggressive 3/16" thick knives prepare the soil by pulling up thatch, while (B) 10 gauge curved knives provide a minimum of surface disturbance.

Color Options: 



See dealer for complete warranty information.

## Precise metering and seed-to-soil contact.

The PS1572 Primary Seeder is perfect for the hometown landscaper to do lawns, community parks and areas between the curb and sidewalk. They also perform better than larger models in areas where light moguls, undulations, and depressions exist.



	PS1572
Horsepower	25-50 HP
Hitch	Cat 1
Working Width (cm)	70-1/2" (179)
Overall Width	79-1/8"
Overall Length	29-3/4"
Overall Height	39"
Weight - lb (3-Pt) (kg)	1165 (528)
Seedbox Construction	16 Gauge Front & Rear, 10 Gauge Endplates
Seedbox Capacity	6 Bushel
Output Range	Varies By Seed Variety, Consult Manual
Front Roller	29 Rings - 12" Diameter 1-1/2" Spindles w/ Sealed Ball Bearings
Rear Roller	30 Rings - 9-1/2" Diameter
Roller Spindles	1-1/2" Front 1" Rear w/Greaseable Bearings
Chain	#40 with Spring Loaded Idler
Seed Cups	10 Each
Track Removers	2 Each

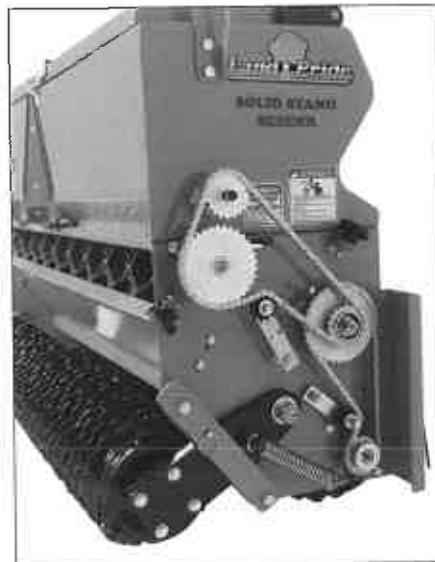

(Cover removed for photo.)

Various seeding rates can be obtained by turning the dual sprocket over. The easy drive system assures a consistent flow of seed. The rear roller is spring loaded to keep in constant contact with the ground, promoting healthy "seed-to-soil" contact.

"Precision seeding" is accomplished using proven fluted metering cups (shown here). Each flute grabs just the right amount of seed for even distribution. Millions of cups are in use for a variety of crops around the world.



Color Options:





## Affordability for food plots.

The Plot Ranger is an ideal tool for planting food plots by the avid hunter or the ultimate animal lover and is sized right to work behind a sub-compact to compact tractor, your ATV, UTV, or even your hunting truck.



Spreader is available for quick mounting to your Utility Vehicle or your Disc Harrow.



	FPS48
	Pull-Type
Disc Cutting Width (ewn)	40" - 50" (102 - 127)
Overall Width	54"
Height	52"
Length	104"
Weight - lb (kg) w/Spin Spreader & Packer	510 (231)
Weight Load on Each Disc	48 lbs
Number of Disc Blades	8
Disc Blade Size & Type	16" Notched
Blade Spacing	7-1/2"
Transport / Bouncing Tires	13" Diameter 4 Ply Tubeless
Bearing Hanger	3/8" Plate
Bearing Type, 2 per Gang	Self Aligning, Sealed Bearing
Gang Tube	3" x 2"
Gang Axis	1" Square High Carbon Steel
Disc Angle	Front Gang: 0°, 7°, 14° & 21° Rear Gang: 0°, 7°, 14° & 21°
Frame Construction	2" x 2" Square Tubular Design
Lifting Device	Electric Actuator, 12 Volt or Ratchet Jack
Rear Axle Pivot	Greaseable
Packer Roller Width	40-7/16"
Packer Roller Bearing	Greaseable
Spreading Device	Spin Spreader, 12V Electrically Operated
Spreader Hopper Lifting Ht.	42" Off Ground
Spreader Hopper Vol./Cap.	2 cu. ft. (15 gal.) (100 lbs. Maximum Capacity Weight)
Spin Spreader Deflector	Diverts Seed to Smaller Spreading Width
Small Seed Restrictor	Restricts Small Seed for Smaller Distribution Levels

### Color Options:



- Roller/packer raises above spreader for transport
- Seed deflector controls spreading width

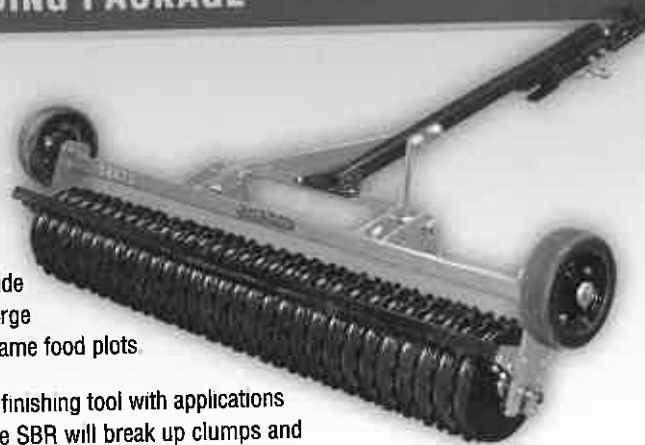

## SEED BED ROLLER

SBR72*	
Horsepower	18-52 HP
Hitch	Cat. 1 & Cat. 1 QH
Working Width (cm)	69" (175)
Weight - lb (kg)	442 (200) 3-Pt
Optional Pull Hitch	Easily Pivots for Ball or Clevis Hook-up
Roller Diameter	11-3/8"
Roller Material	Notched Gray Iron
Scraper	Profiled Roller Scraper
Tires	Transport Tires on Pull-Type
Stand	Hitch Support Stand
Options	Easily Converts from Pull-Type to 3-Point

SBR72 w/Optional Pull Hitch

Land Pride's 'seeding package' is a unique blend of products that work well by themselves, and compliment each other when used together with a Land Pride Disc Harrow. This package is ideal for large grassy areas, reclamation sites, or wild game food plots.

- **Seed Bed Roller** – this is an excellent finishing tool with applications from roadside use to landscaping. The SBR will break up clumps and dirt clods while pressing seed into the soil for seed to soil contact.
- **Electric Spin Spreader** – our Spin Spreader is easily calculated for a host of seed types, many of which we have put into a seed calculation chart for you. Electrically turn on and off from your tractor or vehicle seat.
- **Drag Harrow** – our Drag Harrow has light, medium and aggressive applications, simply by turning the harrow in different positions. Perfect for dragging a sports field or smoothing out recently cultivated ground.

Color Options:



SBR72 3-Point (Base Model)

## DRAG HARROWS

	DRG04	DRG06	DRG08
Hitch	2 Log Chains with Pull Ring		
Working Width (cm)	4' (122)	6' (183)	8' (244)
Weight - lb (kg)	89 (40)	138 (63)	185 (84)
Tine Diameter	1/2"		
Construction	High Carbon Steel Tine Construction		

- Can be flipped over for a more aggressive action

Color:

## ELECTRIC SPIN SPREADER

Volume/Capacity	2 cu ft Spin Spreader
Construction	Poly Hopper w/ Water Tight Poly Press Fit Lid
Spread Pattern	20 to 25 ft Wide w/u Deflector
Remote Control	Remote Tether Control

Color:

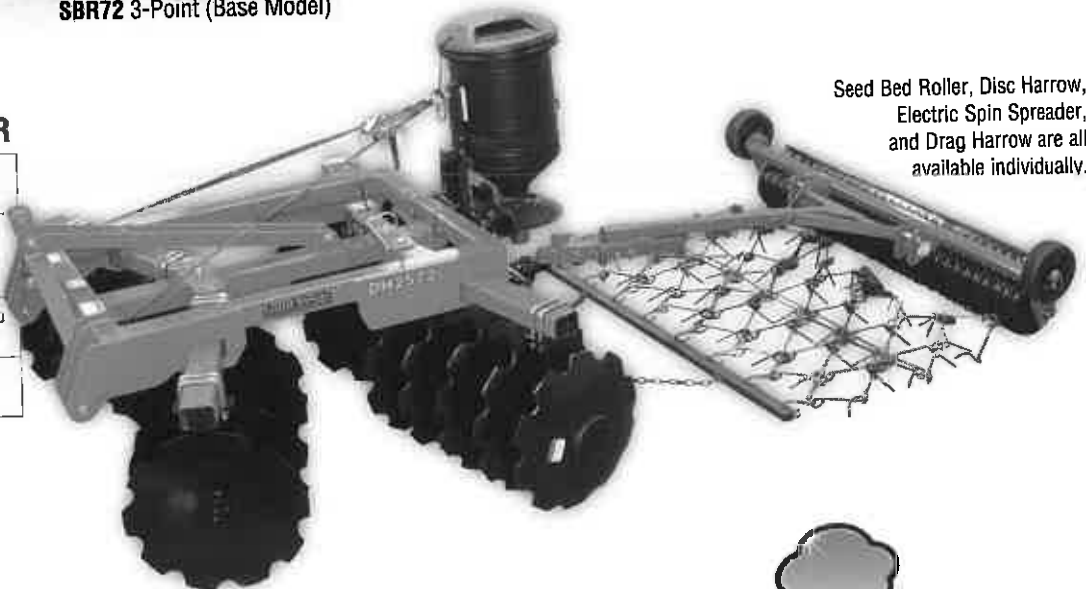

Seed Bed Roller, Disc Harrow, Electric Spin Spreader, and Drag Harrow are all available individually.





## Spreading made fast and easy with weatherproof hopper.

- Spin-type broadcast for even spreading
- One piece seamless Polyethylene hopper
- Adjustable delivery patterns
- Vinyl cover option to keep the elements out
- PTO Driven

### COMPARE TO OTHERS!

**Stainless Steel Parts**

**Spinner Plate**

**Spinner Vanes**

**Hopper Doors, Hardware  
and Adjustment Handle**

Featuring an all-steel frame, frontal splash plate and three available hopper sizes, Land Pride Broadcast Spreaders fit most landscape, nursery, hobby farm, sod farm and municipality uses.

	FSP500	FSP700	FSP1000
Min. Horsepower	15 HP	18 HP	20 HP
Hitch	Cat 1		
Capacity (kg)	350 lbs (158.7) 5.85 cu ft	563 lbs (255.9) 9.38 cu ft	673 lbs (305) 11.22 cu ft
Overall Dimensions	37.2" x 40.4"	44" x 46"	46.8" x 46.8"
Loading Height	3'	3' 4"	3' 9"
Weight - empty - lb (kg)	119 (54)	128 (58)	139 (63)
Net Spreadable Granular Width	23" - 54"		
Transmission Ratio	1:1		
Range of Spreading Possibility - lb/acres	44 - 890		



A built in tow hook handles up to 1200 pounds; just right for hauling extra sacks of fertilizer or seed.



Our agitator is standard equipment and is useful when spreading powder type materials that tend to bridge.

## Pull-Type salt, seed, sand, or top dressing spreader.

- Easily disengage spinner for transport
- Adjustment link for various hitch heights
- Two hopper sizes
- Hopper cover available to protect material
- 2" Ball hitch
- Ground driven



	PTS500	PTS709
<b>Hitch</b>	Pull-Type, 2" Ball Hitch Ground Driven	
<b>Delivery</b>	Spin-Type Broadcast	
<b>Hopper</b>	One Piece, Seamless Polyethylene	
<b>Dry Weight (kg)</b>	165 (75)	176 (80)
<b>Frame</b>	Heavy-Duty Tubular	
<b>Vanes and Spinner</b>	Stainless Steel	
<b>Adjustment Levers</b>	Plated	
<b>Loading Height</b>	54" Average	
<b>Max. Spreading Width</b>	39-46 ft	
<b>Hopper Capacity - lb (kg)</b>	350 (158)	563 (255)
<b>Pattern Settings</b>	Three	
<b>Overall Width</b>	41"	
<b>Wheel Size</b>	16 x 6 5-8	
<b>Acres Covered</b>	7-15 Acres per Hour (depending on slide opening)	

## Pendulum Spreaders offer a more consistent spread.

	PFS4000	PFS5050	PFS8010
<b>Hitch</b>	Cat 1	Cat 1 & 2	Cat 2
<b>Capacity</b>	925 lbs	1150 - *1390 lbs	2040 - **3000 lbs
<b>Delivery</b>	Pendulum-Type		
<b>Hopper</b>	One Piece, Seamless Fiberglass		Cone shape, polyethylene
<b>Frame</b>	Heavy-Duty Tubular		
<b>Driveline</b>	Shielded		
<b>Spreading Width</b>	20 - 46 Ft		
<b>Gearbox</b>	1-3/8" Shaft		
<b>Adjustment Levers</b>	Plated		
<b>Discharge Opening</b>	Manual, Optional Hydraulic	N/A	
<b>Additional Agitation</b>	Optional	N/A	

\*Optional top extensions needed for this capacity

### Various Spouts Available

- Broadcast (Standard)
- Banding (Wide)
- Banding (Narrow)
- Narrow Broadcast
- PTO Driven



Pendulum Spreaders offer a more consistent spread and delivery than broadcast spreaders.



**Ideal for light duty maintenance and landscaping.**



**15 & 16 Only**

Land Pride's economical RB05, RB15, and RB16 Series Rear Blades are an excellent and economical choice for leveling, grading, finishing, and backfilling. They are the perfect companion for your sub-compact or compact tractor.

The multitude of forward and reverse working angles, moldboard offset capability, as well as tilt on the RB16, allows the operator to work right up next to retaining walls, abutments and raised curbing. They are excellent for snow removal in the pulling or push blade mode. A retractable parking stand is included to accommodate easier blade removal, storage and remount capabilities.

	RB0548	RB0560	RB1560	RB1572	RB1584	RB1660	RB1672	RB1684
<b>Horsepower</b>	17-25 HP		17-40 HP			20-40 HP		
<b>Hitch</b>	Cat. 0 with Cat. 1 Pins, Cat. 1 Limited		Cat. 1			Cat. 1		
<b>Working Width (cm)</b>	48" (122)	60" (152)	60" (152)	72" (183)	84" (213)	60" (152)	72" (183)	84" (213)
<b>Approx. Weight - lb (kg)</b>	128 (58)	143 (65)	248 (112)	269 (122)	289 (131)	283 (128)	297 (134)	319 (145)
<b>Angling</b>	5 Fwd / 5 Rev Up to 30° Right or Left		7 Fwd Up to 45° 5 Rev Up to 30°			7 Fwd Up to 45° 3 Rev Up to 30°		
<b>Tilt</b>	N/A		N/A			5 Positions; Up to 15° Left or Right		
<b>Offset</b>	10" Left or Right		12" Left or Right			12" Left or Right		
<b>Moldboard Height</b>	13-1/2"		14"			14"		
<b>Moldboard Thickness</b>	1/4"		1/4"			1/4"		
<b>Cutting Edge</b>	3/8" x 3", Replaceable, Heat Treated		1/2" x 6", Reversible & Replaceable, Heat Treated			1/2" x 6", Reversible & Replaceable, Heat Treated		
<b>Options</b>	N/A		Skid Shoes			Skid Shoes, Hydraulic Angling		

Color Options:



## Everyday blades; Dirt, Snow, Farm, Landscape – About as versatile as it gets!

The Land Pride RB26 and RB37 Series Rear Blades offer 3-way positioning (blade angle, blade tilt, and blade offset) and are an excellent choice for leveling, grading, or backfilling. They excel in snow removal in either the pulling or push blade mode. Their offset and tilt capability make them an excellent choice for construction and maintenance of drainage ditches, waterways, soil contours, and for maintaining silage pit operations. Optional hydraulic angling kits are available for both models.

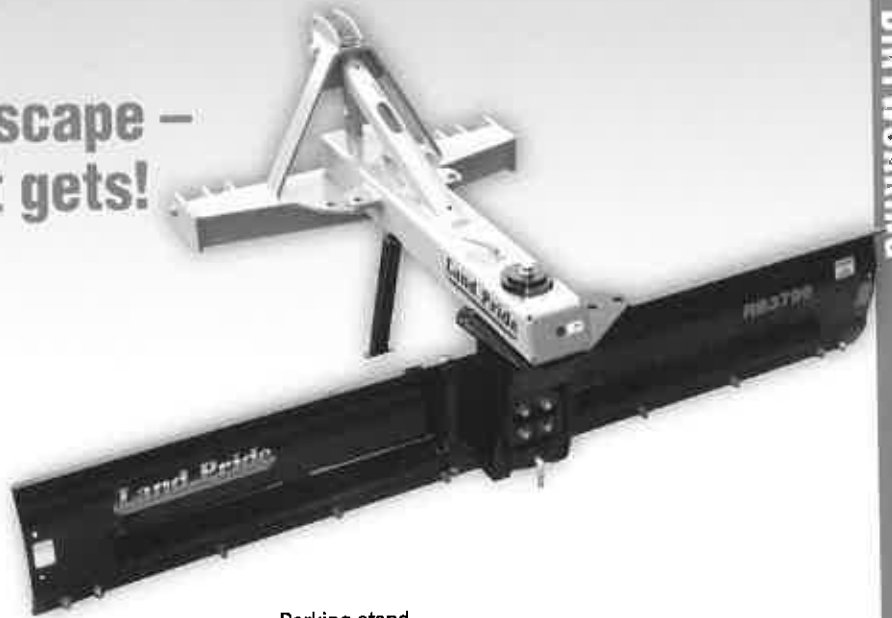

- Parking stand
- Optional side plates and skid shoes
- Optional hydraulic angle kit
- Cat. 1 or 2



- Parking stand
- Second top link hole for additional lifting leverage
- Optional side plates and skid shoes
- Optional hydraulic angle kit

	RB2672	RB2684	RB2696	RB3772	RB3784	RB3796
<b>Horsepower</b>	25-60 HP			35-80 HP		
<b>Hitch</b>	Cat. 1			Cat. 1 & 2 Combination		
<b>Working Width (cm)</b>	72" (183)	84" (213)	96" (244)	72" (183)	84" (213)	96" (244)
<b>Weight - lb (kg)</b>	369 (167)	396 (180)	425 (193)	595 (270)	630 (286)	665 (302)
<b>Angling</b>	7 Fwd Up to 45°, 3 Rev Up to 60°			7 Fwd Up to 45°, 3 Rev Up to 30°		
<b>Tilt</b>	5 Positions, Up to 15° Left or Right, 30° Total			7 Positions, Up to 22.5° Left or Right, 45° Total		
<b>Offset</b>	12"			26" Left or Right		
<b>Moldboard Height</b>	17-1/2"			17"		
<b>Moldboard Thickness</b>	5/16"			5/16"		
<b>Kingpin</b>	3-1/2" Tube			2-1/2" Solid Shaft		
<b>Cutting Edge</b>	1/2" x 6", Reversible & Replaceable, Heat Treated			1/2" x 6", Reversible & Replaceable, Heat Treated		
<b>Options</b>	Side Plates, Skid Shoes, Hydraulic Angling			Side Plates, Skid Shoes Hydraulic Angling		

Color Options:



## The perfect all-around blade.

Our RBT35 Series Blade is just right for use in landscape, construction, farming or snow removal. Looked upon as the perfect all-around blade, the RBT35 Series is offered with optional hydraulic function for Tilt, Offset and Angle.

- All hydraulic
- The optional cushion valve can help protect the cylinders in the event an obstruction is hit
- The optional rear gauge wheel can turn your blade into an excellent grading tool



Make changes  
**On The Go**  
with our 3-Way  
Hydraulic  
Rear Blades



	RBT3584	RBT3596
<b>Horsepower</b>	2WD: 35-80 HP 4WD: Up to 85 HP	
<b>Hitch</b>	Cat. 1 & 2	
<b>Working Width (cm)</b>	84" (213)	96" (244)
<b>Weight - lb (kg)</b>	709 (322)	745 (338)
<b>Maximum G.V.W. - lb (kg)</b>	9500 (4318)	
<b>Blade Angle</b>	9 Positions (Manual) Up to 50° Fwd & Rev (Hydraulic)	
<b>Tilt</b>	Up to 20°	
<b>Tilt Cylinder</b>	2" x 6" x 1-1/4"	
<b>Swing Offset</b>	Up to 30" Left and Right	
<b>Offset Cylinder</b>	3-1/2" x 14" x 1-1/4"	
<b>Moldboard Height</b>	17"	
<b>Moldboard Thickness</b>	5/16" with 3/16" Tapered Reinforcement Channel	
<b>Cutting Edge</b>	1/2" x 6", Reversible & Replaceable, Heat Treated	
<b>Options</b>	Skid Shoes, End Plates Gauge Wheel, Double Selector Valve, Cushion Valve	

Color Options: 



## Our larger blades are excellent farm blades, from barns to pastures to fields . . . our blades can do it all!

Land Pride's RBT40 Series 3-Way Hydraulic Rear Blades are built tough from the ground up for applications ranging from landscaping, construction, snow removal, and feedlot cleaning. Designed to handle tractors up to 100 HP, this blade is also ideal for ditching, road grading and all-around farm use. By using optional hydraulics at all three positions, changes to angle, tilt, and offset can be made while on the go. Optional skid shoes and side plates are available for more precise results.

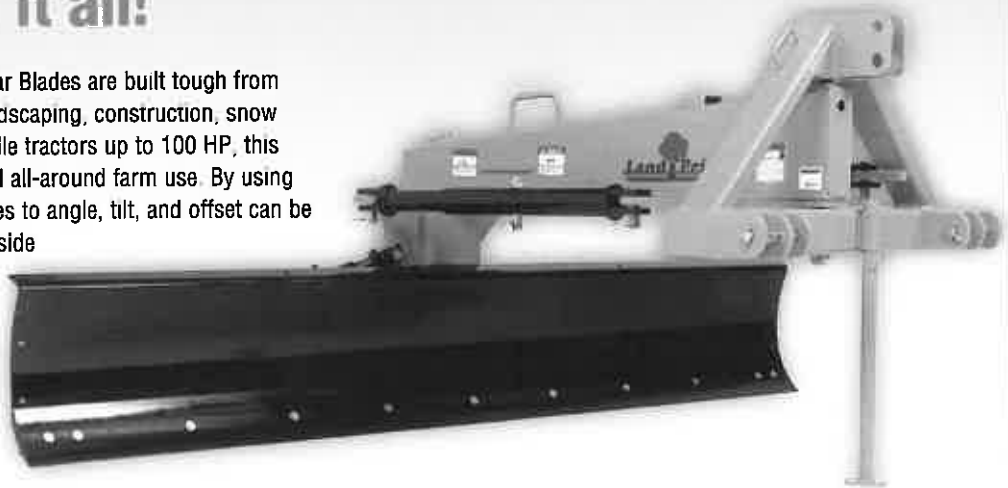

Skid shoes and end plates are ideal tools for large grading jobs or snow removal.

Make changes  
**On The Go**  
with our 3-Way  
Hydraulic  
Rear Blades



	RBT40	RBT40S
<b>Horsepower</b>	2WD 65-100 HP 4WD Up to 75 HP	
<b>Hitch</b>	Cat. 1 & 2	
<b>Working Width (cm)</b>	96" (244)	108" (274)
<b>Weight - lb (kg)</b>	848 (385)	898 (407)
<b>Maximum G.V.W. - lb (kg)</b>	9500 (4318)	
<b>Blade Angle</b>	15 Positions (Manual) Forward and Reverse, Up to 45°	
<b>Angle Cylinder</b>	3-1/2" x 16" x 1-1/4"	
<b>Tilt</b>	Up to 15°	
<b>Tilt Cylinder</b>	3" x 6" x 1-1/4"	
<b>Swing Offset</b>	Up to 30° Left and Right	
<b>Offset Cylinder</b>	3-1/2" x 16" x 1-1/4"	
<b>Moldboard Height</b>	17"	
<b>Moldboard Thickness</b>	5/16" with 1/4" Tapered Reinforcement Channel	
<b>Cutting Edge</b>	1/2" x 6", Reversible & Replaceable, Heat Treated	
<b>Options</b>	Skid Shoes, Side Plates, Hydraulic Cushion Valve Double Selector Valve	

Color Options: 





**Built tough...where it really counts.**

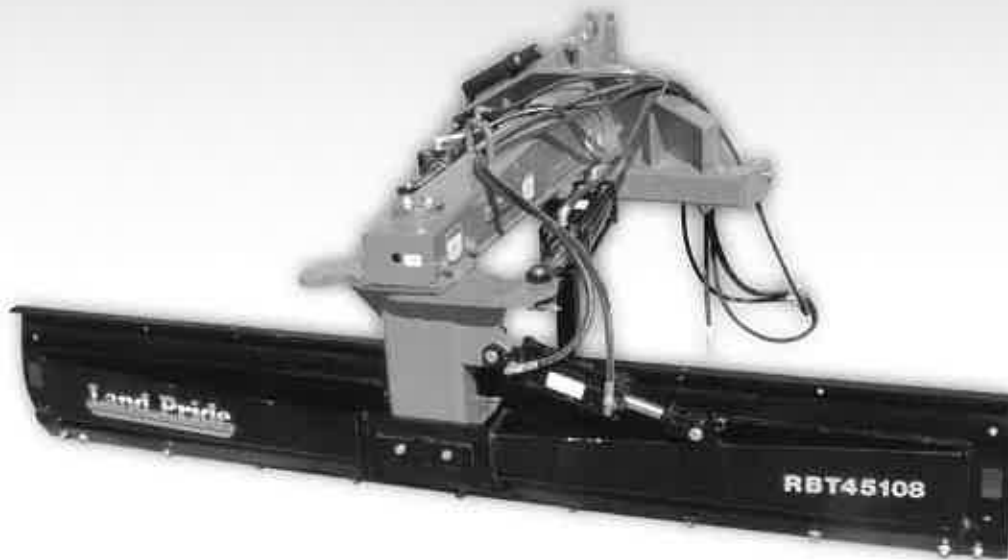

Optional cushion valve protects cylinders and blade components during extreme impacts. For use on RBT40 & 45 Models.



Optional single or dual gauge wheels add accuracy and simplify grading operations.

**Make changes  
On The Go**  
with our 3-Way Hydraulic Rear Blades

	RBT4506	RBT45108	RBT55120
<b>Horsepower</b>	70-125 HP		90-180 HP
<b>Hitch</b>	Cat 2 & 3		Cat 2 & 3
<b>Working Width (cm)</b>	96" (244)	108" (274)	120" (304)
<b>Weight - lb (kg)</b>	1120 (513)	1166 (528)	1,753 (795)
<b>Maximum G.V.W. - lb (kg)</b>	9,500 (4309)		15,000 (6818)
<b>Blade Angle</b>	Fwd & Rev Up to 45°		Fwd & Rev Up to 45°
<b>Angle Cylinder</b>	4" x 16"		4-1/2" x 16" x 2"
<b>Tilt</b>	Up to 15°		Up to 30°
<b>Tilt Cylinder</b>	3" x 6" x 1-1/4"		3" x 8" x 1-1/4"
<b>Swing Offset</b>	Up to 35° Left and Right		33°
<b>Offset Cylinder</b>	4" x 16"		4-1/2" x 16" x 2"
<b>Moldboard Height</b>	18"		19"
<b>Moldboard Thickness</b>	5/16" with 1/4" Boxed Reinforcement		5/16" with 1/4" Boxed Reinforcement
<b>Cutting Edge</b>	1/2" x 8", Reversible & Replaceable, Heat Treated		1/2" x 8", Reversible & Replaceable, Heat Treated
<b>Options</b>	Skid Shoes, End Plates, Single or Dual Gauge Wheel, Cushion Valve, Double Selector Valve		Skid Shoes, End Plates, Hardened Wear Plates, Hydraulic Single Gauge Wheel, Hydraulic Dual Gauge Wheel, Double Selector Valve



Shown with optional end plates.

RBT45 & 55 pivot weldment features a 1" thick plate steel turntable, 3/4" thick tilt pivot bushing and a 4" solid kingpin.



Color Options:





**1/2" Thick moldboard...  
this blade can tackle most  
jobs thrown its way!**



	RBT6010	RBT6012
<b>Horsepower</b>	2 WD 225 HP 4 WD 200 HP	2 WD 175 HP 4 WD 160 HP
<b>Hitch</b>	Cat 2 & 3	
<b>Working Width (cm)</b>	10' (304)	12' (366)
<b>Weight - lb (kg)</b>	2,442 (1108)	2,582 (1172)
<b>Blade Angles</b>	Up to 45°, Fwd & Rev 5" x 18" Cylinder	
<b>Offset</b>	Up to 55° Left & Right 5" x 18" Cylinder	
<b>Tilt</b>	Up to 15°, 3-1/2" x 8" Cylinder	
<b>Moldboard Height</b>	19"	
<b>Moldboard Thickness</b>	1/2" Thick w/Reinforcement Channel	
<b>Kingpin</b>	4-1/2" Solid Steel Bar	
<b>Cutting Edge</b>	1/2" x 6", Reversible & Replaceable, Heat Treated	

\* Quick Hitch cannot be used with optional gauge wheels.

**Color Options:**



- Hydraulic adjustments with cylinders & hoses
- Hydraulic tip storage
- Main frame: fully welded formed box
- Retractable parking stand
- Options: gauge wheels, end panels, skid shoes

Rear blades don't come any tougher than Land Pride's RBT45, RBT55, and RBT60 Series 3-Way Rear Blades. They are built tough to handle leveling, finish grading, and backfilling applications involving roadwork, construction, landscaping, nurseries, drainage ditches, feedlot cleaning, farm use, and snow removal.

The 19" tall rolled moldboards can be hydraulically angled left or right up to 45°, the ends can be tilted up or down by as much as 15°, and the whole blade can be offset to the left or right. The blade can also be rotated 180° for blading in reverse with the same angling, tilting, and offset capabilities. Available accessories include gauge wheels for good depth control, end plates for holding material, and skid shoes for blade protection.

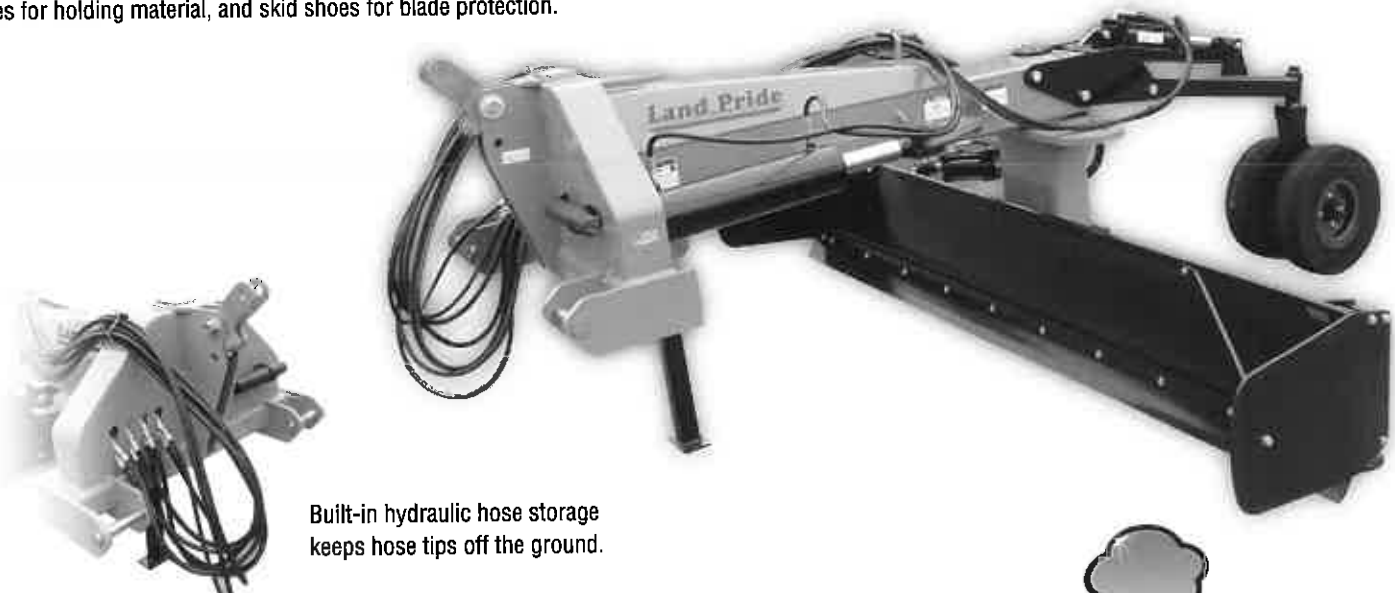

Built-in hydraulic hose storage keeps hose tips off the ground.



## Productivity in a small package.

The Land Pride BB05 Series Fixed Bar Box Scrapers are designed for Category 0, 1, and 1 limited 3-point hitch for mounting to subcompact tractors. The Land Pride BB12 Series Box Scrapers are designed for Category 1, 3-point hitch or Quick-Hitch System mounting to tractors up to 30 HP range. Both Box Scraper models are ideal for ripping, leveling, finish grading, and backfilling applications at small feedlots, outdoor arenas, building sites, and maintenance operations for small landowners. The manually adjustable ripping shanks and the fore and aft cutting blades make these units especially effective and productive for small projects.



### BB05 SERIES

- Forward and Reverse cutting edges
- Rolled moldboard
- Clevis hitch aids in hooking to tractor
- Heat treated shanks with replaceable tips

### BB12 SERIES

- Forward and Reverse cutting edges
- Formed moldboard
- Lower clevis hitch aids in hooking to tractor
- Heat treated shanks with replaceable tips

	BB0548	BB0554	BB1248	BB1254	BB1260	BB1266	BB1272
Horsepower	17-25 HP		17-30 HP				
Hitch	Cat. 0, 1 and 1 Limited		Cat. 1				
Working Width (cm)	48" (122)	54" (137)	48" (122)	54" (137)	60" (152)	66" (168)	72" (183)
Height of Moldboard	13-5/16"		15-3/8"				
Side Panel Material	3/16"		3/16" Thick by 16" High				
Depth of Bucket	18-1/2"		25-1/8"				
Weight - lb (kg)	277 (126)	298 (135)	318 (143)	325 (147)	348 (157)	370 (168)	404 (183)
Number of Shanks	4	4	4	4	4	6	6
A-Frame Material	3/8" x 2-1/2" Flat Bar		1/2" x 3"				
Cutting Edges	Two 3/8" x 3" High Carbon Heat Treated Blades, Reversible & Replaceable		Two 3/8" x 6" High Carbon Heat Treated Blades, Reversible & Replaceable				

Color Options:  



Level, finish, grade,  
and backfill -  
all with one tool.



DIRTWORKING

Land Pride's BB15 and BB25 Series Fixed Bar Box Scrapers are ideal for ripping, leveling, finish grading, and backfilling applications at feedlots, outdoor arenas, and construction sites, or for maintenance operations on lanes or roadways. Each model offers five different working widths to choose from. The roll-formed moldboard keeps materials flowing putting less drag on the Box Scraper, resulting in lower HP requirements and faster working conditions. The rear-mounted blade allows for backfilling trenches or along foundations.

	BB1560	BB1566	BB1572	BB2560	BB2566	BB2572	BB2584	BB2596
<b>Horsepower</b>	17-40 HP			25-55 HP				
<b>Hitch</b>	Cat 1			Cat 1				
<b>Working Width (cm)</b>	60" (152)	66" (168)	72" (183)	60" (152)	66" (167)	72" (182)	84" (213)	96" (244)
<b>Height of Moldboard</b>	17"			17"				
<b>Side Panel Material</b>	5/16"			3/8"				
<b>Depth of Bucket</b>	22"			22"				
<b>Overall Depth</b>	31-1/2"			31-1/2"				
<b>Overall Height</b>	35"			35"				
<b>Weight - lb (kg)</b>	428 (194)	450 (204)	504 (229)	471 (214)	500 (227)	549 (249)	593 (269)	658 (298)
<b>Number of Shanks</b>	4	5	6	5	5	7	7	8
<b>A-Frame Material</b>	1/2" x 3" Flat Bar			1/2" Plate				
<b>Cutting Edges</b>	Two 1/2" x 6" High Carbon Heat Treated Blades, Reversible & Replaceable			Two 1/2" x 6" High Carbon Heat Treated Blades, Reversible & Replaceable				



Side panel gussets reinforce the structural integrity during extreme conditions.



Color Options:



## Choose from manual or hydraulic retractable box scrapers.



**MR1572**

Color Options: 

The easy and convenient retractability of the scarifier shanks on the MR1572 and HR2572 makes them highly productive and ideal for ripping, leveling, finish grading, and backfilling applications at commercial feedlots, outdoor arenas, building sites, and maintenance operations on farm and ranch lanes or roadways or construction sites.

The roll-formed moldboard keeps materials flowing which puts less drag on the Box Scraper, resulting in lower HP requirements and faster working conditions. Shanks on the MR15 are kept in the up or down position with a positive locking system, keeping the scarifier bar from bouncing in transport and tight during field use.

	MR1572	HR2572
Horsepower	2WD: 20-50 HP 4WD: 25-40 HP	30-60 HP
Hitch	Cat 1	
Working Width (cm)	72" (183)	
Height of Moldboard	18-1/2"	20-1/2"
Depth of Side Panels	27-1/2"	34"
Side Plate Material	3/8"	
Weight - lb (kg)	615 (279)	851 (386)
Number of Shanks	7	
Cutting Edges	Two 1/2" x 6" High Carbon Heat Treated Blades, Reversible & Replaceable	

- Self locking down position
- Hydraulic raising and lowering of shanks on HR25
- 3 Position shank with replaceable tip
- Rigid backfill blade



**HR2572**

Color Options: 

The hydraulic retractable ripping shanks on the HR25, in combination with the 21" double-thick moldboard design, make these units highly productive for construction projects.

## Hydraulic retractable box scrapers, available in highback or lowback.

The HR/HRL35 Series Retractable Box Scrapers meet dirt moving and soil contouring needs of landscapers, contractors, nurseries, sod growers, farmers, ranchers and municipalities. Soil contouring productivity is dramatically increased with utilization of the hydraulically controlled retractable scarifier.

The front blade mounted on the moldboard is ideal for soil redistribution and soil leveling. A second blade mounted on the hinged rear gate further enhances the ability of the Box Scraper to redistribute and level soil. Both the front and rear blades are replaceable and can be flipped over to extend blade life. The HR/HRL35 is used for finishing and fine grading when the hinged rear gate is bolted in place. Unbolt the rear gate and the unit's front blade will penetrate deeper into the soil. Place the tractor in reverse and the rear blade can be used to backfill.

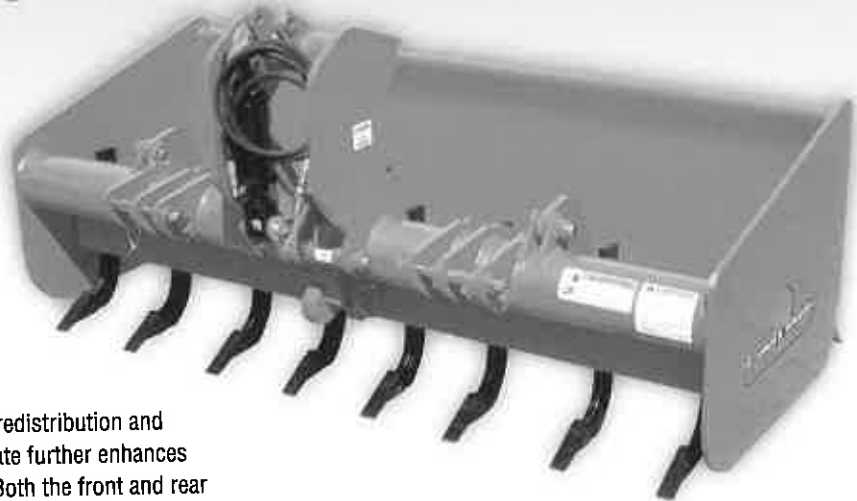

	HRH3578 Lowback	HRH3584 Highback
Horsepower	40-65 HP	
Hitch	Cat 1 & 2	
Working Width (cm)	78" (198)	84" (213)
Height of Moldboard	17"	23"
Depth of Side Panels	30"	
Side Plate Material	1/2"	
Overall Depth	43-1/2"	
Capacity Cu. Ft.	26	31
Weight - lb (kg)	981 (445)	1119 (508)
Number of Shanks	8	
Cutting Edges	Two 1/2" x 6" High Carbon Heat Treated Blades, Reversible & Replaceable	

Color Options: 

- Raise and lower shanks hydraulically
- Hardened bushings in upper and lower hitch
- Floating or fixed rear gate
- Heat treated spring steel shanks



Perfect for garden tractors, zero turn mowers and utility vehicles.

- Optional tailwheels are easily flipped for road or field use.
- Material tray allows for additional weight for better penetration.

Additional weight not included.

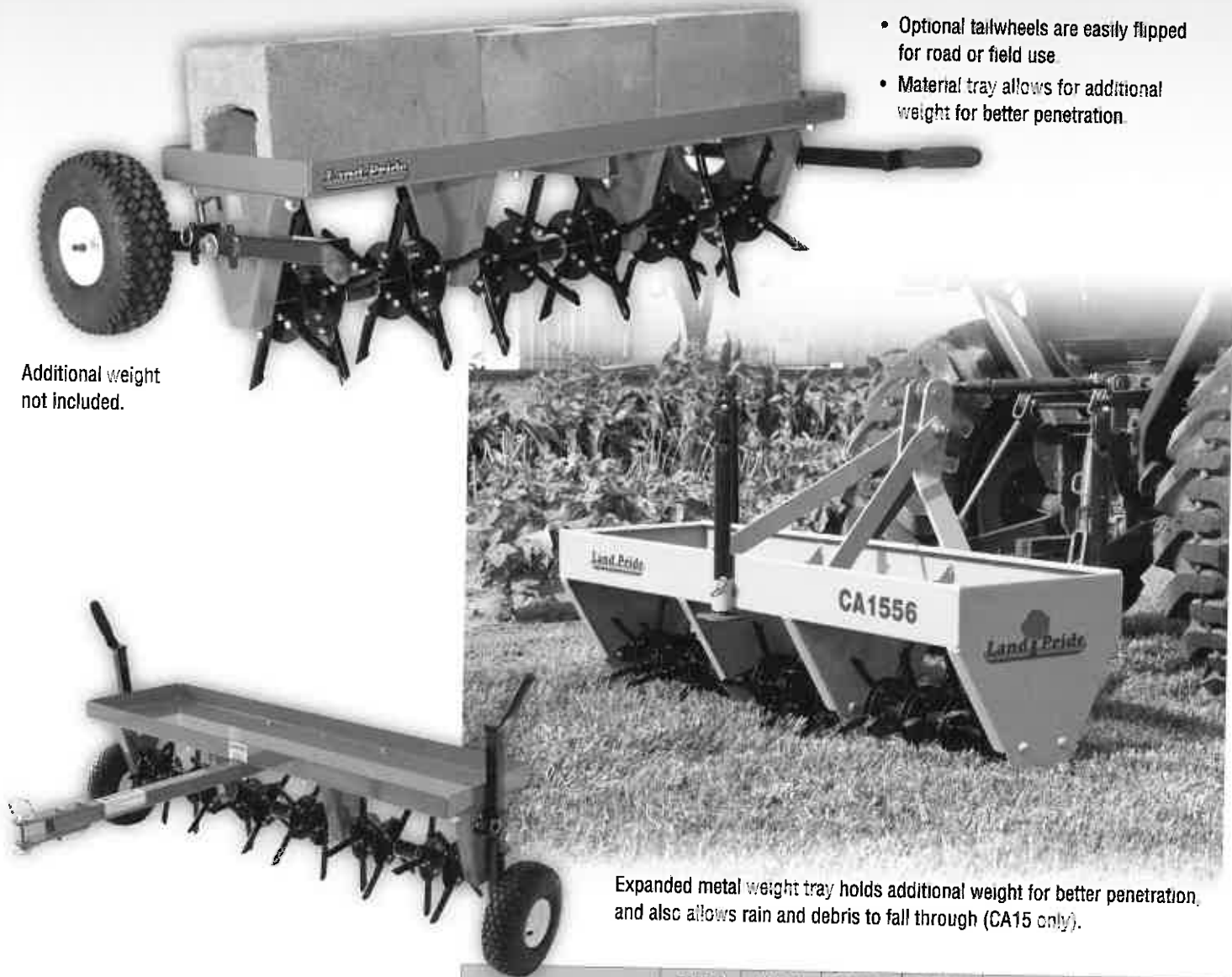

Expanded metal weight tray holds additional weight for better penetration, and also allows rain and debris to fall through (CA15 only).

Color Options:



	CA0540	CA0548	CA0556	CA1548	CA1556	CA1564	CA1572
<b>Hitch</b>	Pull-Type			Cat. 0, 1, 1 Ltd			
<b>Working Width (cm)</b>	36" (91)	44" (112)	52" (132)	41" (104)	50" (127)	58" (147)	66" (168)
<b>Overall Width (cm) (w/Wheels)</b>	50" (127)	58" (147)	66" (168)	48" (123)	56" (142)	64" (163)	72" (183)
<b>Overall Length</b>	38-7/8" (48" w/wheels)			24-7/8"			
<b>Spoon Material</b>	1/2" Hardened Steel			1/2" Hardened Steel			
<b>Spoon Spacing (Fwd Travel)</b>	8-1/2"			6"			
<b>Spoon Penetration</b>	3"			3" - 4-1/2"			
<b>Support Stand</b>	N/A			3 Each			
<b>Gang Assembly</b>	Greaseable			Greaseable			
<b>Transport Wheels</b>	2 Optional			N/A			
<b>Plug Size</b>	1/2"			1/2"			

# CA25 CORE AERATORS

**HITCH**  
Cat. 1

DIRTWORKING



Optional Water Tanks shown for additional weight to aid in spoon penetration.

- 60" Tanks add up to 490 lbs.
- 72" Tanks add up to 600 lbs.



The 3/4" spoon is beveled to easily penetrate the ground and create a nice clean hole.

	CA2530	CA2572
Hitch	Cat 1	
Working Width (cm)	60" (152)	72" (183)
Weight - lb (kg) (w/o added weight)	464 (210)	480 (218)
Number of Spoons	96	
Spoons	Replaceable 3/4" closed, case hardened	
Spoon Spacing-In	7" - Forward Travel	
Gang Spacing	5-1/2"	6-1/2"
Number of Gangs	12	
Water Tank Capacity (Gallons per tank)	29	36
Full Water Tank Wt - lb (kg)	490 (222)	600 (272)
Plug Size	3/4"	

Color Options:



## CR25 SERIES STRAW CRIMPER

### Keep soil and seed where you put it.

If heat, erosion, or run-off is a problem, crimping straw into the ground needs to be the final step in grass seeding.



	CR2572
Hitch	Cat 1
Working Width (cm)	69" (175.3)
Overall Width (cm)	80" (203)
Weight - lb (kg)	475 (215)
Height	41"
Number of Discs	12
Disc Spacing	6-1/2"
Flat, Notched Discs Disc Hubs	Heat-treated Greaseable
Cast Iron Hubs	4 Bolt
Storage Stands	4, One in Each Corner
Heavy Tubular Frame	2-1/2" x 2-1/2" x 3/16"
Optional	Water Tanks for Additional Weight
Water Tank Capacity	36 Gallons per Tank
Full Water Tank Weight	600 lbs

Color Options:





## Food plots and small farms... just right for the Land Pride Disc Harrow.



The Land Pride DH10 Series Disc Harrow opens and breaks up the soil surface to help prepare the soil seedbed for planting. The forward gang has aggressive notched discs while the rear gang has a choice of notched or smooth discs to quickly break up and evenly redistribute the finely cultivated topsoil. The DH10 Series Disc Harrows have applications in homeowner landscaping, small nurseries, gardens, small hobby farms, wild game food plots, and medium-duty residential use.

Disc gangs on the DH15 Series can be ordered with smooth or notched arrays for lighter or more aggressive applications based on customer needs. The DH15 is at home in applications from commercial landscaping, nurseries, and large gardens to small farms and municipal

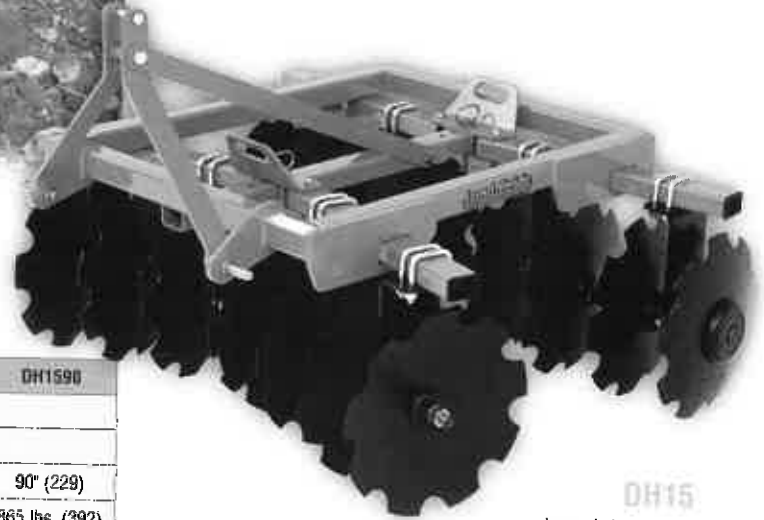

**DH15**

Just right to use  
between tree rows or  
to fill in center-pivot  
irrigation tracks.

	DH1048	DH1060	DH1560	DH1572	DH1590
<b>Horsepower</b>	Max. 40 HP		Max. 65 HP		
<b>Hitch</b>	Cat. 1		Cat. 1		
<b>Working Width (cm)</b>	48" (122)	60" (152)	80" (152)	72" (183)	90" (229)
<b>Weight (kg)</b>	420 (191)	548 (249)	628 lbs (285)	714 lbs (324)	865 lbs (392)
<b>Disc Blade Size</b>	16"	18" or 18"	18" Diameter		
<b>Disc Type</b>	Notched or Smooth		Notched or Smooth		
<b>No. of Disc Blades</b>	12	18	18	20	24
<b>Disc Blade Spacing</b>	7-1/2"		7-1/2"		
<b>Bearing Hanger</b>	3/8" Plate, 5/8" U-bolt		3/8" Plate, 5/8" U-bolts		
<b>Bearing Type</b>	2 per Gang - Self Aligning, Sealed Bearings		2 per Gang - Self Aligning, Sealed Bearings		
<b>Angling</b>	0, 7, 14, 21 Degrees (60° w/Angling Adj Handle)		0, 7, 14, 21 Degrees w/Angling Adjustment Handle		
<b>Frame Tubes</b>	2" Square		2-1/2" Square		
<b>Gang Tubes</b>	3" x 1-1/2"		3" x 2"		
<b>Gang Axle</b>	1" Square, High Carbon Steel		1" Square, High Carbon Steel		
<b>Weight per Disc (kg)</b>	35 (16)	34 (15)	38 lbs (17)	34 lbs (15)	36 lbs (16)
<b>Center Sweep Option</b>	N/A		9" Sweep		
<b>Disc Scrapers</b>	N/A		Optional, Adjustable		

**Color Options:**



## Not all Disc Harrows are created equal.

- Tubular frame instead of angle iron
- Self aligning, sealed ball bearings
- Thick plate steel bearing hangers
- Bearing hangers with 2 U-bolts
- Front and rear leveling
- Optional furrow fillers, disc scrapers, center sweep, SMV Kit, and Tongue Jack



Disc scrapers are available to reduce build-up on discs.



**DH25**  
Heavy-duty 1/2" thick bearing hangers resist the high torque from two 5/8" U-bolts.



**DH35**  
Heavy-duty 5/8" thick bearing hangers resist the high torque from two 3/4" U-bolts.

	DH2572	DH2596	DH3510	DH3512
<b>Horsepower</b>	40-100 HP		45-100 HP	
<b>Hitch</b>	Cat. 1 & 2		Pull-type Hitch with Clevis	
<b>Working Width (cm)</b>	72" (183)	96" (244)	10'6" (320)	12' (366)
<b>Weight - lb (kg)</b>	947 (430)	1143 (518)	2491 (1130)	2747 (1246)
<b>Disc Blade Size</b>	20" or 22" Diameter		20" or 22" Diameter	
<b>No. of Disc Blades</b>	20	24	28 or 32	32 or 36
<b>Disc Blade Spacing</b>	7-1/2"		7-1/2" or 9"	
<b>Bearing Hanger</b>	1/2" Plate, 2 Each 5/8" U-bolts		5/8" Plate, 2 Each 3/4" U-bolts	
<b>Bearing Type</b>	Self Aligning, Sealed Bearings 2 per Gang		Self Aligning Bearings 3 to 4 Bearings per Gang	
<b>Front Gang Angling</b>	0, 7, 14, 21 Degrees		Front 15, 18, 21 Degrees	
<b>Rear Gang Angling</b>	7, 14, 21 Degrees		12, 15, 18 Degrees	
<b>Frame Tubes</b>	3" Square		3" x 5"	
<b>Gang Tubes</b>	4" x 3"		3" x 5" x 1/4" Wall Tubing	
<b>Gang Axle</b>	1-1/8" Square, High Carbon Steel		1-1/8" Square, High Carbon Steel	
<b>Weight per Disc - lb (kg)</b>	47	48	79-84	76-82
<b>7-1/2" Spacing</b>	(21)	(22)	(36-38)	(34-37)
<b>Weight per Disc (kg)</b>	51	52	87-93	81-86
<b>9" Spacing</b>	(23)	(24)	(39-42)	(37-39)
<b>Transport Tires</b>	N/A		2 Std. 9.5Lx15, 4 Optional	
<b>Center Sweep Option</b>	9" Sweep		9" Sweep	
<b>Disc Scrapers</b>	Optional, Adjustable		Optional, Adjustable	



Color Options: 



## Quickly create channels for small irrigation ditches.

The DT35 Ditcher features a standard 1" ripper shank, adjustable impeller head, and reversible/replaceable cutting edges. The DT35 quickly creates channels for small irrigation ditches and for efficiently diverting water from unwanted areas.



	DT35
Horsepower	30-60 HP
Hitch	Cat. 1 & 2, Quick-Hitch Adaptable
Impeller	4 Adjustable Blades with Replaceable Cutting Edges
Impeller Settings	16" Narrow Trench, 18" Wider & Deeper Trench
Driveline	Cat. 4 with Shearbolt
Material Control Deflector	Manual
1" Ripper Shank	Standard
Drive Chain	#80 Roller Chain Fully Enclosed in Oil Bath
Chain Tightener	Easily Accessible
Storage Stands	Standard
Depth Controlling Skid Shoe	Replaceable, 3/8" Thick

Color Options: 



## A versatile tool to use in many water control applications.

Cleaning water ditches along roadsides or in farm fields to drain standing water away from crops, the DT55 Ditcher makes it simple. The 20" impeller leaves a clean and sculptured trough to keep water flowing freely from unwanted areas. With the Material Control Chute in place, dirt can be placed just next to the machine, or thrown many feet away to reshape terraces.

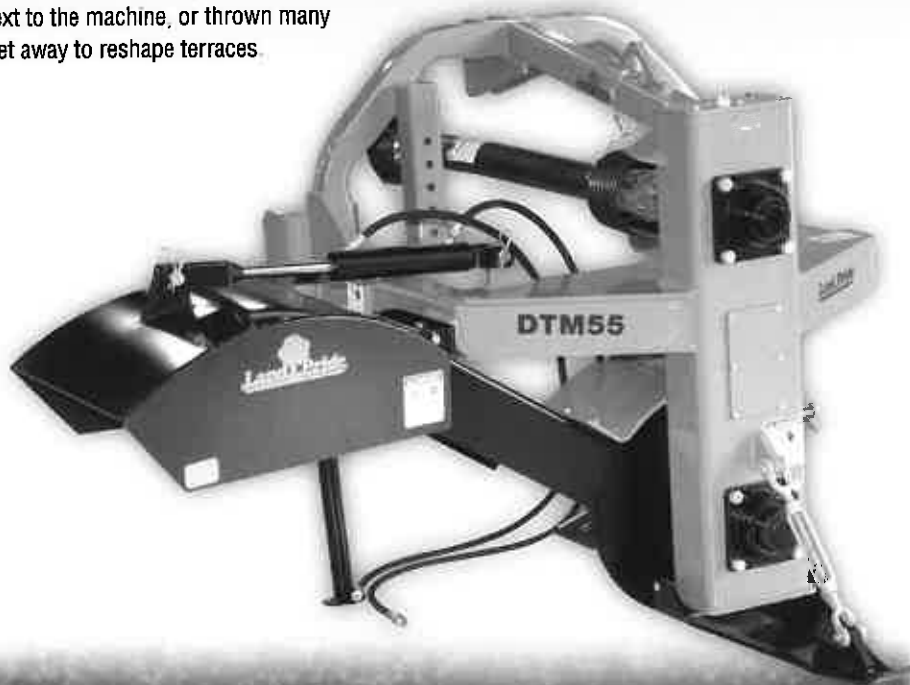

	DT55	DTM55
<b>Horsepower</b>	60-150 HP	
<b>Hitch</b>	Cat. 2 & 3	
<b>Tractor PTO</b>	540 rpm	1000 rpm
<b>Weight - lb (kg)</b>	900 (408) (w/o options)	
<b>Impeller</b>	20" Reinforced	
<b>Impeller Blades</b>	6 ea. 3/8" Thick Replaceable Hardened AR400 Material	
<b>Lubricated Chain Drive</b>	Double 80 Chain with Spring Loaded Idler	
<b>Input/Output Shafts</b>	2-1/4" ID Ball Type Bearings	
<b>Driveline</b>	Cat. 5 with Shear-Bolt	
<b>Material Control Chute (Optional)</b>	Manual or with 2" x 8" Hydraulic Cylinder & Hoses	
<b>Depth Control Wheel (Optional)</b>	16.5 x 6.50-8 Pneumatic Tire, Adjustable from Cutting Edge Height to 10" Below	
<b>Ripper Shank (Optional)</b>	3 Height Adjustments, Cutting Edge Depth to 5" Below	
<b>Skid Shoe (Optional)</b>	3/8" Thick, Replaceable	
<b>Parking Stands</b>	Dual Parking Stands for Storage Stability	

Color Options:



Some early models not QH adaptable

### OPTIONS

- Rear skid shoe helps control depth
- Material chute puts dirt where you want it
- Ripper shank tears through hard packed soils moving smaller material into the impeller path
- Gauge wheel for depth control



## Reshape country roads, waterways and terraces.

Land Pride BB45 Series Pull-Type Drag Scrapers are ideal for moving large quantities of material, leveling, and finish grading. Material can be transferred by dragging it to nearby locations and raising the scraper to deposit the load. Surfaces can be graded and leveled by scraping material from high areas and allowing accumulated material to flow under the grader blade in to lower areas.

	BB4596	BB4510	BB4512
Horsepower	70-130 HP		
Hitch	Pull-type		
Working Widths (cm)	96" (246)	10' (305)	12' (366)
Clevis	Swivel Ball, Clevis or Swivel Clevis		
Tongue	Removable		
Capacity	1-3/4 cu yd	2-1/4 cu yd	2-3/4 cu yd
Dump Clearance	21"		
End Plates	3/8"		
Moldboard	1/4"		
Cutting Edge	1/2" x 6"		
Axle	Fixed or Tilt		
Tilt Cylinder	3" x 8"		
Tilt Angle	3-1/2 Degrees, 7"	3-1/2 Degrees, Approx 8"	
Tires & Rim	15" Implement Recap, 5 Bolt, 4.5" Rim		
Light Kit	Dual, Optional		

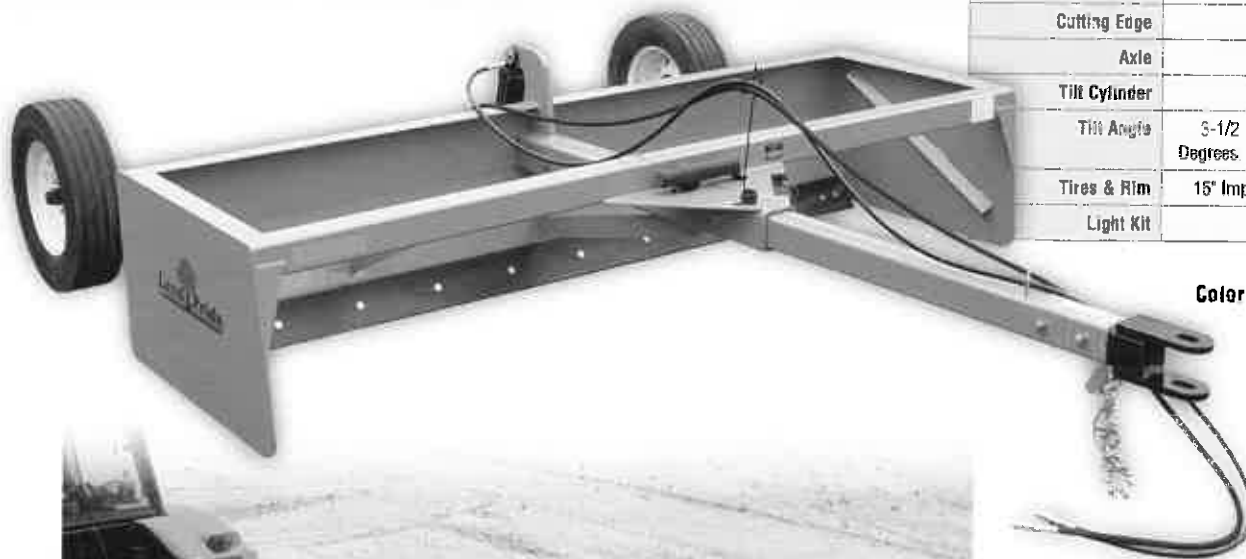

Color Options:

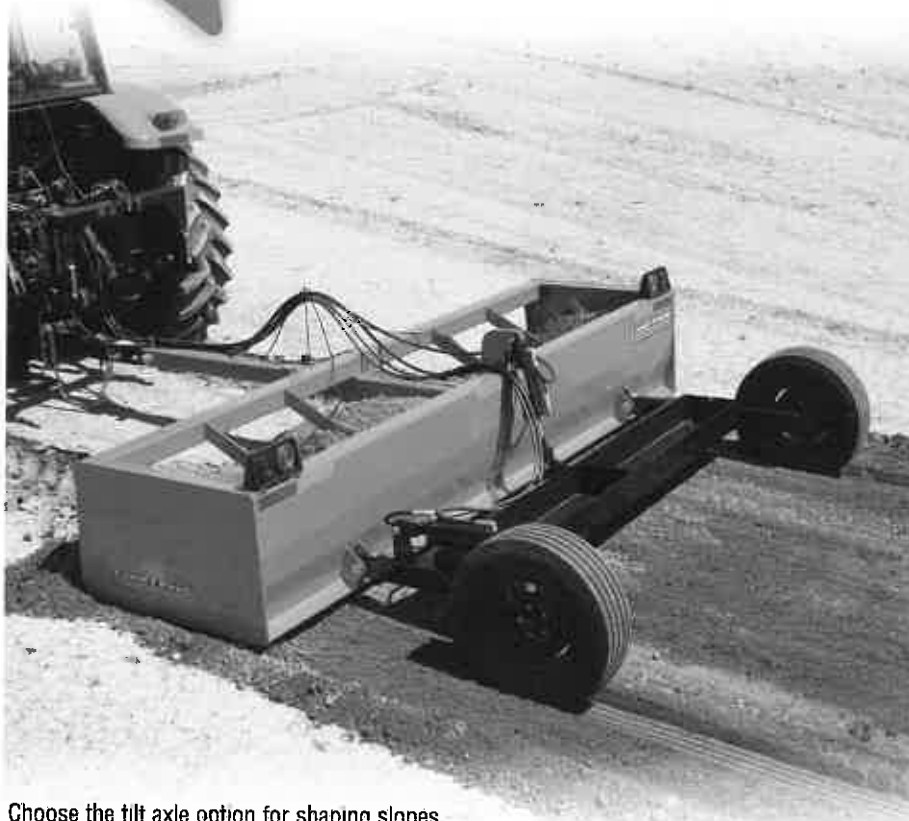

Vertical gussets for superior strength under side loads.

- 4" x 4" Square tubing main beam and tongue
- 5" Maximum cutting depth can load the bucket quickly
- Optional tilt allows deep angle cuts in one pass
- Optional weight tray can be filled with 760 lbs. of concrete for additional weight when scraping and moving material

Choose the tilt axle option for shaping slopes, terracing or ditching. The tilt cylinder will raise one side of the drag scraper approximately 8" (7" on BB4596).



## A low cost alternative for road grading applications.

The GS15 Series Grading Scrapers are ideal for landscaping, small farms and ranches, hunting camps, large estates, small acreages, and sod farms. The GS25 Series are ideal for renovating gravel driveways and roads, leveling construction and turf sites, and cleaning barns and chicken coups.

Unlike a box scraper, they are not designed to transfer large volumes of dirt from one location to another and as a result do not require the additional horsepower that a box scraper requires. Nor does it require the tending of tractor 3-point lift controls to maintain grade that a box scraper might also require. Simply setting a properly adjusted GS15 or GS25 Series Grading Scraper on the ground and driving forward enables the operator to grade off high spots and fill in ruts and low spots on unimproved roads and lanes with little or no manipulation of the tractors 3-point hitch controls. Unlike a rear blade, they require no adjustment of blade angling or offset positions.

The GS15 and GS25 Series Grading Scrapers simply and quickly move dirt or aggregate from high spots to low spots making them extra user-friendly and a low cost alternative for road grading applications.



Rear cutting blades available as an accessory.



	GS1540	GS1560	GS1572	GS2564	GS2596
<b>Horsepower</b>	20-50 HP	25-50 HP		40-90 HP	
<b>Hitch</b>	Cat 1			Cat 1 & 2	
<b>Working Width (cm)</b>	48" (122)	60" (152)	72" (184)	84" (213)	96" (244)
<b>Side Panel Thickness</b>	3/16" Thick with 2-3/4" Formed Edges			1/4" Thick with 2-3/4" formed edges	
<b>Front Main Beam &amp; Scarifier Support</b>	4" x 4" x 5/16" Reinforced Heavy Wall Tubing; 2" x 2" x 3/16" Heavy Wall Tubing			4" x 4" x 5/16" Reinforced Heavy Wall Tubing; 3" x 3" x 3/16" Heavy Wall Tubing	
<b>Skid Shoe Dimensions</b>	3/8" Thick x 2-3/4" Wide x 44" Long			3/8" Thick x 2-3/4" Wide x 50-1/4" Long	
<b>Scarifier Shank Construction</b>	Heat Treated 4-Position Shank with Dimpled-on Hardened Tips				
<b>Cutting Edges</b>	Two 1/2" x 6" High Carbon Heat Treated Blades, Reversible & Replaceable				
<b>Cutting Edge Adjustment</b>	Infinite Vertical Adjustment from Level Grade to 1-1/2" Below Grade				
<b>Weight - lb (kg)</b>	437 (198)	511 (232)	594 (269)	796 (361)	864 (392)

Color Options:



## Add hydraulic power with ease.

The HRS is a self contained power pack to run log splitters, chippers, front-mounted snowblowers and more. Easily hook to the 3-point hitch on your tractor, hook the driveline to the tractor's PTO shaft, and you have a convenient supply of hydraulic power.



	HRS3025
Horsepower	52 Min.
Hitch	Cat. 1 & 2
Pump Capacity	Approx 25 GPM @ 540 RPM
PTO Input Speed	540 RPM
Hydraulic Fluid Type	Mobil Fluid 424
Overload Protection	Hydraulic Relief Valve
Reservoir Capacity & Filter Type	35 Gallons, Conventional 10 Micron Filter
Overload Protection	3000 PSI Hydraulic Relief Valve
Driveline	ASAE Category 2
Pressure & Return Hoses Lengths	24 Feet Each
Case Drain Port	3/4" - 16 UNF
Hydraulic Cooler	Optional

Color:



### Optional Valve Selections

- No Valve - Use PTO to turn hydraulics on and off
- Manual Valve - Use remote valve to turn hydraulics on and off
- Solenoid Valve - Use electronic control to turn hydraulics on and off
- Add hydraulic power to your tractor to power front mounted hydraulic driven implements
- Can also be used to power independent implements such as a log splitter





## The essential tool for landscapers.

As America's premier supplier of Landscape Rakes, Land Pride offers light-duty through construction-grade models. Designed for raking rocks, dirt, sand, landscaping and construction debris, our rakes are the landscaper's perfect tool to clean and prepare a site for seeding as well as general maintenance around farms, parks and beaches.



LR1696



LR0560

	LR0560	LR0560	LR1660	LR1672	LR1684	LR1696
<b>Horsepower</b>	15-20 HP		20-40 HP			
<b>Hitch</b>	Cat. 0 w/Cat. 1 Pins. Cat. 1 Limited		Cat. 1			
<b>Working Width (cm)</b>	48" (122)	60" (152)	60" (152)	72" (183)	84" (213)	96" (244)
<b>Angle/Position</b>	5 Forward Up to 30°		7 Forward Up to 45°			
<b>No. of Teeth</b>	26	34	30	36	42	48
<b>Teeth Spacing</b>	1-3/4" Centers		2" Centers			
<b>Teeth Material</b>	High Carbon Spring Steel		High Carbon Spring Steel			
<b>Tooth Size</b>	1/4" x 3/4"		5/16" x 1"			
<b>Rake Height</b>	12"		16-1/2"			
<b>Weight - lb (kg)</b>	98 (44)	113 (51)	241 (109)	270 (122)	291 (132)	316 (143)
<b>Options</b>	N/A		Dual Gauge Wheels 13" x 4" x 6" or 13" x 6.5" x 6" Flip-Down Grader Blade (Must be Used in conjunction with Dual Gauge Wheels)			

Color Options:



LR16 Only





LR3696

**A versatile tool for landscapers, cities, parks, and other recreational areas.**

**Heavier grades for heavier jobs. Spread rock, gather pine needles, or prepare a seedbed.**

The LR26 and LR36 Series Landscape Rakes are ideal for spreading rock, moving debris, preparing seed beds, and reshaping soil and/or aggregate profile. The LR26 is designed for tractors up to 60 HP and features a quick-hitch compatible Cat. 1 Hitch and can be ordered with an optional hydraulic angling kit, while the LR36 is designed for tractors up to 80 HP with Cat. 1 or 2 hitch and is also quick-hitch compatible. Available accessories include single or dual gauge wheels and flip down grader blades.

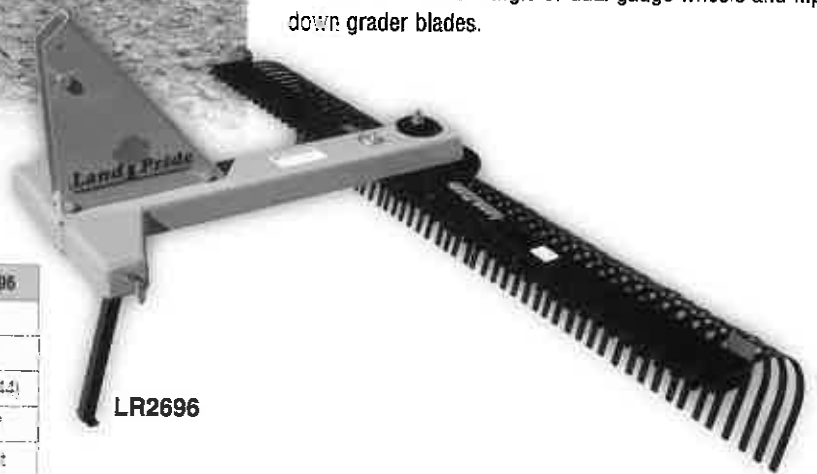

LR2696

	LR2684	LR2996	LR3684	LR3696
<b>Horsepower</b>	25-60 HP		30-80 HP	
<b>Hitch</b>	Cat 1		Cat 1 or 2	
<b>Working Width (cm)</b>	84" (213)	96" (244)	84" (213)	96" (244)
<b>Angle/Position</b>	7 Forward Up to 45°		6 Forward Up to 30°	
<b>Offset</b>	N/A	N/A	45° Swing, 24° Offset Manual or Hydraulic	
<b>No. of Teeth</b>	42	48	42	48
<b>Teeth Spacing</b>	2" Centers		2" Centers	
<b>Teeth Material</b>	High Carbon Spring Steel		High Carbon Spring Steel	
<b>Tooth Size</b>	5/16" x 1"		5/16" x 1"	
<b>Rake Height</b>	16-1/2"		16-1/2"	
<b>Weight - lb (kg)</b>	330(150)	348 (158)	480 (209)	483 (219)
<b>Options</b>	Dual Gauge Wheels 13" x 4" x 6" or 13" x 6.5" x 6", Flip-Down Grader Blade, Hydraulic Angle Cylinder		Dual Gauge Wheels 13" x 4" x 6" or 13" x 6.5" x 6", Flip-Down Grader Blade	

Color Options:



## Renovate and reshape.

Land Pride's SF25 Series Scarifiers perform severe ripping, loosening, renovation, and reshaping of the soil profile. Both models are designed for tandem attachment and will work in unison with Land Pride 15, 16, and 26 Series Landscape Rakes or Rear Blades. The versatile action of a Land Pride Scarifier, paired with a Rake or a Blade, makes them perfectly suited for use by landscapers, contractors, and rental yards.

	SF2566	SF2577
Horsepower	25-50 HP	
Hitch	Cat. 1	
Working Width (cm)	60" (152)	72" (183)
Width (cm)	66" (168)	77" (196)
Weight - lb (kg)	208 (94)	235 (107)
No. of Shanks	6	7
Shank Type	3/4" x 2-1/2" Heat Treated, Spring Steel Dimpled-On Tips	

Color Options: 

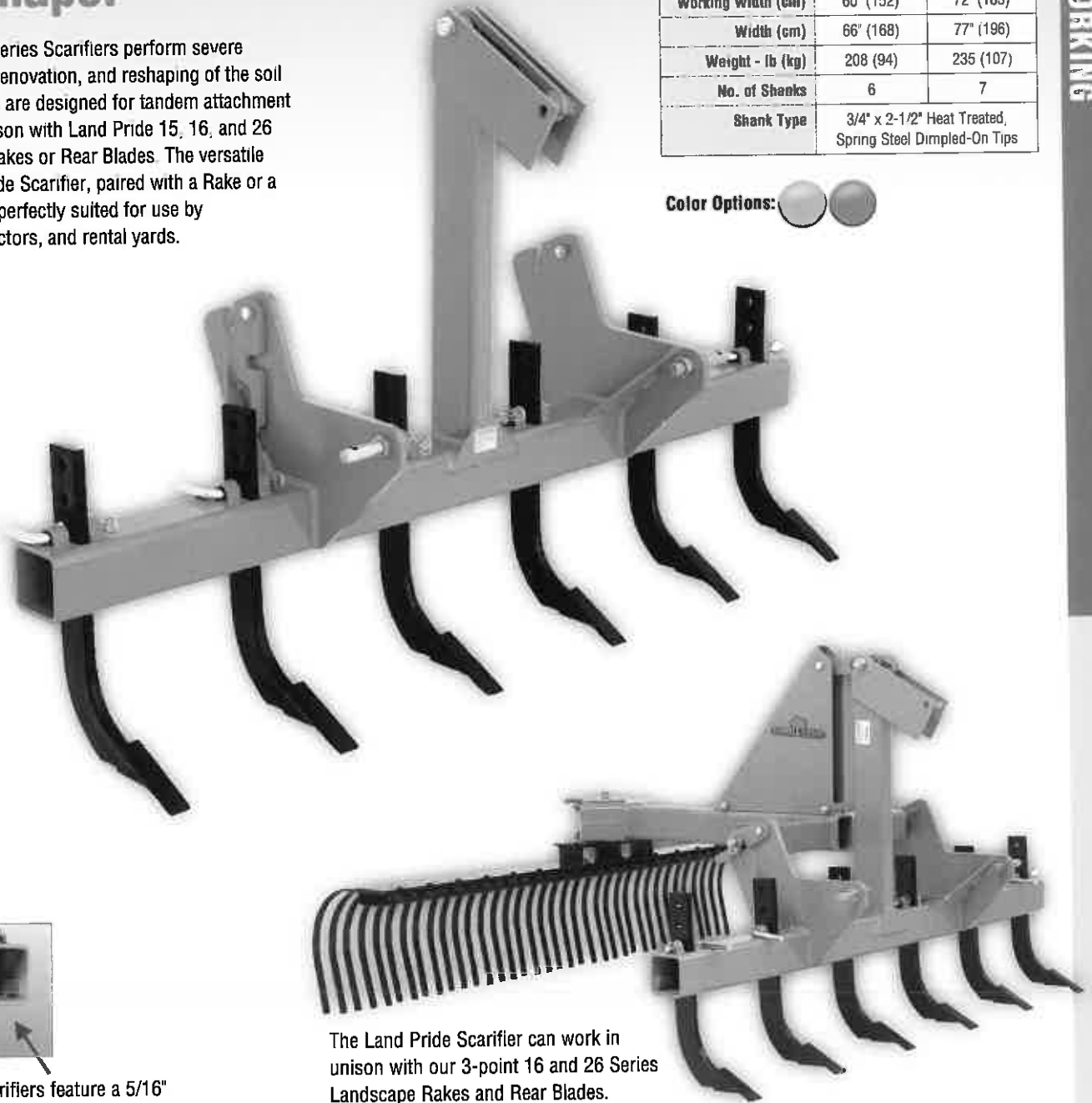

All Land Pride Scarifiers feature a 5/16" wall thickness on the shank tube for high tensile strength, and a 5/16" x 1" full length reinforcement bar.

The Land Pride Scarifier can work in unison with our 3-point 16 and 26 Series Landscape Rakes and Rear Blades.

Designed with a twist to lift while fracturing the soil sideways.

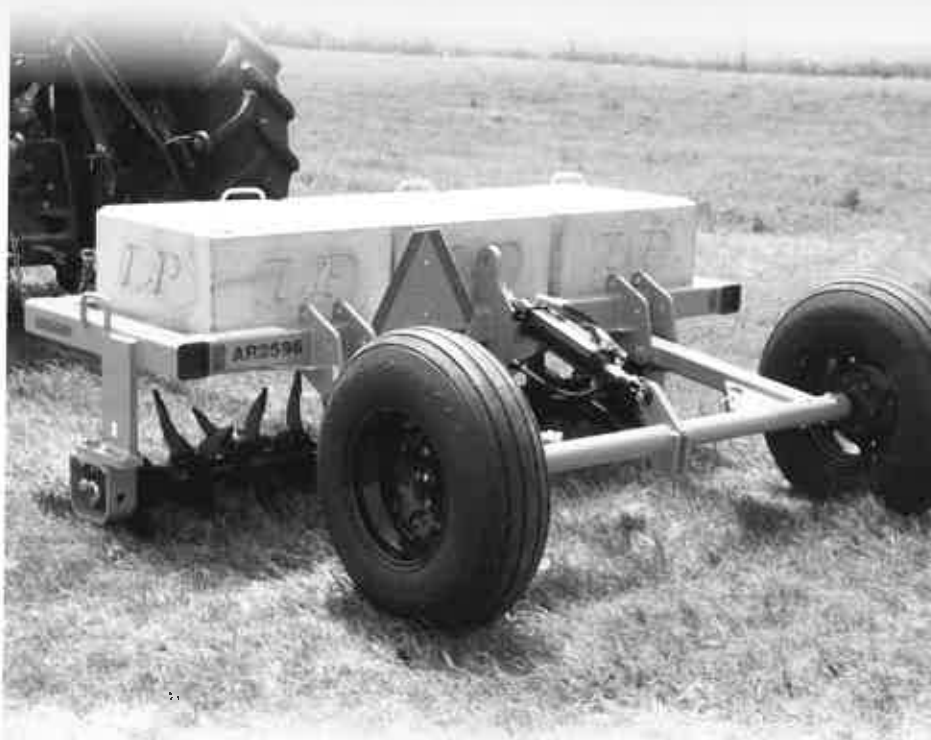

Land Pride's AR25 Series pull-type Pasture Aerators are ideal in agricultural conservation tillage and pasture renovations. The heavy-duty, knife-like tines on the aerator are designed with a twist in them to break-up compacted soil horizontally and vertically as they slice into the ground in a twisting fashion. This breaking action conditions the soil to soak up run-off water faster, allow fertilizer to penetrate deeper into the ground, and increase oxygen and water supplies to the plant roots.

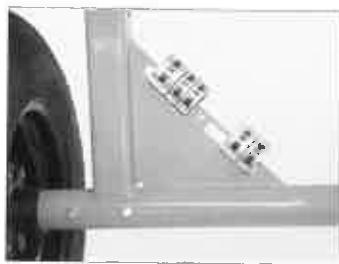

Cylinder stops storage area.



	AR2596	AR2510
Horsepower	40-90 HP	
Hitch	Pull-type	
Working Width (cm)	7'2" (218)	9'8" (285)
Overall Length	10'11"	
Clevis	Double Tang	
No. of Tines	48	64
Rotor Angle	2-1/2, 5, 7-1/2 Degrees, 2 Bolt Adjustment	
Tine Spacing	7-1/2"	
Bearings	Triple Lip Seal and Heavy Duty Bearing Hanger	
Tire Size	9.5Lx15-8 Ply	
Wheel Hub	6 bolt	
Optional Weights	Up to 3 - 740 lbs Each	Up to 4 - 740 lbs Each

Color Options:



- 8" Maximum tine penetration for aerating the soil
- 9' Forged & heat treated through steel tines are very resistant to wear and breakage giving them a long life
- Heavy duty rotary tine hangers are designed to stand up to the rigors of hard rocky soil
- Optional concrete weights help aerator tines penetrate the ground

# PD10/15 POST HOLE DIGGERS

HP  
15-40

HITCH  
Cat. 1

## Two sizes: Perfect for DIY!



The PD10 and PD15 Series Post Hole Diggers are just right for 3-point attachment to Cat. 1 subcompact utility tractors. These units offer a 30" or 48" auger length and a choice of 6", 9", & 12" auger flights with cast steel fishtail tips for quick piloting and faster hole starting. Landscapers, rental yards, contractors, farmers, ranchers, and homeowner will find that the PD 10 or the PD15 meets their general duty needs and applications.



### Storage Stand

Manhandling a Post Hole Digger by yourself is next to impossible. With our innovative Post Hole Digger stand, one person hook and unhook becomes a reality!

## SUBCOMPACT TRACTORS

	PD10
Horsepower	15-30 HP
Hitch	Cat 1
Yoke (cm)	2-7/8" (7.30) Tubing
Boom (cm)	2-7/8" (7.30) Tubing
Output Shaft (cm)	2" (5.08)
Input RPM	540 Tractor at 300 RPM
Driveline	Category 2
Component Protection	Shear-Bolt
Max Auger RPM	96
Auger Length	30"
Auger Sizes	6", 9" or 12"
Fighting Thickness	1/4"
Options	Hydraulic Cylinder Down Pressure Kit (Applies approx. 500 lbs of Force)*, Auger Alignment Handle, Storage Stand

See dealer for complete warranty information.  
\*May not work in some cab applications.

Color Options:



	PD15
Horsepower	20-40 HP
Hitch	Cat 1
Yoke (cm)	2-7/8" (7.30) Tubing
Boom (cm)	2-7/8" (7.30) Tubing
Output Shaft (cm)	2" (5.08)
Input RPM	540 Tractor at 300 RPM
Driveline	Category 2
Component Protection	Shear-Bolt
Max Auger RPM	94
Auger Length	48"
Auger Sizes	6", 9" or 12"
Fighting Thickness	1/4"
Options	Hydraulic Cylinder Down Pressure Kit (Applies approx. 500 lbs of Force)*, Auger Alignment Handle, Storage Stand

See dealer for complete warranty information.  
\*May not work in some cab applications.

Color Options:



DIRTWORKING



## Additional power for those tougher jobs.



Land Pride PD25 and PD35 Series Post Hole Diggers are a good fit for heavy-duty applications. Landscapers, contractors, ranchers, and other land owners will appreciate the rugged dependability and the quality construction – these PDs will take a beating and last for years. Both are designed for Category 1 or 2 three-point attachment, offer a 48" auger length, and a choice of 6", 9", 12", 15", 18" or 24" auger flights with cast steel fishtail tips.

	PD25	PD35
<b>Horsepower</b>	25-55 HP	30-75 HP
<b>Hitch</b>	Cat. 1 or 2	
<b>Yoke (cm)</b>	2-7/8" (7.30) Tubing	
<b>Boom (cm)</b>	3-1/2" (8.89) Reinforced Tubing	
<b>Output Shaft (cm)</b>	2" (5.08)	
<b>Input RPM</b>	540 Tractor at 300 RPM	
<b>Driveline</b>	Category 3	
<b>Component Protection</b>	Shear-Pin or Radial Pin**	
<b>Max Auger RPM</b>	94/75	
<b>Auger Length</b>	48"	
<b>Auger Sizes*</b>	6", 9", 12", 15", 18" or 24"	
<b>Flighting Thickness</b>	1/4"	
<b>Options</b>	7" or 14" Auger Extension Hydraulic Cylinder Down Pressure Kit** (Applies approx 500 lbs of Force) Auger Alignment Handle, Storage Stand	

See dealer for complete warranty information.

\*Radial Pin recommended on auger sizes of 15" and above.

\*\*May not work in some cab applications.

Color Options:



Cast steel teeth are replaceable, and positioned for maximum digging performance.

The economical answer to your post hole needs.



### MOUNTING OPTIONS

The HD25 and HD35 Post Hole Diggers are available with a skid steer mount, a hydraulic driven, 3-point tractor mount, or a bucket mount.



The HD25 and HD35 Series Post Hole Diggers are hydraulically driven and accommodate augers ranging from 6" to 24" in diameter. They are available with a skid steer mount, a bolt-on mount for mounting to the side of a bucket on a tractor front-end loader, or with a boom for mounting to a category 1 or 2 three-point hitch, and meet the heavy duty needs of nurseries, landscapers, contractors, construction companies, ranchers, and land managers. The HD35 will deliver up to 1,605 ft.lbs of torque when industrial-duty is preferred. You can also reverse the auger direction, easing the strain on the auger when extracting it from the ground. Available in HD25 or HD35 Series.

	HD25	HD35
Hydraulic GPM Range	5-12 GPM	10-25 GPM
Hitch	Cat 1 or 2, or Front Loader Bucket Mount	
Yoke (cm)	2-7/8" (7.30) Tubing	
Boom (cm)	3-1/2" (8.89) Reinforced Tubing	
Output Shaft (cm)	2" (5.08)	
Drive	Hydraulic	
Hydraulic Hose	Standard on 3-Point, 2 Each 24' Length on Bucket Mount	
Max Auger RPM	101	93
Auger Length	48"	
Auger Sizes*	6", 9", 12", 15", 18" or 24"	
Flighting Thickness	1/4"	
Options	Hydraulic Cylinder Down Pressure Kit on 3-Point*, 3-Pt Storage Stand, 7" or 14" Auger Extension, QA Mount w/8' or 24' Hoses	

See dealer for complete warranty information.

\*Radial Pin recommended on auger sizes of 15" and above.

\*\*May not work in some cab applications.

3-Point

Color Options:



Land Pride offers a variety of augers ranging from 6" - 24", with a 36" tree auger also available for the SA35 Series.





## The ideal tool for seedbed preparation.

Land Pride's PR16 Series Powered Rake is a multi-functional seed bed and soil surface preparation tool for landscapers and turf care professionals. Capable of grading, leveling, shaping, cultivating, renovating, and pulverizing various types of soil surfaces. They are also capable of raking or windrowing soil, rocks, and construction site debris. The 60" or 72" working widths are a good choice for smaller landscaping and turf renovation jobs, while the 90" model is perfect for larger commercial jobs.

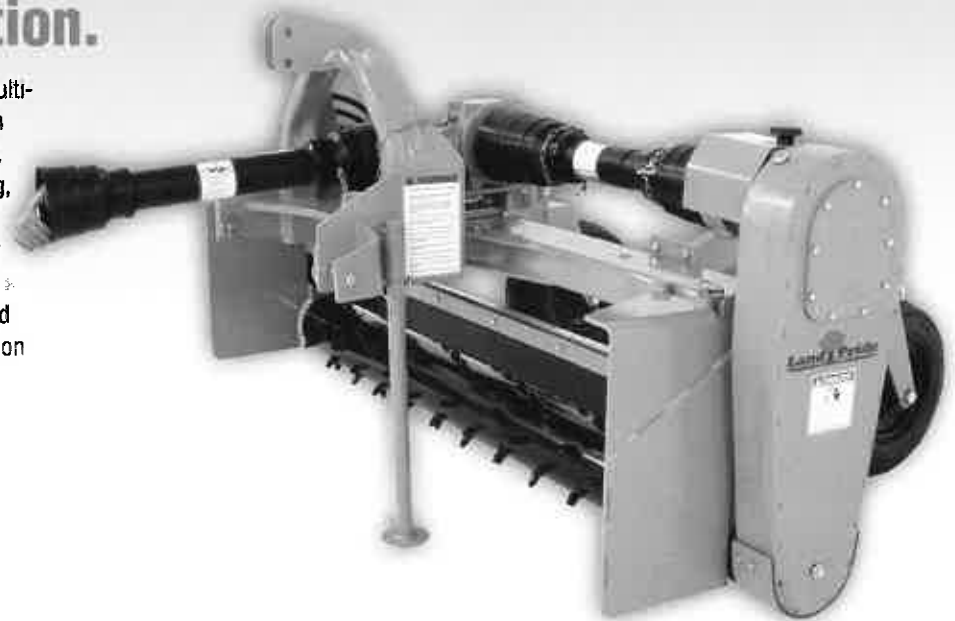

	PR1660	PR1672	PR1690
<b>Horsepower</b>	25-40 HP		35-75 HP
<b>Hitch</b>	Cat. 1		Cat. 1 or 2
<b>Working Width (cm)</b>	80" (182)	72" (183)	90" (228)
<b>Gearbox</b>	540 RPM Ball Bearings, Cast Iron Housing, Drain Plug		
<b>Primary Driveline</b>	Cat. 5 Heavy-Duty		
<b>Secondary Driveline</b>	Cat. 3 with Slip-Clutch		
<b>Material Control Deflector</b>	1/2" x 5" Hard Urethane		
<b>Roller</b>	9-3/8" Diameter, w/ 3/4" x 1-1/2" Carbide Tipped Studs		
<b>Drive Chain</b>	#60 Double Continuous Roller Cham, High Tensile, Enclosed in Oil Bath		
<b>Angle Adjustment</b>	15° Left and Right - Hyd. or Manual		
<b>Angle Cylinder</b>	2" x 8"		
<b>End Plates</b>	Standard		
<b>Gauge Wheels</b>	60 13" x 6.5" 72 & 90 16.5" x 6.5" Air Tires with Sealant and 3/4" Roller Bearings and Spacer Height Adjustment		
<b>Skid Shoes</b>	Replaceable		
<b>Machine Weight - lb (kg)</b>	980 (445)	1,000 (454)	1,150 (522)

See dealer for complete warranty information.

Color Options:



## Engineered for Sub-compact Tractors.

Land Pride's new QH05 Quick Hitch is specifically engineered for sub-compact tractors. The QH05 allows you to quickly connect to or disconnect from over 20 Land Pride products – most without leaving the tractor seat. Owners of sub-compact tractors will find that the Land Pride QH05 speeds implement changes, allowing more time to get chores completed.



*\*The QH05 does not increase the lifting capacity of your sub-compact tractor. Refer to your tractor owner's manual for lifting capacity.*



QH05

\*Patents Pending



For a complete list of compatible Land Pride implements, scan QR code or visit [landpride.com/QH05](http://landpride.com/QH05)

## The True Timesavers.

Our Quick-Hitch Systems, designed in accordance with ASAE specifications, fit most Land Pride products and are a real time saver when working on multiple projects. Look for this Quick-Hitch System logo to denote applicable products throughout our product line.



	QH05	QH15	QH20
3-Point Hitch	Cat. 1, Sub-Compact*	Cat. 1	Cat. 2
Overall Width (cm)	32-5/8" (81)	32-5/8" (81)	40" (102)
Overall Height	20-1/4"	23-1/4"	23-5/8"
Overall Length	6-1/2"	9"	8-7/8"
Weight lbs (kg)	37 (17)	70 (32)	120 (54)
Automatic Lock	Auto Lock with Quick Release		
Optional	Floating Top Link Attachment Optional		



QH15

QH20

\*PTO driven implements may need a longer driveline. Please consult our Service & Parts Department for longer profile availability.

Color: 



Implement hitch

An optional link is available for implements that have a swiveling top link.



## Ideal for leveling and seedbed preparation.

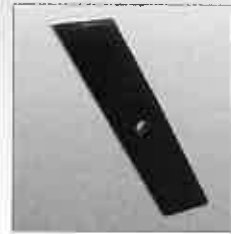
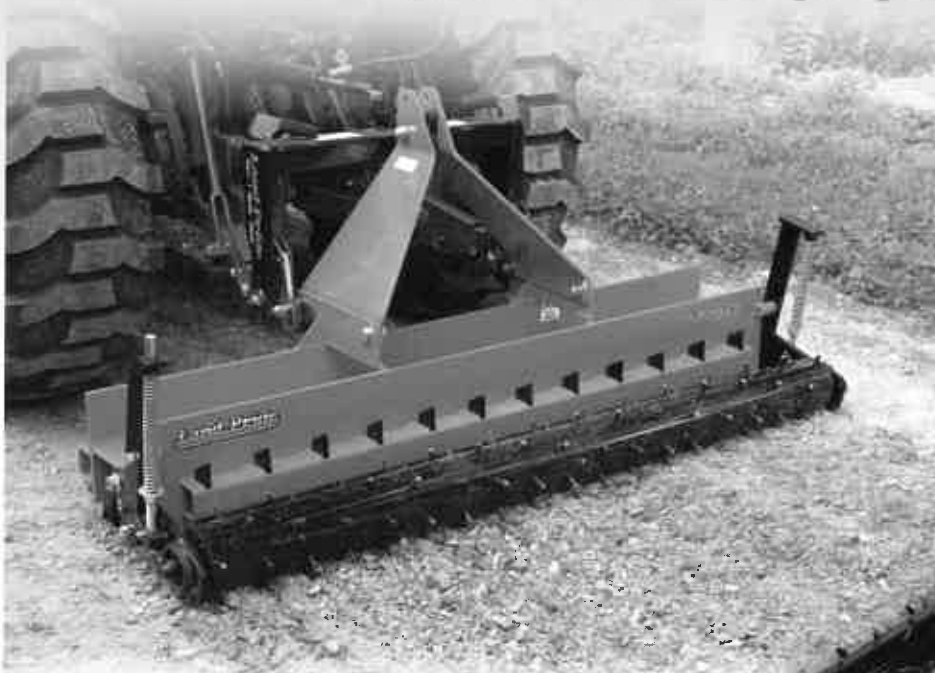

**Aggressive Reversible Scarifier Shanks**  
10 1/2" x 2" x 1/2" Scarifier shanks aggressively rip crusted soils, enabling the steel spiked roller to break down the soil to a perfect consistency ready for planting.

3/8" Steel spikes are welded to the roller's surface and feature replaceable wear sleeves.

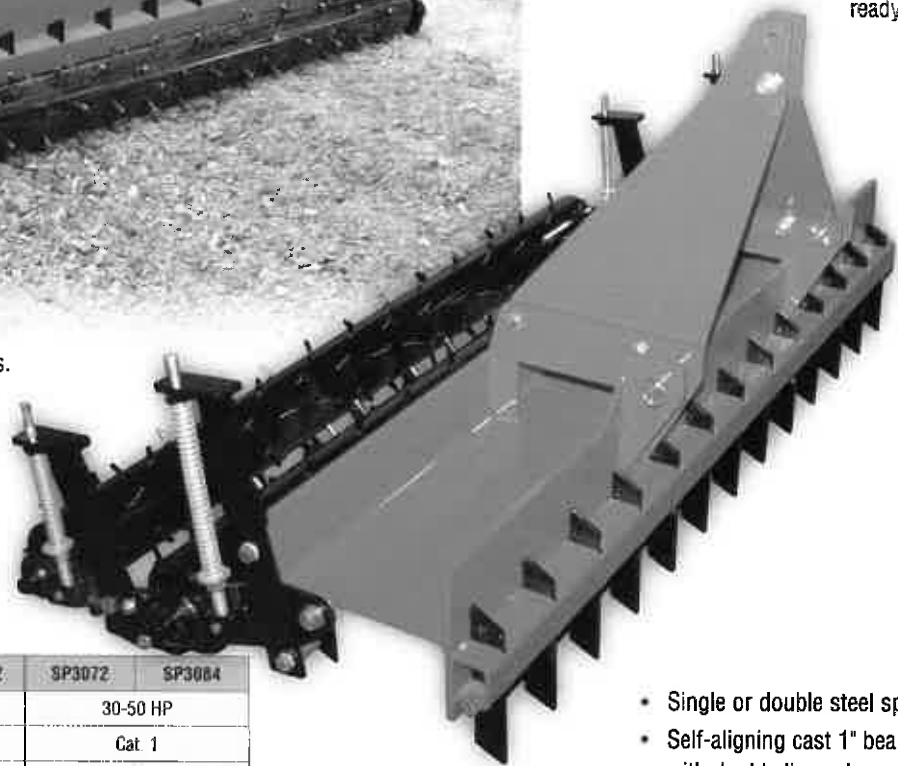

	SP2060	SP2072	SP3072	SP3084
<b>Horsepower</b>	25-35 HP		30-50 HP	
<b>Hitch</b>	Cat 1		Cat 1	
<b>Working Width (cm)</b>	60" (152)	72" (182)	72" (182)	84" (213)
<b>H-Beam</b>	10"		12"	
<b>Weight - Sgl Roller - lb (kg)</b>	491 (223)	561 (255)	671 (305)	721 (328)
<b>Front to Back Length - Single Roller</b>	25-1/2"		28-1/4"	
<b>No. of Scarifier Shanks</b>	21	25	25	28
<b>Shank Spacing</b>	2-13/16"		2-13/16"	
<b>No. of Spikes on Sgl Roller</b>	86	103	103	116
<b>No. of Spikes on Dbl Roller</b>	N/A	N/A	206	232
<b>Spiked Roller Tube Diameter</b>	5-9/16" O.D.		6 5/8" O.D. Optional 2nd Roller 5-9/16"	
<b>Roller Spike Material</b>	3/8" x 1-1/4" Steel, Replaceable Heat Treated		3/8" x 1-1/4" Steel, Replaceable Heat Treated	
<b>Springs</b>	32 lbs/inch		Front Roller: 32 lbs/inch Rear Roller: 5 lbs/inch	

- Single or double steel spiked roller
- Self-aligning cast 1" bearings with double lip seals
- 1" Diameter shaft in roller

Color Options:



# STH15/20 SPIKE TOOTH HARROWS

HP  
20-45+

HITCH  
Cat. T & Pull-Type

## Renovate, aerate, or rake.

The STH15 Series Spike Tooth Harrow cuts through clods, manure, and grasses to break up material into finer pieces so that it can be spread evenly across the ground. This harrow does an excellent job of smoothing garden plots, fields, arenas, and landscaping areas.

It loosens crusted soil, aerates legume crops such as alfalfa, and uncovers overwintering insects.

	STH1500	STH2000
Horsepower	20-45 HP	45 HP Min
Hitch	Cat. 1	Pull-type
Working Width (cm)	7'6" (229)	23'7" (719)
Transport Width	7'6"	8'6"
Transport Height	35-3/4"	8'8"
Transport Length	53"	15'
Field Length	53"	23'
Weight (kg)	224 (102)	2,100 (907)
Transport Tongue Weight	N/A	432 (196)
Tooth Spacing	9"	9"
Teeth on Ground (per foot)	7	12
Tooth Size	Diamond Shaped Forge Hardened 6" x 2-1/2"	Diamond Shaped Forge Hardened 6" x 2-1/2"
No. of Teeth	50	244
Tooth Angle	10 Different Angles	22 or 40 Degrees
Bars	5	8
Bar Material	1-11/16" OD	1-11/16" OD
Wing & Transport Tires	N/A	205R15
Hydraulic Fold	N/A	Standard

Color Options:



Quick Hitch

STH15 Only

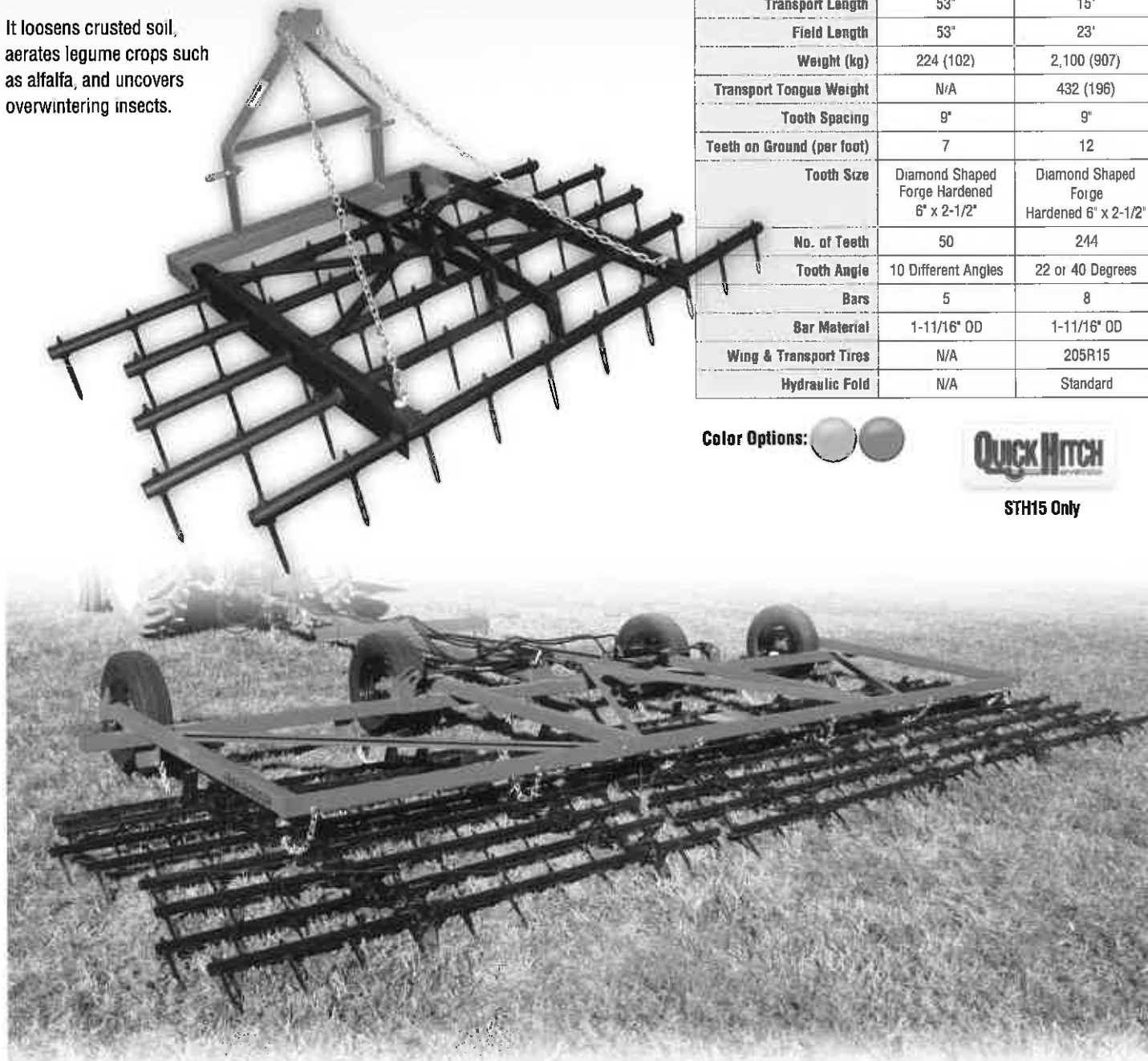

The STH20 Series Spike Tooth Harrow can be used to spread manure, grass clippings, leaf litter, previous crop stubble, and gravel driveways; it can better incorporate fertilizers, herbicides, granular products, and broadcast seed into the soil. It also helps to remove gopher mounds, ant hills, ridges from tillage implements, sticks, and small limbs from grassy areas.

Land Pride

## Quickly turn limbs into mulch or to aid in decomposition.



**WC1503**

Land owners can utilize Land Pride's WC1503 3-point mounted Wood Chipper to quickly turn mountains of limbs into chips for mulch or just to aid in decomposition. Driven by the tractor's PTO, this unit features a self-feeding 3" cutting capacity, two reversible and replaceable hardened-steel knives, adjustable discharge chute, and dual B-section drive belts.

The WC1504 features a self feeding 4" cutting capacity, 4 reversible and replaceable hardened steel knives and adjustable discharge chute. The WC1504 features direct drive to the rotor. Both models offer adjustable support stands to better match your tractor.

Adjustable support stands help elevate the Wood Chipper to match the height to your tractor's output shaft, enabling the driveline to remain straight and level.



Adjustable discharge spout rotates 270 degrees.

	WC1503	WC1504
<b>Horsepower</b>	12-30 HP Min. 25 HP for Max. Capacity	20-50 HP Min. 35 HP for Max. Capacity
<b>Hitch</b>	Cat. 1 Quick-Hitch Compatible	
<b>Upper Hitch Plate Thickness</b>	1/4"	5/16"
<b>Main Frame Thickness</b>	3/16"	
<b>Weight - lbs (kg)</b>	369 (167)	450 (204)
<b>Rotor Housing Thickness</b>	3/16"	
<b>PTO Speed</b>	540 rpm	
<b>Driveline Category</b>	Cat. 2 Shear-bolt	Cat. 4 Shear-bolt
<b>Main Drive Pulley Diameter</b>	16.35"	N/A-Direct Drive
<b>Rotor Pulley Diameter</b>	4-1/2"	N/A-Direct Drive
<b>Belts</b>	2 Single B section	N/A-Direct Drive
<b>Belt Tensioner</b>	Spring Loaded w/ Adjustment	N/A-Direct Drive
<b>Rotor Size</b>	17-1/2"	25"
<b>Rotor Speed</b>	1984 rpm	540 rpm
<b>Chip Capacity</b>	3"	4"
<b>Hopper Inlet Opening</b>	14" x 15"	20" x 20"
<b>Chipper Inlet Opening</b>	8" x 3"	10" x 4"
<b>Spout Discharge Opening</b>	3-1/4" Square	5-1/4"
<b>Cutting Knife</b>	Reversible and Replaceable	
<b>Number of Knives</b>	2	4
<b>Knife Size</b>	2-1/2" x 2" x 1/4"	6" x 2" x 1/4"
<b>Knife Material</b>	Hardened Steel	
<b>Feed System</b>	Self Feed	
<b>Feed Height Above Ground</b>	35" (No Skids)	24"-30" w/ Adjustable Support Stands
<b>Chip Chute Position</b>	270 Degrees	

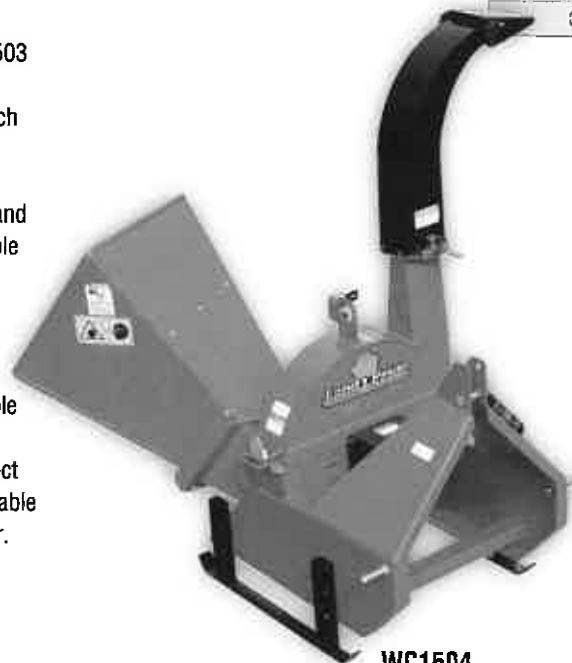

**WC1504**

Color Options:



Knives are reversible and replaceable.



## Quickly handle big jobs.

Move brush, clean stalls, lift debris and so much more with Land Pride's SGC0548 Claw Grapple. The SGC05 will make chores a breeze. Easily grasp, lift, and move a variety of materials making property maintenance easier and less time consuming.

Our SGC05 tines are manufactured from high-tensile AR400 Steel to make sure it stands up to demanding use. For added strength, the frame is made of 2" x 3" rectangular tubing. And it carries the Land Pride name, so you know quality is built in.



	SGC0548
<b>Mount</b>	Kubota BX Quick Hitch System or pin direct to loader arms
<b>Width</b>	48"
<b>Weight - lbs (kg)</b>	156 (71)
<b>Closed Height</b>	26-1/2"
<b>Number of Bottom Teeth</b>	6
<b>Number of Top Teeth</b>	5
<b>Teeth Spacing</b>	9-3/8"
<b>Tooth Thickness</b>	1/4"
<b>Working Length of Teeth</b>	8-3/8"
<b>Jaw Opening</b>	30"
<b>Tine Material</b>	AR400

Color: 



Land Pride 3rd Function Valve accessory kit adds versatility to your tractor. (380-137A)



Convenient Park Stand provides stability while storing, simplifying attachment and detachment.



The frame is built from 2" x 3" rectangular tubing for added strength.





## Make quick work of large jobs.

Land Pride's Claw Grapple makes quick work of large jobs. The SGC can be used to rake, dig, and move rocks, trees, brush, and construction debris without picking up dirt. The compact design minimizes weight while preserving lift capacity. This unit comes complete with the durability that Land Pride is known for. Our Claw Grapple is ideal for an all-purpose grapple.



All pivot points feature 1-1/4" greasable pins.



6" x 6" Frame tube for strength and serrated teeth keep material from rolling out.



The 10 & 20 Series Claw Grapples feature AR400 teeth construction. This abrasion resistant steel has a tensile strength five times that of A36 steel. For heavy use in varied extreme conditions, the SGC10 & SGC20 allows for a longer life. The AR400 also possesses additional 'memory'; allowing bent teeth to potentially spring back into position.

	SGC1060	SGC1072	SGC1560	SGC1572	SGC1584	SGC2060	SGC2072	SGC2084
<b>Hitch</b>	Front Loader Plate, Kubota B Mount, or Blank*		Skid/Loader Plate			Skid/Loader Plate		
<b>Width</b>	32"	35"	63"	74"	86"	63"	74"	86"
<b>Weight - lbs (kg)</b>	358 (161) <small>w/o hitch</small>	414 (188) <small>w/o hitch</small>	784 (356)	882 (400)	987 (448)	798 (362)	895 (406)	922 (433)
<b>Closed Height</b>	33"		39"			39"		
<b>Number of Bottom Teeth</b>	10	12	10	12	14	10	12	14
<b>Number of Top Teeth</b>	9	11	9	11	13	9	11	13
<b>Spacing of Teeth</b>	6"		6"			6"		
<b>Tooth Thickness</b>	1/2" Outer, 3/8" Inner		1/2"			1/2"		
<b>Working Length of Teeth</b>	11-1/4"		12-7/8"			14-3/4"		
<b>Hydraulic Cylinder</b>	2" x 8" x 1-1/8" Rod		3" x 10" x 1-1/4" Rod			3" x 10" x 1-1/4" Rod		
<b>Jaw Opening</b>	38-3/4"		50"			50"		
<b>Tina Material</b>	High Tensile AR400		Grade 80			High Tensile AR400		

Color:

\*For Dealer Installed Hitch Plate



## Designed to do the dirty work!

The Land Pride Rock Grapple is designed to do the dirty work. Built in 66", 72" and 78" widths, this grapple allows you to move volumes of material quickly and efficiently. SGR15 Grapples feature dual hydraulic cylinders that can close at various gaps to handle irregular shapes, and the bucket is designed with 3" spacing between the teeth to allow small rocks, soil, and other debris to be sifted, leaving the larger material locked in its jaws. The SBR15 has the same bucket as the SGR15, but without the top Grapple.



3" Teeth spacing sifts dirt and other small debris.



Dual grapples provide a firmer grasp on irregular loads.



**SBR15**

Color:

	SBR1566	SBR1572	SBR1578	SGR1566	SGR1572	SGR1578
Hitch	Skid/Loader Plate Mount			Skid/Loader Plate Mount		
Width	66"	72"	78"	66"	72"	78"
Weight - lbs (kg)	855 (388)	904 (410)	938 (425)	509 (231)	550 (249)	594 (269)
Closed Height	31"			N/A		
Number of Bottom Teeth	21	23	25	21	23	25
Spacing of Teeth	3"			3"		
Tooth Thickness	3/8"			3/8"		
Working Length of Teeth	38"			38"		
Hydraulic Cylinder	2" x 8" x 1-1/4" Rod			N/A		
Jaw Opening	37"			N/A		
Lower Tine Material	Grade 80			Grade 80		

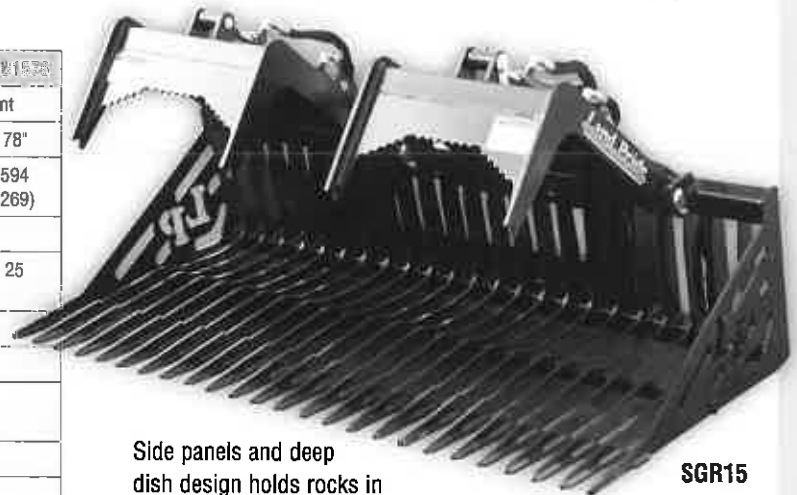

**SGR15**

Side panels and deep dish design holds rocks in rear of bucket while digging.



## Ideal for storm clean-up and land clearing operations.

Let the Land Pride Skeleton Grapple do the digging for you by removing roots, stumps, and other timber or debris. These are available in 66" and 76" widths and with 5-1/2" spacing between the teeth, smaller debris is sifted easily. Dual hydraulic cylinders on the SGS15 can close at various gaps to handle irregular shapes, and serrated teeth make this grapple a work-horse in storm clean up and land clearing operations. Our Skeleton Grapple also features available bolt-on side panels.



SGS15



SSB15

	SGS1566	SGS1576	SSB1566	SSB1576
<b>Hitch</b>	Skid/Loader Plate Mount		Skid/Loader Plate Mount	
<b>Width</b>	66"	76"	66"	76"
<b>Weight - lbs (kg)</b>	680 (308)	732 (332)	327 (149)	379 (172)
<b>Closed Height</b>	31"		N/A	
<b>Number of Bottom Teeth</b>	12	14	12	14
<b>Spacing of Teeth</b>	5-1/2"		5-1/2"	
<b>Tooth Thickness</b>	3/8"		3/8"	
<b>Working Length of Teeth</b>	35"		35"	
<b>Hydraulic Cylinder</b>	2" x 8" x 1-1/4" Rod		N/A	
<b>Jaw Opening</b>	37"		N/A	
<b>Lower Tine Material</b>	Grade 80		Grade 80	

Color: 



Optional bolt-on side panels.



Serrated teeth design allows for better load gripping.



Optional covers protect hydraulic cylinders and fittings.



Open ends allow for greater capacity.

Make chores around the farm a breeze.



	SGM1566	SGM1572	SGM1578
Hitch	Skid/Loader Plate		
Width	66"	72"	78"
Weight - lbs (kg)	596 (270)	620 (281)	648 (294)
Closed Height	33"		
Number of Bottom Spears	9	9	10
Number of Top Teeth	4		
Spacing of Spears	7-1/2"	8-1/4"	8"
Spearm Diameter	1-3/8"		
Working Length of Spears	30"		
Hydraulic Cylinder	2" x 8" x 1-1/4" Rod		
Jaw Opening	40"		

Color: 

A Land Pride Manure Grapple is a must-have tool for hay moving, barn cleaning, or general yard maintenance, just to name a few of its many uses. Available in widths from 66" to 78" with 9 to 10 spears, this grapple will make chores around the farm a breeze.



Single, 2" x 8" Cylinder with 1-1/4" rod.  
All pivot points feature 1-1/4" greasable pins.



Hydraulic hoses are sheathed and tucked neatly into the frame for safety.



## Clean large areas with less effort.

Available in 3 sizes, the Land Pride Angle Broom is designed for use in construction site cleanup, road maintenance, light snow removal on paved surfaces, cart path maintenance, and turf scalping operations prior to overseeding. An optional dust control curtain or optional spray system is available for areas where dust control is desired or mandated.

- Poly, steel or combo bristles
- Also good for light snow removal
- Spring-loaded for smooth operation
- Support stands for storage

**Now Available in  
60", 72" & 84"**



AB72 Shown with optional Dust Suppression System, Shroud Extension, and Rubber Deflector

	AB60	AB72	AB84
Hydraulic GPM Range	12-30 GPM		
Hitch	Skid/Loader Plate		
Sweeping Width (cm)	60" (152)	72" (183)	84" (213)
Weight - lb (kg)	800 (363)	854 (387)	930 (422)
	With High Flow Motor, Hydraulic Angling & Combination Broom		
Hydraulic Motor	18 or 25 cu. inch		
Maximum Angle	30° Left or Right, Manual or Optional Hydraulic Angling		
Brush Diameter	32"		
Brush Rotor Shaft	Quick Change Broom Core with No Hydraulic Breakage in Changeover		
Brush Bristle Type	100% Poly or 100% Metallic or 50% Poly and 50% Metallic		
Brush Speed Range	100-230 RPM		
Options	Metal Shroud Extension Water Induced Dust Suppression System Marker Indicators Rubber Dust Deflector Hydraulic Angling		

Color:



AB84

## Easy Handling of Round or Square Bales from a Name You Trust.

The BS10 & BS20 Series Bale Spears can be attached to CTLs, skid steers, or tractor loader arms fitted with a skid mounting plate. BSE units fit the Euro-Hitch plates. The single-spear BS10 utilizes two smaller stabilizer spears to keep bales from rotating on the main spear and feature a 3,000 lb. lifting capacity. The dual-spear BS20 features two 45" spears that perform well on round or square bales. The BS20 lifting capacity is 3,000 lbs. Both units are American-made and have a 1-year limited warranty.



	BS10	BSE10	BS20	BSE20
<b>Hitch</b>	Skid/Loader Plate	Euro Hitch	Skid/Loader Plate	Euro Hitch Plate
<b>Lift Capacity - lb (kg)</b>	3,000 (1,360) at 24" from face of frame			
<b>Spear Length</b>	44-1/2" Upper, 19" Lower		44-1/2"	
<b>Weight - lb (kg)</b>	156 (71)	168 (76)	196 (89)	208 (94)
<b>Spear Construction</b>	Forged		Forged	

Color:

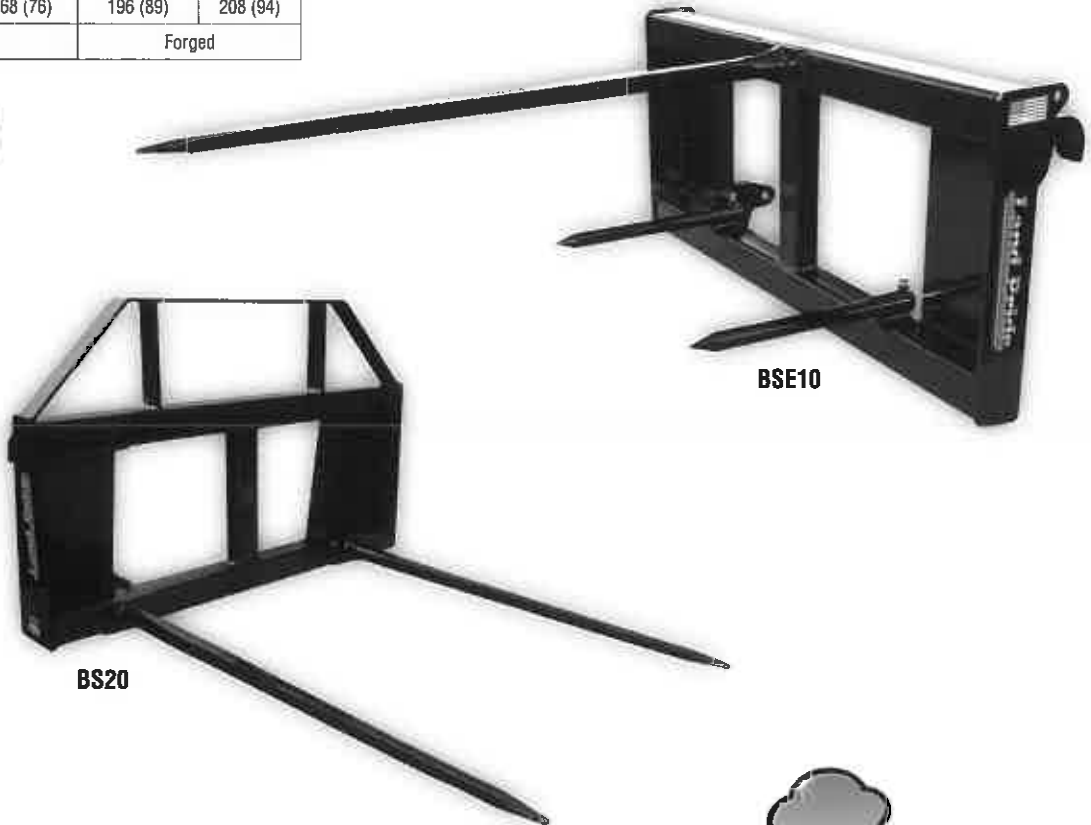

BS20

BSE10





Turn your skid steer or tractor into a forklift for expanded material handling capability.

Land Pride Bucket Mounted Pallet Forks have the capability of turning your tractor or skid steer bucket loader into a forklift for expanded material handling capability.

Land Pride's PFL Series Pallet Forks have uses in a wide variety of applications – from farms to small retail operations. They have the capability of quickly and conveniently turning your skid steer or loader equipped with a skid adapter plate into a forklift, expanding your material handling capability. With capacities from 2,100 lbs to 6,400 lbs, you'll find that these quality Land Pride attachments will save you time and money.

## BUCKET MOUNTED

	PF10	PF20
Hitch	Bucket Mounted	
Lift Capacity - lb (kg)	1,000 (454)	2,000 (907)
Tine Length	31-5/8"	35-5/8"
Weight - lb (kg)	55 (25)	55 (29)
Tine Width	3"	
Tine Height	2"	
Threaded Clamp Rod	1-1/4" - 7"	
Throat Opening	1-1/2"	
Throat Depth	10 3/4"	
Sliding Clamp Handles	9" Arm Length (Center of Screw to End of Arm)	

Color: 

## SKID STEER OR FRONT LOADER PLATE

	PFL2042	PFL3042	PFL3048	PFL454*	PFL5548	PFL5560	PFL6448	PFL6460
Hitch	Skid/Loader Plate			Skid/Loader Plate or Euro Hitch				
Lift Capacity - lb (kg) (per set of 2)	2,100 (952)	3,000 (1,360)	3,000 (1,360)	4,500 (2,041)	5,500 (2,494)	5,500 (2,494)	6,400 (2,902)	6,400 (2,902)
Tine Length	42"	42"	48"	48"	48"	60"	48"	60"
Frame Width w/Step	50"			50"	50"	50"	64-1/2"	64-1/2"
Weight - lb (kg)	330 (150)	340 (154)	358 (162)	412 (187)	436 (198)	482 (219)	888 (311)	744 (337)
Tine Width	4"			4"	4"		4-3/4"	
Tine Height	1"	1-1/4"	1-1/4"	1-1/2"	1-3/4"		1-3/4"	

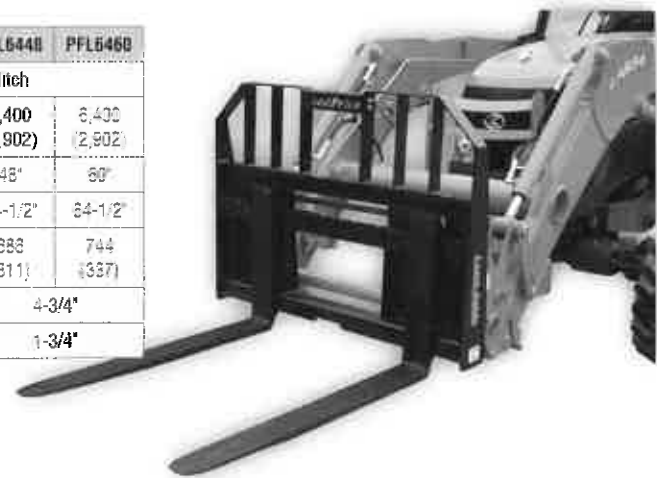

Color: 

- Spring loaded toggle fork position lock
- 3/16" Backframe guard
- Removable top center bracket for walk through

## Get the most out of your Skid Steer.



The SA20 fills a need for users that need a quality skid steer post hole attachment but don't require our heavy-duty design of our commercial-grade SA35. This lighter planetary drive Skid Auger is ideal for land owners, landscapers, hobby farmers, or contractors.

The Land Pride SA20 Skid Auger digs holes from 9" to 36" in diameter and up to 48" deep or deeper with available auger extensions. With 10 different augers available – 7 double flight augers from 9" to 36" and 3 tree augers in 24", 30", and 36" – the SA20 is a versatile and dependable tool.



See pg. 79 for additional Hydraulic Post Hole Diggers.

	SA20	SA35
<b>Hitch</b>	Skid/Loader Plate	
<b>Output Shaft (cm)</b>	2" (5 08) Hex	2" (5 08) Hex or 2-9/16" OD
<b>Weight - lb (kg)</b>	162 (73)	435 (197)
<b>Drive</b>	Hydraulic	Hydraulic
<b>Hydraulic Requirements</b>	6-30 gpm	10-25 gpm
<b>Hydraulic Hose</b>	Optional	Standard
<b>Max Auger RPM</b>	84	
<b>Auger Length</b>	50-3/4" (9" is 49" length)	
<b>Auger Sizes</b>	9", 12", 15", 18", 24", 30" or 36"	
<b>Tree Auger</b>	24", 30" or 36"	
<b>Fighting Thickness</b>	5/16"	
<b>Options</b>	8' or 24' Hose, Flat Face Couplers, Skid/Loader Plate, 3 Motor Options, Auger Extensions	Auger Extension

See dealer for complete warranty information.

Color: 



Land Pride's 36" auger is perfect for planting ball-rooted trees.



Quickly and efficiently bore holes for posts, poles, or trees with a Land Pride SA35 Skid Auger. Our skid steer-mounted Post Hole Diggers offer high torque output, a planetary gearbox, 2" hex or 2-9/16" round output shafts, and augers sized 9" - 36" – our 36" auger is perfect for planting ball-rooted trees. The 9" auger checks in at 46" in length with all other Land Pride augers measuring 48" in length. Land Pride Skid Augers offer a universal fit to most skid steers and tractor front loader plates, and increased maneuverability as the augers are able to reach over fences or other obstructions.





The Skid Steer Mounted Powered Rake can clean up construction sites, tear out unwanted growth, level and grade, and work up the soil to leave a picture perfect seedbed. Designed to attach to most late model skid steer units, a Land Pride Powered Rake is a great way to increase your investment in your skid steer.

## Prepare soil quickly while reducing the labor.

	SR2672	SR2690
<b>Hydraulic Requirement</b>	12-19 GPM	15-23 GPM
<b>Hydraulic Pressure Range</b>	2250-3500 PSI	2250-3500 PSI
<b>Hitch</b>	Skid/Loader Plate	
<b>Working Width (cm)</b>	72" (183)	90" (228)
<b>Machine Weight - lb (kg)</b>	930 (422)	1,200 (545)
<b>Material Control Deflector (cm)</b>	2 Each - 1/2" x 5" Hard Urethane (1.27 x 12.70)	
<b>Roller</b>	9-3/8" Diameter with 3/4" x 1-1/2" Carbide Tipped Studs	
<b>Roller Speed</b>	170-270 RPM	
<b>Drive Chain</b>	#50 Double Continuous Roller Chain, High Tensile, Enclosed in Oil Bath	
<b>Angle Adjustment</b>	22° Left, 18° Right Forward or Reverse	
<b>Angle Cylinder</b>	2" x 8"	
<b>Gauge Wheels</b>	16.5" x 8.5" Air Tires with Sealant and 3/4" Roller Bearings and Spacer Height Adjustment	
<b>Skid Shoes</b>	Replaceable	



Height adjustment is simple on the air-filled gauge wheels and allows for perfect results in a variety of soils.

Carbide-tipped, studded roller does an excellent job removing old growth, as well as pulverizing clods to a consistent size.

**Color Options:** 

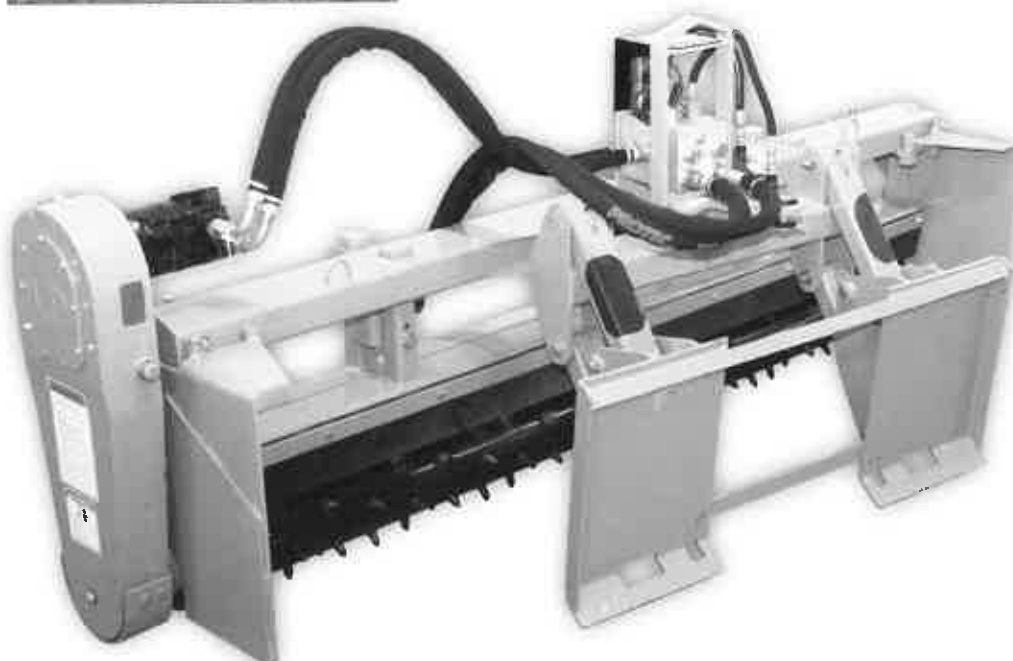

## Expand the versatility of your skid steer or track loader.

The SC26 Skid Steer Cutter has an eye pleasing smooth top design for easy maintenance and clean running. Attachment is made quick and easy with the standard universal skid steer floating-hitch mounting plate. The float capability makes operation very user friendly over uneven ground.

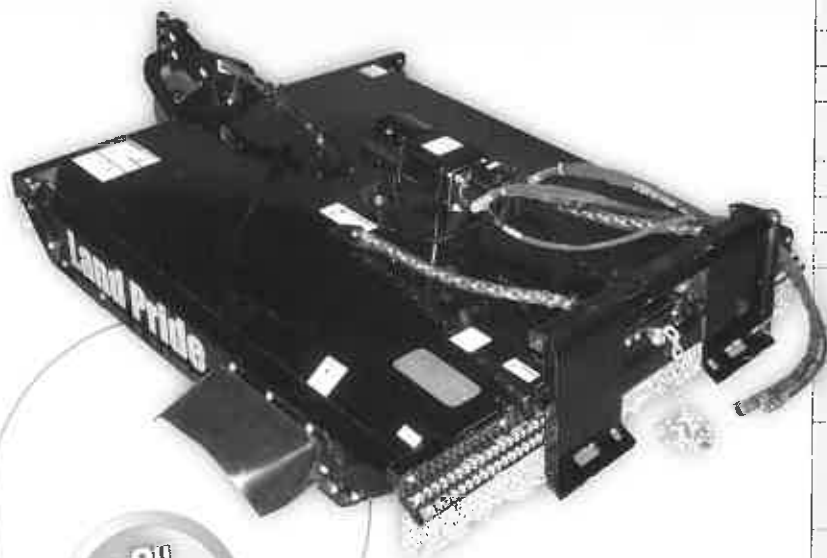

2" CUTTING CAPACITY

2"



SKID STEER

	SC2650	SC2672
Hitch	Skid Steer Mounting Plate	
Working Width (cm)	60" (152)	72" (183)
Overall Width	65-1/2"	78"
Overall Length	73"	91"
Weight - lb (kg)	1,004 (455)	1,347 (611)
Cutting Height	1 5/8" to 18" Infinitely Variable	
Cutting Capacity	2" Diameter	
Blade Rotation	Clockwise	
Blades	1/2" x 4" Updraft, Heavy Duty	
Dishpan	3/16" x 32", Round	
Double Deck Design Construction	Lower Deck: 10 Gauge, Upper Deck: 14 Gauge	
Side Skirt Construction	1/4" Steel	
Safety Guards	Front & Rear Chain	
Deck Lift Ht. Protection	Safety Chain Limiter	
Deck Wear Protection - Optional	Four Corner Mounted Skid Shoes - Standard or Heavy	
Operator Protection	Protective Door Shield	
Gauge Wheel Option	Pivoting & Adjustable Front Mounted Gauge Wheel w/Laminated Tire	
16 GPM Volume Drive Motor (60" Only)	For hyd systems with 11-16 GPM flow at 1500-3500 PSI, 99 ft lbs torque at 2500 PSI	For hyd systems with 11-16 GPM flow at 1500-3500 PSI, 122 ft lbs torque at 2500 PSI
21 GPM Volume Drive Motor	For hyd systems with 17-21 GPM flow at 1500-3500 PSI, 139 ft lbs torque at 2500 PSI	For hyd systems with 17-21 GPM flow at 1500-3500 PSI, 171 ft lbs torque at 2500 PSI
27 GPM Volume Drive Motor	For hyd systems with 22-27 GPM flow at 1500-3500 PSI, 166 ft lbs at 2500 PSI	For hyd systems with 22-27 GPM flow at 1500-3500 PSI, 204 ft lbs at 2500 PSI
16 GPM Volume Motor Max Blade Tip Speed	18,540 FPM	N/A
21 GPM Volume Motor Max Blade Tip Speed	18,850 FPM	17,200 FPM
27 GPM Volume Motor Max Blade Tip Speed	19,000 FPM	18,550 FPM

See dealer for complete warranty information.

Color: 



- Optional front-mounted pivoting gauge wheel w/laminated tire
- 3 GPM volume motors to choose from
- Operator protection door available for skid steer units without doors
- Mounting plate can be centered or offset to right
- Case drain required



## The True Timesavers.

Our Quick-Hitch Systems, designed in accordance with ASAE specifications, fit most Land Pride products and are a real time saver when working on multiple projects. Look for the Quick-Hitch System logo to denote applicable products throughout our product line.



Socket for ball hitch.



The Skid Steer Hitch enables you to operate Cat. 1 or 2 non-PTO tractor implements with your skid steer loader.

	SH35
Skid Steer Hitch	Cat. 1 or 2
Overall Width (mm)	46-7/8" (119)
Overall Height	25"
Weight - lb (kg)	225 (102)
Lock	Automatic on Lower 3-Point Hooks
Top Hook	Adjustable
Adjustable Category	Easily Adaptable for Cat. 1 or 2

Color: 





## Turn large stumps into small chips.



See a Video of the SSG25  
at [landpride.com](http://landpride.com)

The Land Pride Stump Grinder is a great choice for contractors, landscapers, and forestry departments. Skid steer-mounted, this Stump Grinder turns large stumps into small chips. It features durable carbide teeth mounted to a 1/2" cutting wheel that spins up to 1,100 rpm. Fully controllable from inside the cab, this unit has a maximum cutting arc of 55 degrees and depth of 8" below ground. Your skid tool line-up is not complete without a Land Pride Stump Grinder.

	SSG2524
Hitch	Skid Steer Mounting Plate
Overall Mounting Width	48"
Overall Length (w/o Shielding)	60"
Weight - lbs (kg)	540 (245)
Drive System	Hydraulic Motor with Electric over Hydraulics
Hydraulic Requirements	17 to 32 gpm
Angle & Lift Cylinders	3" x 6" Stroke with 1-1/4" Rod Diameter
Hydraulic Lines & Hoses	3/4"
Cutting Wheel	1/2" Thick x 24" Diameter with Carbide Teeth
Number of Carbide Teeth	32
Cutting Wheel Speed	590-1100 RPM
Cutting Arc	55 Degrees
Max. Cutting Depth	8"
Greasable Hinge Points	Yes
Main Frame	6" x 6" x 1/4" Tube

Color: 



Platform shoes provide a stable base from which to operate.



24" Cutting wheel features 32 replaceable carbide-tipped teeth.



## Transform Your Skid Steer & Break New Ground.

Land Pride's NEW Skid Rotary Tiller allows you to transform your Skid Steer into a versatile tilling tool for preparing seed beds, planting food plots, or ripping virgin soil. The Land Pride SRT comes with a host of features and is available in 62" and 76" widths, plus the SRT can be offset 6" to the right for tilling next to fences, building, or sidewalks.

Land Pride's unique, patent-pending Depth Gauge Indicator takes the guess-work out of tilling. Traditional Skid Tillers play a guessing game about tilling depth but Land Pride's Depth Gauge Indicator provides the operator with a clear, visible indication of depth – 2", 4" or full 5.5" depth. Skid shoes are standard.



Land Pride's patent-pending depth gauge indicator provides quick, visual reference of tilling depth.



Sealed rotor bearings are recessed into the end panel to protect against damage from fixed objects.



Ripper shanks with retaining clips.



C-shaped tines are manufactured from hardened steel and feature bi-directional cutting edges.

	SRT62	SRT76
<b>Hydraulic Pressure</b>	Low Flow Motor: 14-23 gpm; Min. 2800 psi/ max of 4500 psi  High Flow Motor: 23-42 gpm; Min. 2000 psi/ max of 4500 psi	High Flow Motor 16-23 gpm* Min. 2800 psi/ max of 4500 psi.  23-42 gpm; Min. 2300 psi/ max of 4500 psi
<b>Hitch</b>	Skid Steer	
<b>Weight - lb (kg)</b>	790 (358)	880 (399)
<b>Motor</b>	Case Drain Std. Increases Power to Tines	
<b>Tilling Width</b>	62"	76"
<b>Overall Width</b>	74-1/2"	88-1/2"
<b>Rotor Diameter</b>	18 3"	
<b>Rotor Speed</b>	Low Flow Motor: 143-245 RPM;  High Flow Motor: 133-244 RPM	High Flow Motor: 16-23 gpm*: 92-133 RPM 23-42 gpm: 133-244 RPM
<b>Tilling Depth</b>	2", 4", 5.5"	
<b>Tines</b>	Forged, Hardened, Bi-Directional, "C"-Shape. 4 per Flange	
<b>Shanks</b>	5 Shanks with Retaining Clips 3/4" x 2-1/2" x 18" Steel Standard Equipment	6 Shanks with Retaining Clips 3/4" x 2-1/2" x 16" Steel Standard Equipment
<b>Depth Gauge Indicator</b>	Standard, Patent Pending	

\* SRT76 High flow motors can be used on skid steers with 16-23 gpm with minimum working pressure of 2600 psi but rotor speed (RPM) will be reduced which could effect tilling performance.



## Easily Remove Trees; Roots and All!

The Land Pride STP15 Tree Puller removes shrubs, saplings, and small trees, pulling them from the ground, roots and all. The serrated teeth make this an ideal tool for removing steel and wood fence posts around the farm or on the job too. The 10" jaw opening allows you to grasp and pull a wide range of trees and posts. With the STP15, chances for regrowth are eliminated without the use of chemicals because you remove the root with the added benefit of minimal ground disturbance.

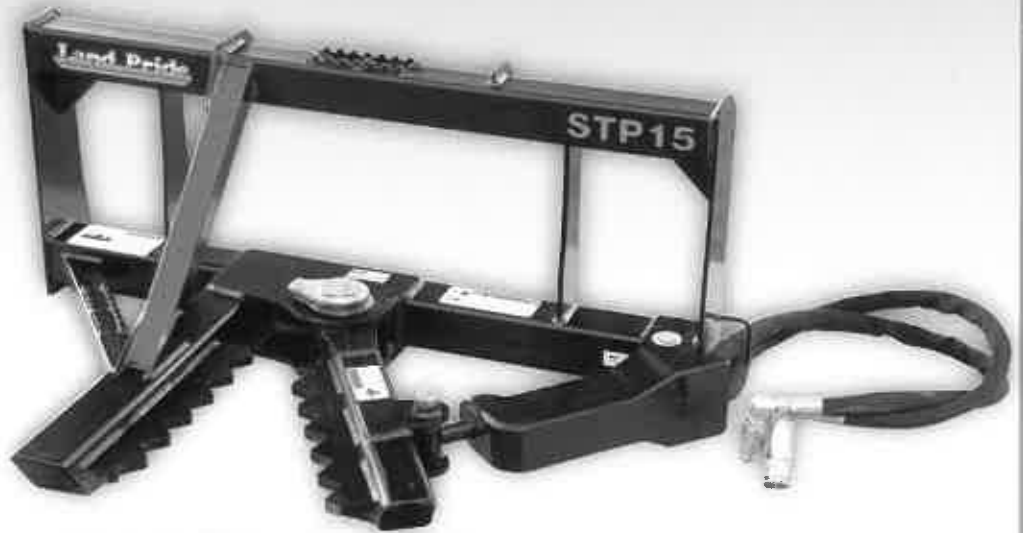

	STP15
Hydraulic Pressure	3000
Hitch	Skid Steer
Weight - lb (kg)	230 (104)
Overall Width	48-1/4"
Cylinder	2"x8"x1-1/8" Welded
Frame	Stout Square Tube
Pincher	16" x 2-3/4" x 5/8"
Pivot Pin	2-1/2" Solid, Greaseable
Mouth Opening	10"
Cylinder Guard	3/16", Included

Color:



## Spring-loaded protection against blade damage.

- Anti-skid, serrated mounting step
- Steel or poly blade mounted wear edge
- Skid shoes to help protect the snow covered surface
- Blade marker helps keep an eye on the blade edge



	TB2596	TB25108
<b>Horsepower</b>	30-80 HP	
<b>Hitch</b>	Skid/Loader Plate	
<b>Working Width (cm)</b>	88" (244)	108" (274)
<b>Maximum Blade Angle</b>	30° Left & 30° Right	
<b>Cutting Width @ 30° Angle</b>	83-1/4"	93-1/2"
<b>Moldboard Thickness</b>	10 Ga.	
<b>Moldboard Height</b>	32"	
<b>Angle Cylinder Size</b>	2" Bore x 6" Stroke	
<b>Maximum Blade Pivot Angle</b>	Floats on Skid Shoes 15° Clockwise & 15° Counterclockwise	
<b>Blade Angle &amp; Pivot Pin</b>	Angle Pin = 2.75" x 6" lg.; Pivot Pin = 2" x 3 1/8" lg.	
<b>Cutting Edge</b>	1/2" x 6" x 88" Blade	1/2" x 6" x 108" Blade
<b>Trip Release Pressure</b>	700 lb	
<b>Skid Steer/Tractor HP</b>	30 to 80 HP	
<b>Weight - lb (kg)</b>	Steel Blade = 657 (298) Poly Blade = 596 (270)	Steel Blade = 684 (310) Poly Blade = 616 (279)
<b>Optional</b>	Hydraulic Angling, Top Rubber Deflector Shield Blade Marker	

Color: 

## Achieve long lasting results with top quality components.

The auger pulls the snow inward as the auger paddles direct it into the high speed impeller. Snow is thrown out of the adjustable chute so you can direct it right where you want it. Because the Snow Blower is making two points of contact with the snow, it can break up hard compacted snow and cover a wider clearing path.

- Hardened Cutting Edge
- Shear Bolt Driveline
- Heavy Duty Chute
- Choice of Skid Shoes
- Telescoping 3-Point

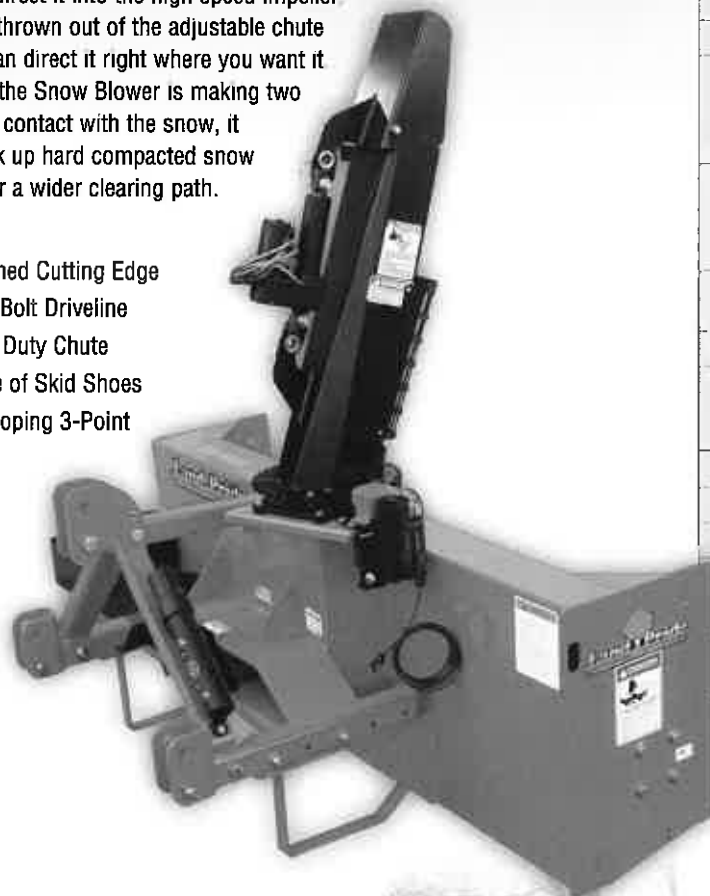

	SB10E1	SB10E4	SB1574
<b>Horsepower</b>	18-32 HP	18-59 HP	30-59 HP
<b>Telescoping Hitch</b>	Cat. 1, Quick-Hitch Adaptable		Cat. 1, Quick-Hitch Adaptable
<b>Working Width (cm)</b>	51" (130)	64" (163)	74" (188)
<b>Weight - lb (kg)</b>	390 (177)	501 (227)	545 (247)
<b>Main Housing Material</b>	12 Gauge		12 Gauge
<b>Side Plate Material</b>	3/16"		3/16"
<b>Optional Cutting Edge</b>	Bolt-on, Reversible & Replaceable Hardened Steel		Bolt-on, Reversible & Replaceable Hardened Steel
<b>Optional Skid Shoes (Choice of)</b>	Outer Bolt-on, Adjustable & Replaceable Wear Plate Bolt-on, Hardened, Replaceable and Reversible Button Style Adjustable & Replaceable		
<b>Impeller</b>	20" Diameter, 4 Blades	24" Diameter, 4 Blades	24" Diameter, 4 Blades
<b>Impeller Housing Depth</b>	6"	8"	8"
<b>Auger</b>	1 - 14" Diameter, 3/8" x 2-1/2" Fighting	1 - 16" Diameter, 3/8" x 2-1/2" Fighting	1 - 16" Diameter, 3/8" x 2-1/2" Fighting
<b>Auger Paddles</b>	2	4	4
<b>Drive Chain</b>	#60 Heavy		#60 Heavy
<b>Chute Opening at Base</b>	8"	10"	10"
<b>Chute Rotation</b>	Sprocket Type, Manual, Electric or Hydraulic		Sprocket Type, Manual, Electric or Hydraulic
<b>Chute Deflector Operation</b>	Manual, Electric or Hydraulic		Manual, Electric or Hydraulic
<b>Driveshaft Shear Bolt</b>	Grade 5 - 1/4 x 20		Grade 5 - 1/4 x 20
<b>PTO Driveline</b>	Cat. 2, Shear Bolt		Cat. 3 Heavy, Shear Bolt

Color Options:



See page 102 for photos of Snow Blower options.

**Ideal for clearing parking lots, long driveways and roadways.**



	SB2584
Horsepower	43-105 HP
Telescoping Hitch	Cat. 1 & 2, Quick-Hitch Adaptable
Working Width (cm)	84" (213)
Weight - lb (kg)	875 (397)
Main Housing Material	12 Gauge
Side Plate Material	3/16"
Optional Cutting Edge	Bolt-on, Reversible & Replaceable Hardened Steel
Optional Skid Shoes (Choice of)	Outer Bolt-on, Adjustable & Replaceable Wear Plates Bolt-on, Hardened, Replaceable & Reversible Button Style Adjustable & Replaceable
Impeller	24" Diameter, 4 Blades
Impeller Housing Depth	10"
Auger	1 - 16" Diameter, 3/8" x 2-1/2" Flighting
Auger Paddles	4
Drive Chain	#60 Heavy
Chute Opening at Base	12"
Chute Rotation	Sprocket Type, Manual, Electric or Hydraulic
Chute Deflector Operation	Manual, Electric or Hydraulic
Driveshaft Shear Bolt	Grade 5 - 1/4 x 20
PTO Driveline	Cat. 3 Heavy, Shear Bolt

Designed for tractors ranging from 43 to 105 HP with Cat. 1 or Cat. 2 hitches, the SB2584 Snow Blowers are designed to remove snow from parking lots, walking paths, homeowner lanes, and driveways. The 84" width, 16" auger, and 24" impeller make short work of the largest snow removal tasks.

Optional front cutting edge and inner or outer depth shoes can be purchased with all models to increase the life of the units and to prevent gouging on uneven surfaces.



Side Wear Plate



Button-style



Outer Skid Shoe

Chute Rotation available in Manual, Hydraulic, or Electric. The chute rotates so you can direct the snow right where you want it.



Manual Chute Rotator



Optional Electric Rotator



Tilt can be easily adjusted manually, or with electric or hydraulic option.

Color Options:



Optional Hydraulic Rotator



## Turn your skid steer or tractor into a snow moving machine.

The SBL25 Series is a front-mount, hydraulic Snowblower that comes in 3 widths up to 84" and features a 24" impeller and 16" auger. The SBL25 turns your skid steer or tractor into a snow moving machine.



Unit is fully hydraulically powered including the impeller, auger, chute rotation, and deflector.



If your tractor cannot produce an adequate amount of hydraulic pressure to operate front-mounted hydraulic implements such as the SBL25 Snow Blower, the Land Pride HRS30 is a great alternative for a hydraulic power source.

	SBL2000	SBL2014	SBL2500
<b>Horsepower</b>	30-60 HP		
<b>Hitch</b>	Skid/Loader Plate		
<b>Working Width (cm)</b>	66"	74"	84"
<b>Weight - lb (kg)</b>	827 (375)	862 (391)	897 (407)
<b>Main Housing Material</b>	10 Gauge		
<b>Side Plate Material</b>	3/16"		
<b>Impeller</b>	20" Diameter	24" Diameter	
<b>Impeller Housing Depth</b>	8"	8"	10"
<b>Impeller Blades</b>	4		
<b>Auger</b>	14" Diameter	16" Diameter	
<b>Auger Paddles</b>	4		
<b>Chute Opening at Base</b>	10"	10"	12"
<b>Chute Rotation</b>	Sprocket Type, Hydraulic		
<b>Chute Deflector Operation</b>	Hydraulic		
<b>Optional Motors</b>	Low, Medium, or High Flow		
<b>Skid Shoes</b>	Outer, Bolt-on, Adjustable & Replaceable		

Color Options:  





# SSP15/25 SNOW PUSHERS

HP  
30-80

HITCH  
Skid/Loader Plate

## Handle large amounts of snow in little time.

Handle anything Old Man Winter throws at you with Land Pride's SSP15 & SSP25 Series Snow Pushers. Skid shoes are designed with AR400 steel for greater wear life and both models have steel wear edges available. The SSP15 offers lift capacity up to 2,000 lbs., while the SSP25 boasts up to 5,000 lbs. of lift capacity. Get more work done quickly with Land Pride Snow Pushers.



	SSP1572	SSP1584	SSP1596	SSP2596	SSP2510	SSP2512
<b>Horsepower</b>	30-60 HP			50-80 HP		
<b>Hitch</b>	Skid/Loader Plate			Skid/Loader Plate		
<b>Working Width (cm)</b>	72"	84"	96"	96"	10'	12'
<b>Carrier Lift Capacity</b>	Less than 2,000 lbs			Less than 5,000 lbs		
<b>Carrier Max Operating Weight</b>	Less than 5,000 lbs			Less than 8,000 lbs		
<b>Moldboard Height</b>	30"			36"		
<b>Moldboard Thickness</b>	10 Gauge			3/16"		
<b>Side Panels w/ Supports</b>	1/4" Plate			5/16" Plate		
<b>Blade Depth</b>	29"			35"		
<b>Replaceable Bottom Wear Edge</b>	1' x 8" Rubber w/ Slotted Holes			1-1/2' x 8" Rubber w/ Slotted Holes		
<b>Mounting Steps</b>	Serrated, on hitch			Serrated, on hitch		
<b>Skid Shoes</b>	AR400 1/2" x 4" Reversible, Adjustable			AR400 1/2" x 4" Reversible, Adjustable		
<b>Option</b>	Pull Back Kit			Pull Back Kit		



The SSP15 offers lift capacity up to 2,000 lbs., while the SSP25 boasts up to 5,000 lbs. of lift capacity.

Color:



### SMALL SEEDS ATTACHMENT -

Utilizes a smaller version of the fluted seed cup to accurately meter tiny seeds like alfalfa, clover, and wildflowers.



## Small Drills, Big Features.

The 3P500 Min-Till Drill is designed to get into places big drills simply can't, like wooded areas, orchards, and vineyards. These excel when seeding into fully prepared and minimum tillage plots. Add the optional small seeds box and plant two different seeds at the same time. The 3P500V offers a low profile box, ideal for orchards and vineyards.

	3P500, 3P500V
Hitch	3-Pt. Cat 1 & 2
Primary Design	Min-Till
Row Spacings	6", 7-1/2"
Number of Openers	9 - 6" spacing, 7 - 7-1/2" spacing
HP Requirements (min)	35 HP
Weight - lbs (kg)	1,200 <sup>+</sup> (544), 1,100 <sup>+</sup> (499)
Working Width	5'
Width	5'
Transport Length	Varies by Tractor
Transport Clearance	Varies by Tractor
Transport Height	Varies by Tractor
Opener Series	00 Series
Opener Travel	6.5"
Opener Depth Range	0-3.5"
Opener Down Pressure	90-180 lbs
Main Box Capacity	10 bu. (8.5 bu. Vineyard)
Small Seed Box	1.2 bu.

### 00 SERIES



The 3P500V offers a low profile box, ideal for orchards and vineyards.



## Gets Into Places Big Drills Simply Can't.

The 3P600 Min-Till Drill features a highly visible seed level indicator, extremely accurate fluted seed cups, V-bottom inserts on the inside of the seedbox that allow all the seed to be metered, and water tight lids that stay open for filling. This model is ideal for wooded areas.

The rugged 00 Series openers provide accurate and consistent seed placement. Openers have 7" of stagger to allow residue to easily flow through the unit. Inside the opener our full length seed tube gently guides the seed all the way to the bottom of the trench and a seed flap makes sure the seed stays in the trench. The trailing press wheels maintain proper opener depth, close the seed trench, and firm the seed into the soil. T-handles quickly adjust the press wheels and allow for small incremental changes in planting depth.

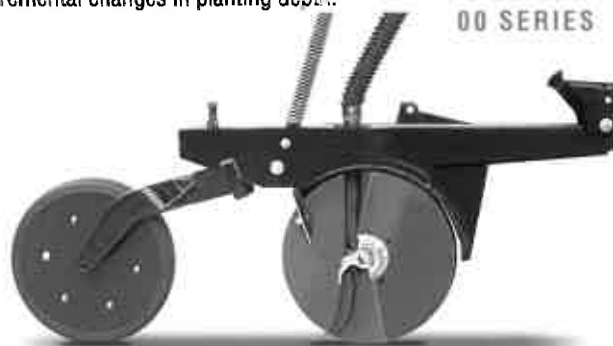

Choice of 2x13 Single Press heels or 3x13 Center Rib Press Wheels

	3P600
Hitch	3-Pt. Cat. 1 & 2
Primary Design	Min-Till
Row Spacings	8" 7-1/2"
Number of Openers	11 - 6" spacing, 9 - 7-1/2" spacing
HP Requirements (min)	40 HP
Weight - lbs (kg)	1,500* (680)
Working Width	6'
Width	6'
Transport Length	Varies by Tractor
Transport Clearance	Varies by Tractor
Transport Height	Varies by Tractor
Opener Series	00 Series
Opener Travel	6.5"
Opener Depth Range	0-3.5"
Opener Down Pressure - lbs	90-180
Main Box Capacity	12 bu.
Small Seed Box	1.44 bu.



## Mounted Versatility.

3P606NT models are 3-point mounted no-till drills, allowing you to get close to field edges and with our proven ground drive no remote hydraulics are needed.

This is a heavy duty no-till drill loaded with features like 450 lbs. pre-loaded coulters, a calibration crank, ground driven metering system, rain tight seed box lids, and a double disk no-till opener. The rugged 6' seeder is ideal for limited space situations and maneuvering among trees and other obstacles. The lead coulters have 4" stagger to aid in residue flow and prepare a mini-seedbed for the 06 series openers to plant into.

All 3P606NT models come standard with a fluted feed box. Add a native grass box for seeding fluffy native grass mixes that include seeds like big and little bluestem and smooth brome. You can further increase your options by adding a small seeds box; a smaller version of our standard fluted feed box used for clover and alfalfa. Add both and seed 3 different types of seed and rates, all at the same time!



COMPACT DRILLS



	3P606NT
Hitch	3-Pt. Cat 2
Primary Design	No-Till
Row Spacings	7-1/2"
Number of Openers	9
HP Requirements (min)	60 HP
Weight - lbs (kg)	2,280 * (1,034)
Working Width	6'
Width	6'
Transport Length	Varies by Tractor
Transport Clearance	Varies by Tractor
Transport Height	Varies by Tractor
Opener Series	06 Series
Opener Travel	6.5"
Opener Depth Range	0-3.5"
Opener Down Pressure - lbs	90-180
Coulters	5/8" Turbo or 5/16" Fluted
Coulters Pre-Load - lbs	450
Main Box Capacity	12 bu
Small Seed Box	1.44 bu
Native Grass Box	6 bu

### 06 SERIES



5/8" Turbo Blade for maximum penetration or 5/16" Fluted Blade for pasture renovation and low soil disturbance



## End Wheel Efficiency.

The 6' Pull-type No-Till Drill (606NT) features an end wheel design that reduces side-loading on openers when operated on contours and curves, eliminating premature opener wear.

With the optional native grass and small seeds box this machine is quite capable in pasture renovations and food plot seeding. Other features like heavy duty coulters, calibration crank, central grease bank, lock-out hubs for transport, and optional weight brackets create a system designed for long-term dependability and productivity in a broad range of seeding applications.

606NT	
Hitch	Pull-Type
Primary Design	End Wheel No-Till
Row Spacing	7-1/2"
Number of Openers	9
Tire Size	7.00-15LT
HP Requirements (min)	40 HP
Weight - lbs (kg)	2,700* (1,124)
Working Width	6'
Width	8'6"
Transport Length	11'5"
Transport Clearance	14"
Transport Height	5'1"
Opener Series	06 Series
Opener Travel	6.5"
Opener Depth Range	0-3.5"
Opener Down Pressure - lbs	90-180
Coulter	5/8" Turbo or 5/16" Fluted
Coulter Pre-Load - lbs	450
Main Box Capacity	12 bu
Small Seed Box	1.44 bu
Native Grass Box	6 bu



**5/8" Turbo Blade for maximum penetration or 5/16" Fluted Blade for pasture renovation and low soil disturbance**



**4-SPEED GEARBOXES** - Provides increased accuracy and flexibility of the metering system by giving the operator more choices for drive speed.



**WIDE SEED CUPS** - Exclusive fluted seed cup delivers outstanding accuracy; delivering the rate you choose, evenly and gently.



	<b>800</b>
<b>Hitch</b>	Pull-Type
<b>Primary Design</b>	End Wheel Min-Till
<b>Row Spacings</b>	6", 7-1/2"
<b>Number of Openers</b>	15 - 6" spacing, 12 - 7-1/2" spacing
<b>Tire Size</b>	700-15LT
<b>HP Requirements (min)</b>	45 HP
<b>Weight - lbs (kg)</b>	2,379 (1,079)
<b>Working Width</b>	7'6"
<b>Width</b>	9'8-1/2"
<b>Transport Length</b>	12'
<b>Transport Clearance</b>	9"
<b>Transport Height</b>	5'4"
<b>Opener Series</b>	00 Series
<b>Opener Travel</b>	6.5"
<b>Opener Depth Range</b>	0-3.5"
<b>Opener Down Pressure - lbs</b>	90-180
<b>Main Box Capacity</b>	16 bu
<b>Small Seed Box</b>	2 bu

## Big Performance in a Small Package.

This 8' Min-Till Drill (800) uses the field proven 00 series opener to properly place seed. This rugged opener utilizes 13-1/2" 4mm thick disk blades, full length seed tube and an 18 position T-handle press wheel to precisely control seed depth. Changing the 5-position, centrally located opener down pressure adjustment is quick and easy, ensuring the correct down pressure regardless of the conditions.

Other features include a 1-3/4" fluted feed metering system. It utilizes a 4-speed gear box and adjustable gate opening to accurately set a wide variety of planting rates for crops from alfalfa to peas. You may also add a dry fertilizer and/or a small seeds attachment to tailor the drill to your needs.

Other features include a lock-out hub to free wheel the drive system during transport. Safety lighting, electronic acre meter, lift cylinder with hoses, calibration crank, "V" bottom dividers for easy clean out, and folding tongue are all standard equipment. An optional seed box agitator is available.



**DIGITAL ACREMETERS -**  
LED readout of current acres on machine. Unique design conserves battery power.



**SAFETY LIGHTS -**  
LED lights provide high visibility and safety during transport.



**LOCK OUT HUBS -**  
Disengages all drive components for transport reducing wear and tear.

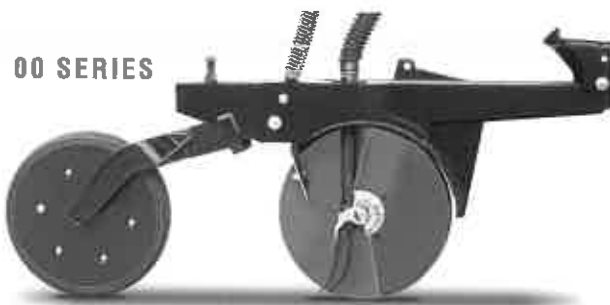

Choice of 2x13 Single Press heels or 3x13 Center Rib Press Wheels





## Narrow Transport.

Our double disk configuration and full length seed tube ensures that the seed is placed consistently at the depth chosen. Additional seed tubes are used to place both native grass and small seeds. This allows three seeds to be planted at separate rates at the same time. Depth control is handled by the 18 position T-handle press wheel adjustment.

The main seed box is a fluted feed design. The seeding rate is set with the four speed transmission and the adjustable gate opening. The optional native grass box uses our proven "picker wheel" to meter the seed. Rates are adjusted by varying the speed of the drive. Lastly, the optional small seeds attachment is a smaller version of our fluted feed system, and seeding rates are set by changing the width of the fluted feed. The ground drive system automatically disengages when lifted, simplifying the unit and enhancing its reliability.

Options also include: dry fertilizer, native grass, small seeds, seed box agitator, and dual seed.

	3P806NT
Hitch	Semi-Mount
Primary Design	No-Till
Row Spacings	7-1/2"
Number of Openers	13
Tire Size	265/70B 16.5
HP Requirements (min)	80 HP
Weight - lbs (kg)	4350* (1,973)
Working Width	8'
Width	8'2"
Transport Length	12'1" w/lift assist
Transport Clearance	Varies by Tractor
Transport Height	7'8"
Opener Series	06 Series
Opener Travel	6.5"
Opener Depth Range	0-3.5"
Opener Down Pressure - lbs	90-180
Coulters	5/8" Turbo or 5/16" Fluted
Coulters Pre-Load - lbs	450
Main Box Capacity	16 bu.
Small Seed Box	1.92 bu.
Native Grass Box	8 bu.
Fertilizer	3 bu.
2nd Main Box	3 bu.



*3P806NT Model Shown With Optional Native Grass and Small Seeds Boxes*



**V-BOTTOM DIVIDERS** - Allows seed to feed from seed box to feeder cup for complete emptying.



**GREASE BANK** - Installed on No-Till machines, so you can service all coulters in centralized locations.



**5/8" Turbo Blade** for maximum penetration or **5/16" Fluted Blade** for pasture renovation and low soil disturbance

	3P1006NT
Hitch	Semi-Mount
Primary Design	No-Till
Row Spacings	7-1/2"
Number of Openers	15
Tire Size	265/70B 16.5
HP Requirements (min)	100 HP
Weight - lbs (kg)	5,460* (2,476)
Working Width	10'
Width	9'8"
Transport Length	13'3" w/lift assist
Transport Clearance	Varies by Tractor
Transport Height	7'8"
Opener Series	06 Series
Opener Travel	6.5"
Opener Depth Range	0-3.5"
Opener Down Pressure - lbs	90-180
Coulters	5/8" Turbo or 5/16" Fluted
Coulters Pre-Load - lbs	450
Main Box Capacity	20 bu.
Small Seed Box	2.40 bu
Native Grass Box	10 bu
Fertilizer	10 bu
2nd Main Box	10 bu

3P1006NT Model Shown With Optional Native Grass and Small Seed Boxes



## 10ft Narrow Semi-Mounted.

The 3P1006NT model is the big brother to the 8' - 3P806NT. At 10' seeding and 10' transport this machine is productive yet can easily get in pasture gates, over bridges, and transport down narrow roads. 2-point mounting and dual hydraulic lift assist wheels in the rear give the drill excellent ground clearance as well.

Non-swiveling coulters allow the 3P1006NT to stay on side hills without drifting. Competitive models use swiveling coulters that tend to run downhill. Two smaller pneumatic tires in front gauge depth for the coulters, as well as, drive the metering systems on the drill.

With the main seed box only the drill weighs 4350 lbs., so it has the weight needed to penetrate tough no-till surfaces. If even more weight is needed an optional weight bracket can be installed to get excellent penetration in the toughest ground.



**MULTIPLE BOX COMBINATIONS** - Start with the standard 2 bu. per ft. main seed box, then add either a 2nd seed box for dual seed, a dry fertilizer box, or a native grass box. Additionally you can add a small seeds box to the main box or add it to the dual seed/fertilizer/native grass box choice.

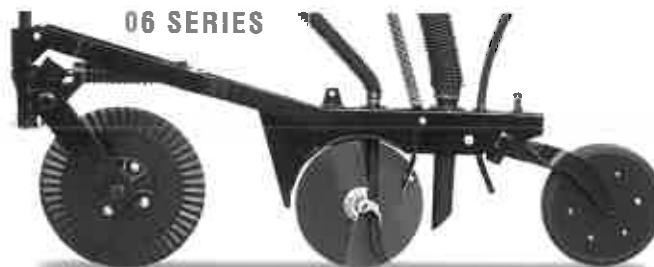

**5/8" Turbo Blade for maximum penetration or 5/16" Fluted Blade for pasture renovation and low soil disturbance**

FAIRPLAIN TRACTOR SALES, INC.  
1169 RIPLEY ROAD  
RIPLEY, WV 25271  
PHONE: (304) 372-9875

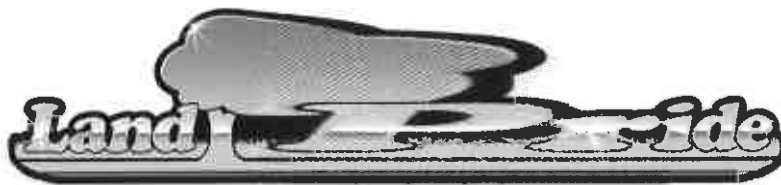

A Division of Great Plains Mfg., Inc.  
1525 E. North St. • P.O. Box 5060  
Salina, Kansas 67401  
Visit our dealer locator at [landpride.com](http://landpride.com)

**LP** *Consistently Leading the Way...*

Box Mowers • All-Purpose Seeders • Angle Brooms • Bale Spears • Box Scrapers • Compact Drills  
Front End Loaders • Crimpers • Disc Harrows • Ditchers • Drag Harrows • Drag Scrapers • Fertilizer Spreaders  
Front End Loaders • Food Plot Seeders • Grading Scrapers • Grapples • Grooming Mowers • Hydraulic Reservoir Kits  
Landscape Rakes • Overseeders • Pallet Forks • Pasture Aerators • Post Hole Diggers  
Front End Loaders • Primary Seeders • Quick-Hitches • Rear Blades • Rotary Cutters • Rotary Tillers  
Front End Loaders • Seed Bed Rollers • Snow Blowers • Snow Pushers • Soil Pulverizers • Spike Tooth Harrows  
Front End Loaders • Stump Grinders • Trip Edge Snow Blades • Wood Chippers • Zero Turn Mowers